



# LATIN AMERICAN

## 4TH INTERNATIONAL CONGRESS ON NATURAL AND APPLIED SCIENCES

EDITORS

MIJAEAL ALTAMIRANO SANTIAGO

ISI VERÓNICA LARA ANDRADE

MARÍA CRUZ CUEVAS ÁLVAREZ

MARCOS PÉREZ MENDOZA

ISBN - 978-625-367-022-1

[WWW.IKSADAMERICA.ORG](http://WWW.IKSADAMERICA.ORG)

# 4TH INTERNATIONAL LATIN AMERICAN CONGRESS ON NATURAL AND APPLIED SCIENCES

March 13-15, 2023 / Rio de Janeiro, Brazil

## EDITORS

Mijael Altamirano Santiago

Isi Verónica Lara Andrade

María Cruz Cuevas Álvarez

Marcos Pérez Mendoza

All rights of this book belong to

IKSAD Publishing House Authors are responsible both ethically and juridically

IKSAD Publications - 2023©

Issued: 25.03.2023

ISBN: 978-625-367-022-1

## **CONGRESS TITLE**

4th International Latin American Congress on Natural and Applied Sciences

## **DATE AND PLACE**

March 13-15, 2023 / Rio de Janeiro, Brazil

## **ORGANIZATION**

IKSAD INSTITUTE

Universidad Abierta y a Distancia UNAD,  
Colombia Universidad Juárez Autónoma de Tabasco,  
México Institute Of Economic Development And Social Research Violence and  
Abuse Studies Platform

## **EDITORS**

Mijael Altamirano Santiago  
Isi Verónica Lara Andrade  
María Cruz Cuevas Álvarez  
Marcos Pérez Mendoza

## **PARTICIPANTS COUNTRY (18 countries)**

TÜRKİYE, INDIA BATNA, BULGARIA, MOROCCO, AZERBAIJAN, PAKISTAN,  
IRAQ, GEORGIA, UZBEKISTAN, NIGERIA, ITALY, ROMANIA, MEXICO, SPAIN,  
ALGERIA, SERBIA, IRAN,

**Total Accepted Article: 76**

**Total Rejected Papers: 13**

**Accepted Article (Türkiye): 32**

**Accepted Article (Other Countries): 44**

**ISBN - 978-625-367-022-1**

# ORGANIZING AND SCIENTIFIC COMMITTEES

**Dra. Felipa Sánchez Pérez**

Universidad Juárez Autónoma de Tabasco, México  
Chairman of the conference

**Dra. Francisca Silva Hernández**

Universidad Juárez Autónoma de Tabasco, México

**Dr. Germán Martínez Prats**

Universidad Juárez Autónoma de Tabasco, México

**Dr. Rafael Ricardo Renteria Ramos**

Universidad Abierta y a Distancia UNAD, Colombia

**Dr. Ragif Huseynov**

Managing Director of Khazar Educational Center, Azerbaijan

**Dr. Raiba Jafarova**

Associate Professor of Azerbaijan State Agricultural University, Azerbaijan

**Dr. Resmiyye Abdullayeva**

Associate Professor of Institute of Economics, Azerbaijan

**Dr. Maral Jamalova**

Assistant Professor of Azerbaijan State University of Economics,  
Azerbaijan

**Bunyamin Seyidov**

PhD student of Institute of Philosophy and Sociology, Azerbaijan



# PTOHO GALLERY

planti - Hall-4

Hall 4 - Observer

H4- K. Ömer TAŞ

H4-S2\_Seyfi Şevik

H4-Duygu Taşkın

Moderator: Eliz...

Moderator: Elizabeth Garcia...

Katılımcılar (9)

Q Katılımcı bul

- H4 H... (Ortak oturum sahibi, ben)
- ME Moderator: Elizabeth Garcia...
- HK H4- K. Ömer TAŞ
- Ö H4-Özlem ÖZKAN ÖNÜR
- F Fernanda
- H-4, Ceren AĞIN GÖZÜKIZIL
- HT H4-Duygu Taşkın
- HB H4-Günay Beyhan
- HŞ H4-S2\_Seyfi Şevik

PRODUCCIÓN DE AGUA POTABLE PARA RIEGO Y CONSUMO HUMANO

UNIVERSIDAD JUÁREZ AUTÓNOMA DE TABASCO

"ESTUDIO EN LA BUENA. ACCIÓN EN LA FE"

PRODUCCIÓN DE AGUA POTABLE PARA RIEGO Y CONSUMO HUMANO

Johan Josueph Velázquez Martínez  
Dra. Elizabeth García Moreno  
Dr. Germán Martínez Prats  
Dra. Francisca Silvia Hernández

Sesi aç Videoyu Başlat Katılımcılar Sohbet Ekran Paylaşımı Kaydı Duraklat/Durdur Reaksiyonlar Uygulamalar Daha fazla Odadan Çık

Tümünü Sessize Al

planti

Hall 4 - Observer

H4- K. Ömer TAŞ

H4-S2\_Seyfi Şevik

Moderator: Elizabeth...

H4-Duygu Taşkın

Katılımcılar (9)

Q Katılımcı bul

- H4 H... (Ortak oturum sahibi, ben)
- HŞ H4-S2\_Seyfi Şevik
- Ö H4-Özlem ÖZKAN ÖNÜR
- EF Est. Fernanda Jazmin Morales G...
- HK H4- K. Ömer TAŞ
- H-4, Ceren AĞIN GÖZÜKIZIL
- HT H4-Duygu Taşkın
- HB H4-Günay Beyhan
- ME Moderator: Elizabeth Garcia Mo...

GELENEKSEL AHSAP SİVİL MİMARLIK ÖRNEKLERİNDE KULLANILAN TEKNİKLERİ: TARAĞLI EVLERİ

STRUCTURE TECHNIQUES USED IN EXAMPLES OF TRADITIONAL ARCHITECTURE: TARAĞLI HOUSES

Latin American Scientific Research Congresses

4. Latin America Uluslararası Doğa ve Uygulamalı Bilimler Kongresi

DÜZCE ÜNİVERSİTESİ

Dr. Özlem ÖZKAN ÖNÜR  
Düzce Üniversitesi, Sanat Tasarım ve Mimarlık Fakültesi, Mimarlık Bölümü  
Düzce University, Faculty of Art, Design and Architecture, Architecture Department

Sesi aç Videoyu Başlat Katılımcılar Sohbet Ekran Paylaşımı Kaydı Duraklat/Durdur Reaksiyonlar Uygulamalar Daha fazla Odadan Çık

Tümünü Sessize Al

# PTOHO GALLERY

planti - Hall-4

Muzisyenler için Orjinal Ses: Kapalı Kaydediliyor...

Görüntüle

Katılımcılar (8)

Q Katılımcı bul

- H4 H... (Ortak oturum sahibi, ben)
- H-4, Ceren AĞIN GÖZÜKİZİL
- HK H4- K. Ömer TAŞ
- HT H4-Duygu Taşkın
- HB H4-Günay Beyhan
- Ö H4-Özlem ÖZKAN ÖNÜR
- HŞ H4-S2\_Seyfi Şevik
- ME Moderator: Elizabeth García Mo...

Müzenin amacı;

- Louvre'yu rahatlatmak
- Müzenin toplam ziyaretçi sayısını artırıp, Fransa'nın kuzeyindeki şehirlerin ekonomisini canlandırmak

2012'de açılan müzenin, açılışında 600 kadar eserin sergilenmesi ve yılda en az 500.000 ziyaretçi beklentisi bulunmaktadır

LOUVRE MÜZESİ  
Lens Louvre Müzesi (Lens-Fransa)

H-4, Ceren AĞIN GÖZÜKİZİL

Sesi aç Videoyu Başlat Katılımcılar Sohbet Ekran Paylaşımı Kaydı Duraklat/Durdur Reaksiyonlar Uygulamalar Daha fazla Odadan Çık

Tümünü Sessize Al

planti - Hall-4

Hall 4 - Observer kave koorehpa... Moderator: Hall-4, Dr Sy... Sorüntüle

Muzisyenler için Orjinal Ses: Kapalı Kaydediliyor...

Katılımcılar (6)

- H4 H... (Ortak oturum sahibi, ben)
- MH Moderator: Hall-4, Dr Syed ...
- V Hall 4 session 1, Vinod Kumar
- KK kave koorehpa-\_Hall4
- LH lamie hall 4
- KK kave koorehpa-hall4

**M. oleifera seed meal** **M. oleifera leaf meal**

Crude protein 34 to 38 %

Essential amino acids, especially methionine, cystine, tryptophan

8.57% crude fat

Saturated and unsaturated fatty

(Chuks et al., 2013; Olagbemde et

promising protein source at low levels, crude protein 25% to 32%

High amount of other minerals such as Ca, Cu, Zn, K, P, Mg & Na.

Important source of vitamins and minerals

Rich in carotenoids, ascorbic acid

Sesi aç Videoyu Başlat Katılımcılar Sohbet Ekran Paylaşımı Kaydı Duraklat/Durdur Reaksiyonlar Uygulamalar Daha fazla Odadan Çık

Tümünü Sessize Al

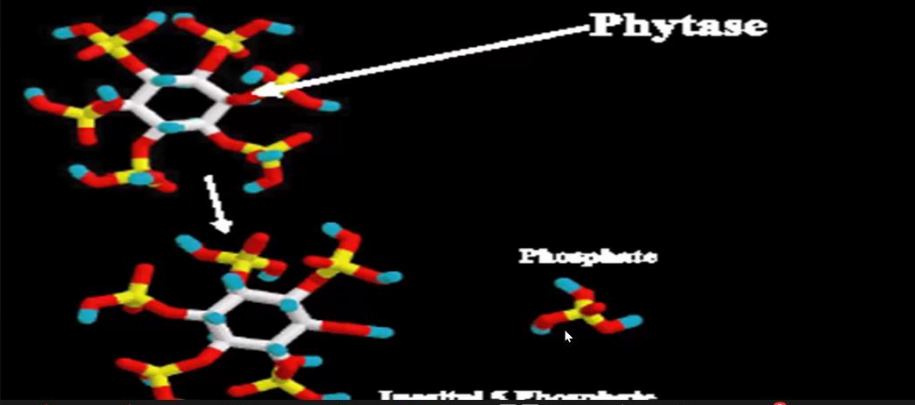
# PTOHO GALLERY

planti - Hall-4

Hall 4 - Observer kave koorehpaz... kave koorehpa... Moderator: Hall...  
Hall 4 - Observer kave koorehpaz-hall4 kave koorehpaz-Hall4 Moderator: Hall-4, Dr Sy... lamie hall 4

Muzisyenler için Orjinal Ses: Kapalı Kaydediliyor...

## Action of Phytase Enzyme: Release of Phosphate from Phytate



GCUF

Katılımcılar (6)

- H4 H... (Ortak oturum sahibi, ben)
- MH Moderator: Hall-4, Dr Syed ...
- V Hall 4 session 1, Vinod Kumar
- KK kave koorehpaz-Hall4
- LH lamie hall 4
- KK kave koorehpaz-hall4

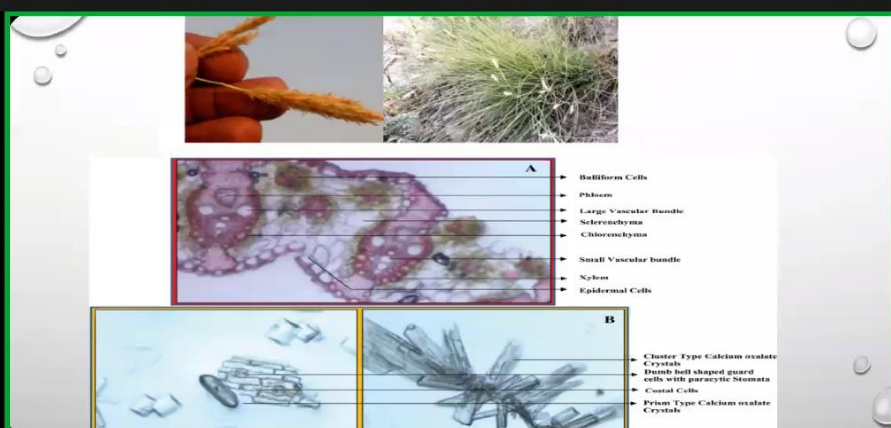
Sesi aç Videoyu Başlat Katılımcılar Sohbet Ekran Paylaşımı Kaydı Duraklat/Durdur Reaksiyonlar Uygulamalar Daha fazla Odadan Çık

Tümünü Sessize Al

planti - Hall-4

Hall 4 - Observer kave koorehpa... Moderator: Hall...  
Hall 4 - Observer kave koorehpaz-hall4 kave koorehpaz-Hall4 Moderator: Hall-4, Dr Sy... Hall 4 session 1, Vinod K...

Muzisyenler için Orjinal Ses: Kapalı Kaydediliyor...



Bulliform Cells  
Phloem  
Large Vascular Bundle  
Sclerenchyma  
Chlorenchyma  
Small Vascular bundle  
Scleren  
Epidermal Cells

Cluster Type Calcium oxalate Crystals  
Dumb bell shaped guard cells with paracytic Stomata  
Conical Cells  
Prism Type Calcium oxalate Crystals

Katılımcılar (7)

- H4 H... (Ortak oturum sahibi, ben)
- V Hall 4 session 1, Vinod Kumar
- MH Moderator: Hall-4, Dr Syed Mak...
- k H4-kübra ikinci
- KK kave koorehpaz-Hall4
- LH lamie hall 4
- KK kave koorehpaz-hall4

Sesi aç Videoyu Başlat Katılımcılar Sohbet Ekran Paylaşımı Kaydı Duraklat/Durdur Reaksiyonlar Uygulamalar Daha fazla Odadan Çık

Tümünü Sessize Al



# PTOHO GALLERY

Hall-6, Observer H-6, Fikret SONMEZ H6-Kahraman K... H6-Melih YAZICI Hall-6,Vekil SARI

Katılımcılar (9)

Q. Katılımcı bul

H... (Ortak oturum sahibi, ben)

H6-Melih YAZICI

H-6 - Observer (Ortak oturum sahibi)

baris cetin

H-6, Abdullah ERDEMİR

H-6, Fikret SONMEZ

H6-Kahraman KÜÇÜK

Hall-6 Session-1-Cem Baki

Hall-6,Vekil SARI

DEVELOPMENT OF FLAME RETARDANT PA6 AND PA66 COMPOSITES ACCORDING TO RAILWAYS EN 45545-2 STANDARD

CERTIFICATION EN 45 545

Melih YAZICI EPSAN PLASTIC

Hall-6, Observer H-6, Fikret SONMEZ H6-Kahraman K... Hall-6,Vekil SARI Hall-6, shaymaa awad H-6, Abdullah ERDEMİR...

Katılımcılar (10)

Q. Katılımcı bul

H... (Ortak oturum sahibi, ben)

H-6, Fikret SONMEZ

H-6 - Observer (Ortak oturum sahibi)

baris cetin

H-6, Abdullah ERDEMİR

H6-Kahraman KÜÇÜK

H6-Melih YAZICI

Hall-6 Session-1-Cem Baki

Hall-6, shaymaa awad

Hall-6,Vekil SARI

Latin American International Congress on Natural and Applied Sciences-IV

Sonuçlar Results

Takım Ömrü Ölçüm Sonuçları Tool Life Measurement Results

Takım aşınması incelemesi her paso sonunda yapılmış ve yedi farklı inceleme yapılmıştır. Tool wear inspection was performed at the end of each pass and seven different inspections were made.

TINAD UNIVERSIDAD JUÁREZ

3 atanmamış katılımcı


# PTOHO GALLERY

Hall-6, Observer  
Hall-6, Vekil SARI

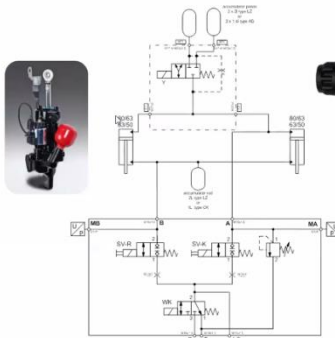
Kaydediliyor...

## LITERATURE SEARCH

### Tractor Applications



Case Magnum und New Holland T8000



Compact products are mostly used in cabin applications and there are a wide variety of models

3 atanmış katılımcı

Katılımcılar (9)

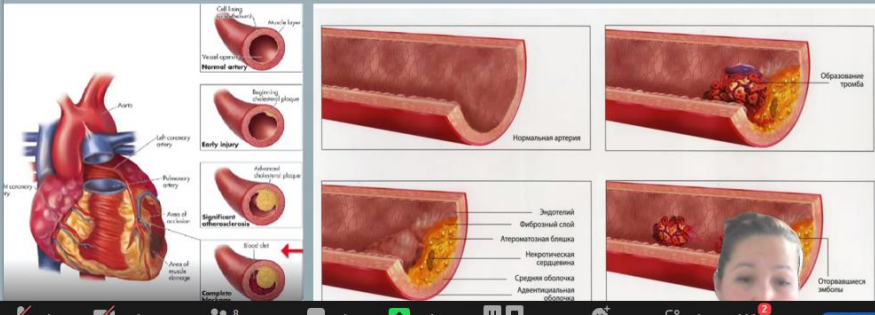
Q Katılımcı bul

- HO H... (Ortak oturum sahibi, ben)
- HK H6-Kahraman KÜÇÜK
- BC baris cetin
- H-6, Abdullah ERDEMİR
- HF H-6, Fikret SONMEZ
- HY H6-Melih YAZICI
- C Hall-6 Session-1-Cem Baki
- Hall-6, shaymaa awad
- HS Hall-6,Vekil SARI

Hall-7, Observer  
H7-Cemilenur A...

Kaydediliyor...

The progressive development of an atherosclerotic plaque, especially the addition of its complications, leads to the development of a critical stenosis of the affected artery and leads to ischemia of the corresponding organ.



Normal artery

Образование тромба

Нормальная артерия

Эндотелий  
Фиброзный слой  
Атеросклеротическая бляшка  
Некротическая сердцевина  
Средняя оболочка  
Адвентициальная оболочка

Отправляющиеся тромбы

Katılımcılar (8)

Q Katılımcı bul

- HO H... (Ortak oturum sahibi, ben)
- H H7 - Aigul Myrzabayeva
- HD H-7 Dr. Dilara ÜLGER ÖZBEK
- HS H7- Süleyman Görğüş
- HA H7-Cemilenur Ataş
- Hall-7, Nurşin Aydın
- MH Moderator: Hall-7, Cüneyd YAVAŞ
- OG Oya Güven

Sesi aç Videoyu Başlat Katılımcılar Sohbet Ekran Paylaşımı Kaydı Duraklat/Durdur Reaksiyonlar Uygulamalar Daha fazla Odadan Çık

Tümünü Sessize Al

# PTOHO GALLERY


Hall-7, Observer Hall-7, Cüneyd... H7 - Aigul Myrz... H7-Cemilenur A... Görüntüle

Kaydediliyor...

## What Is ICP-MS?

(Inductively Coupled Plasma Mass Spectrometry)

➤ It is an advanced analytical instrument that; can quickly analyze many elements simultaneously in many sample types, at low concentrations ( $\mu\text{g/L}$ ,  $\text{ng/L}$ ).



Katılımcılar (8)

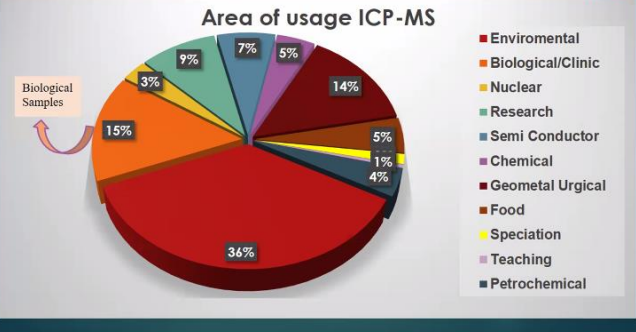
Q Katılımcı bul

- HO H... (Ortak oturum sahibi, ben)
- HD H-7 Dr. Dilara ÜLGER ÖZBEK
- H- H7 - Aigul Myrzabayeva
- HS H7- Süleyman Görgüç
- HA H7-Cemilenur Ataş
- HC Hall-7, Cüneyd YAVAŞ
- Hall-7, Nurşin Aydın
- OG Oya Güven

Kaydediliyor... Görüntüle

## ICP-MS USAGE AREA

Area of usage ICP-MS



Usage Area	Percentage
Enviromental	36%
Biological/Clinic	15%
Nuclear	14%
Research	9%
Semi Conductor	7%
Chemical	5%
Geometal Urgical	5%
Food	4%
Speciation	3%
Teaching	1%
Petrochemical	1%

Biological Samples

H7 - Aigul Myrz... H7 - Aigul Myrzabayeva

Hall-7, Observer Hall-7, Observer

Hall-7, Cüneyd... Hall-7, Cüneyd YAVAŞ

Hall-7, Nurşin Aydın Hall-7, Nurşin Aydın

H7 - Aigul Myrz... H7 - Aigul Myrzabayeva

Katılımcılar (8)

Q Katılımcı bul

- HO H... (Ortak oturum sahibi, ben)
- HD H-7 Dr. Dilara ÜLGER ÖZBEK
- H- H7 - Aigul Myrzabayeva
- HS H7- Süleyman Görgüç
- HA H7-Cemilenur Ataş
- HC Hall-7, Cüneyd YAVAŞ
- Hall-7, Nurşin Aydın
- OG Oya Güven



# PTOHO GALLERY

Kaydediliyor... NEW Videoları yeniden sıralamak için sürükleyip bırakın Görüntüle

## Operating Principle

► The main principle of the method is that ;

1. Ionization of the sample in solution by argon plasma, which is heated to 8,000 - 10,000 K by electromagnetic induction



2. It includes the steps of measuring element concentrations with a mass spectrometry (MS) detector unit according to the mass/charge ( $m/z$ ) ratio.

Hall-7, Observer  
Hall-7, Observer

Hall-7, Cüneyd...  
Hall-7, Cüneyd YAVAŞ

Hall-7, Nurşin Aydın  
Hall-7, Nurşin Aydın

H7 - Aigul Myrz...  
H7 - Aigul Myrzabayeva

Katılımcılar (8)


Q Katılımcı bul

- HO H... (Ortak oturum sahibi, ben)
- HD H-7 Dr. Dilara ÜLGER ÖZBEK
- H- H7 - Aigul Myrzabayeva
- HS H7- Süleyman Görgüç
- HA H7-Cemilener Ataş
- HC Hall-7, Cüneyd YAVAŞ
- Hall-7, Nurşin Aydın
- OG Oya Güven

Hall-4, Observer  
Hall-4, Observer  
Moderator: Hall-4, Monica...  
Ulzhan Baiturina

HALL 4, Samah...  
H4-Vu Thi Anh...  
HALL 4, Samah Bouhazama...  
H4-Vu Thi Anh Hong

## Albert Camus



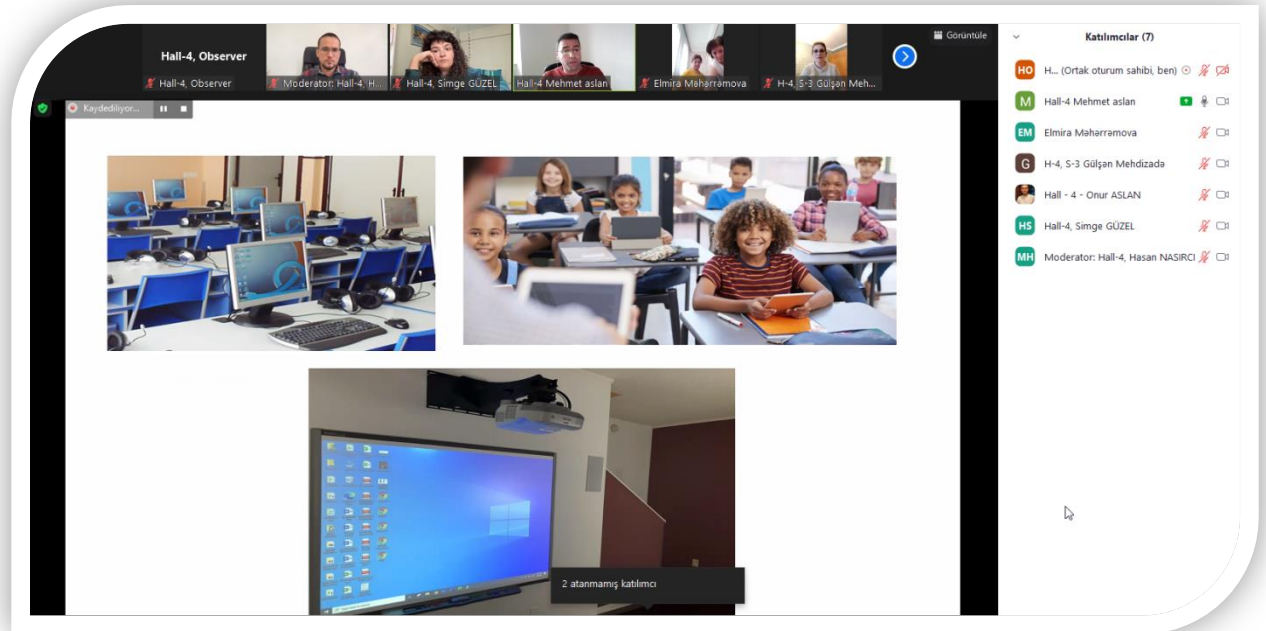
1913 - 1960

- **Born in 1913 in Algeria.**
- **French novelist, essayist, and playwright.**
- **Best known for such novels as *L'Étranger* (1942; *The Stranger*), *La Peste* (1947; *The Plague*), and *La Chute* (1956; *The Fall*) and for his philosophical essays *Le Mythe de Sisyphe* (1942; *The Myth of Sisyphus*) and *L'Homme révolté* (1951; *The Rebel*).**
- **He received the 1957 Nobel Prize for Literature.**
- **Camus died in a car accident in 1960.**

Katılımcılar (5)

- HO H... (Ortak oturum sahibi, ben)
- MH Moderator: Hall-4, Monica ...
- HT H4-Vu Thi Anh Hong
- H4 HALL 4, Samah Bouhazama
- Y Ulzhan Baiturina

# PTOHO GALLERY



# PTOHO GALLERY

Advantages of mobile devices in language learning  
(Aslan, M. 2023)

Learning is more memorable  
*Thanks to visual and audial materials*

Learning is faster  
*Thanks to the internet, accessing information quickly regardless of location and time.*

Learning is more fun  
*Thanks to gamification*

Learning is easier  
*Thanks to portability*

Learning is cheaper  
*Thanks to online sources*

Hall-4 Mehmet aslan

Hall-4, Observer

Hall-4, Observer Moderator: Hall-4, Hasa Hall - 4 - Onur ASLAN Hall-4 Mehmet aslan Elmira Maharramova Hall-4, Simge GÜZEL

Latin American Scientific Research Congresses  
March 13-15, 2023

**HOW AWARE ARE WE  
OF THE EMOTIONAL  
LABOR OF TEACHERS?**  
DR. HASAN NASIRCI, TURKIYE

2 atanmamış katılımcı

Katılımcılar (6)

- HO H.. (Ortak oturum sahibi, ben)
- MH Moderator: Hall-4, Hasan N..
- EM Elmira Maharramova
- Hall - 4 - Onur ASLAN
- M Hall-4 Mehmet aslan
- H5 Hall-4, Simge GÜZEL

# PTOHO GALLERY

**2. The results of the survey of journalism genre in Vietnam on the Issue of Customs reform and modernization**

The journalism genre in groups of topics and content according to 5 groups

Topics are mostly reflected by the press in the news and reflection articles.

Genre	Objective, Solution, Benefit	Customs Law and Policies	Modern Technology	Customs Accompanying with Businesses	Shortcomings, Problems and Recommendations
News	~10	~10	~10	~10	~10
Interviews	~10	~10	~10	~10	~10
Reportages	~10	~10	~10	~10	~10
Reflections	~60	~60	~60	~60	~60
Analysis/research articles	~60	~60	~60	~60	~60
Legal Q&A text quotes	~10	~10	~10	~10	~10

Click to add notes

Slide 13 of 17 "Office Theme" English (United States) 31%

**Katılmalar (6)**

- HO H... (Ortak oturum sahibi, ben)
- HT H4-Vu Thi Anh Hong
- H4 HALL 4, Samah Bouhazama
- MH Moderator: Hall-4, Monica Garouli
- Y Ulzhan Baturina
- ZA Zhanargul Azkenova, Kazakhstan

**ANALYSIS OF RESEARCH ON UNEMPLOYMENT ANXIETY OF UNIVERSITY STUDENST**

**ÜNİVERSİTE ÖĞRENCİLERİNİN İŞSİZLİK KAYGISI ÜZERİNE YAPILAN ARAŞTIRMALARIN ANALİZİ**

**PRESENTER: SİMGE GÜZEL & PROF. DR. İLKNUR MAY**

7 atanmış katılımcı

**Katılmalar (5)**

- HO H... (Ortak oturum sahibi, ben)
- HS Hall-4, Simgе GÜZEL
- MH Moderator: Hall-4, Hasan NASIRCI
- EM Elmira Maharramova
- Hall - 4 - Onur ASLAN



**Latin American Scientific Research Congresses**

# Latin American

## International Congress on Natural and Applied Sciences -IV

March 13-15, 2023 / Rio de Janeiro, Brazil

# CONFERENCE PROGRAM

Online (with Video Conference) Presentation



**Meeting ID: 831 6051 5611**  
**Passcode: 131415**

---

### **IMPORTANT, PLEASE READ CAREFULLY**

- ❖ To be able to attend a meeting online, login via <https://zoom.us/join> site, enter ID "Meeting ID or Personal Link Name" and solidify the session.
- ❖ The Zoom application is free and no need to create an account.
- ❖ The Zoom application can be used without registration.
- ❖ The application works on tablets, phones and PCs.
- ❖ The participant must be connected to the session 5 minutes before the presentation time.
- ❖ All congress participants can connect live and listen to all sessions.
- ❖ Moderator is responsible for the presentation and scientific discussion (question-answer) section of the session.

### **Points to Take into Consideration - TECHNICAL INFORMATION**

- ◆ Make sure your computer has a microphone and is working.
- ◆ You should be able to use screen sharing feature in Zoom.
- ◆ Attendance certificates will be sent to you as pdf at the end of the congress.
- ◆ Requests such as change of place and time will not be taken into consideration in the congress program.

**Before you login to Zoom please indicate your name surname and hall number, exp. H-1, Fatih SAYIN**



# Latin American Scientific Research Congresses

## -Opening Ceremony-

13.03.2023

RIO DE JANEIRO LOCAL TIME - 10<sup>00</sup> : 10<sup>30</sup>

MEXICO LOCAL TIME - 07<sup>00</sup> : 07<sup>30</sup>

ANKARA LOCAL TIME - 16<sup>00</sup> : 16<sup>30</sup>

### **Dr. Mustafa Latif Emek**

President of IKSAD Institute, Türkiye

### **Dra. Felipa Sánchez Pérez**

Universidad Juárez Autónoma de Tabasco, México  
CHAIRMAN OF THE CONFERENCE

### **Dr. Germán Martínez Prats**

Universidad Juárez Autónoma de Tabasco, México

### **Dra. Francisca Silva Hernandez**

Universidad Juárez Autónoma de Tabasco, México

### **Dr. Rafael Renteria Ramos**Universidad

Nacional Abierta y a Distancia, Colombia

---

---





# Latin American Scientific Research Congresses

## ONLINE PRESENTATIONS

13.03.2023 / Hall-6, Session-1



RIO DE JANEIRO LOCAL TIME

08<sup>00</sup> : 10<sup>00</sup>



ANKARA LOCAL TIME

14<sup>00</sup> : 16<sup>00</sup>

### HEAD OF SESSION: Prof. Dr. Salah BELAIDI

G.P. Ashwinkumar C. Sulochana N.Sandeep	Vijayanagara Sri Krishnadevaraya University Gulbarga University Central University of Karnataka India	NUMERICAL INVESTIGATION OF CHEMICALLY REACTING MHD FLOW DUE TO A ROTATING CONE WITH THERMOPHORESIS AND BROWNIAN MOTION
Hamza Assila Younes Zaoui Issam Ameziane El hassani Abderrazzak El Moutaouakil Ala Allah Youssef Ramli M'Hammed Ansar	Mohammed V University in Rabat Morocco	SYNTHESIS OF ETHYL 2-(4-BENZYL-3- METHYL-6-OXO-1,6- DIHYDROPYRIDAZIN-1-YL)ACETATE : CRYSTAL STRUCTURE AND HIRSHFELD SURFACE ANALYSIS
Chennai Yasmine Belaidi Salah	University of Biskra	QSAR MODELING USING GAUSSIAN PROCESS APPLIED FOR A SERIES OF FLAVONOIDS AS POTENTIAL ANTIOXIDANTS
Chennai Yasmine Ouassaf Mebarka	University of Biskra	QUANTITATIVE STRUCTURE ACTIVITY RELATIONSHIP (QSAR) INVESTIGATIONS AND MOLECULAR DOCKING ANALYSIS OF PLASMODIUM PROTEIN FARNESYLTRANSFERASE INHIBITORS AS POTENT ANTIMALARIAL AGENTS
Dr.Yasmine CHENNAI Dr.Assma FETTEH	Mohamed Khaidhar University	ANTIBACTERIAL AND ANTI- OXIDANT ACTIVITIES OF EXTRACTS FROM MEDICINAL PLANTS
Prof. Dr. Salah BELAIDI Dr.Yasmine CHENNAI	Mohamed Khaidhar University	IN SILICO INVESTIGATION OF SEVERAL SERIES OF HETEROCYCLIC MOLECULES FOR DRUG DISCOVERY
Chennai Yasmine Ouassaf Mebarka	University of Biskra	CONTRIBUTION TO DRUG DISCOVERY THROUGH COMPUTATIONAL ANALYSIS OF SEVERAL SERIES OF HETEROCYCLIC MOLECULES



# Latin American Scientific Research Congresses

## ONLINE PRESENTATIONS

13.03.2023 / Hall-6, Session-2



RIO DE JANEIRO LOCAL TIME

10<sup>30</sup> : 12<sup>30</sup>



ANKARA LOCAL TIME

16<sup>30</sup> : 18<sup>30</sup>

### HEAD OF SESSION: Prof. Dr. Huma Ali

Rima SAADBOUZID Radhia BOUZIDI Imane SARHANI Donia HELLAL Leilia OUMDDOUR Massouda IBRIR Hachani KHADRAOUI Ghania BELAALOU	Batna 2 University Batna	BREAST CANCER; PRELIMINARY RESULTS OF A RETROSPECTIVE STUDY IN EASTERN ALGERIA
Eman Bunyan Ibrahim Rana Adil Hanoon	University of Duhok Iraq	DETECTION OF THE MUTATIONS ASSOCIATED WITH HEMOPHILIA A AND B IN DUHOK PROVINCE
Sidra Mohiuddin Soofi Dr. Afshan Siddiq	University of Karachi Pakistan	MORUS ALBA; A RAY OF HOPE FOR MENTAL ILLNESSES
Yusuf Rabe Yusuf Muhammad Sanyinna Abdulhamid Ahmed	Nigerian Defence Academy Nigerian Army University Biu Umaru Musa Yar'adua University	MOSQUITO VECTOR ABUNDANCE AND DISTRIBUTION ASSOCIATED WITH THE PREVALENCE OF MALARIA IN ZANGO LOCAL GOVERNMENT AREA, KATSINA STATE, NIGERIA
Prof. Dr. Huma Ali Dr. Saba Zubair	Jinnah Sindh Medical University	TRENDS AND ROLE OF PHARMACIST IN COMMUNITY PHARMACY SERVICES AND FACILITATION PROTOCOL: CHALLENGES IN REAL TIME PRACTICES
Özgür Ülkü ÖZDEMİR Şeyda BERK	Sivas Cumhuriyet University Türkiye	GLUCOSE TRANSPORTERS IN CANCER METABOLISM
Rabia KALELİ Şeyda BERK	Sivas Cumhuriyet University Türkiye	THE MOLECULAR MECHANISM OF CANCER METASTASIS
Istemi SERIN	University of Health Sciences Türkiye	LYMPHOCYTE LEVEL AT DIAGNOSIS IN HODGKIN LYMPHOMA: COULD IT BE AN INDICATOR OF THE STAGE AT INITIAL DIAGNOSIS?
P.H. Najafgulieva R.Sh.Qasimov	Azerbaijan Medical University	COMPARATIVE ANALYSIS OF NEW OPPORTUNITES FOR PHARMACOTHERAPY OF NON-SPECIFIC ULCERATIVE COLITS AND WAYS TO IMPROVE ITS PERFORMANCE EVALUATION



# Latin American Scientific Research Congresses

## ONLINE PRESENTATIONS

14.03.2023 / Hall-4, Session-1



RIO DE JANEIRO LOCAL TIME

08<sup>00</sup> : 10<sup>00</sup>



ANKARA LOCAL TIME

14<sup>00</sup> : 16<sup>00</sup>

### HEAD OF SESSION: Dr. Syed Makhdoom Hussain

Lyudmila Kabaivanova Lilyana Nacheva Venelin Hubenov Juliana Ivanova	Bulgarian Academy of Sciences Bulgaria	BIOACTIVE PRODUCTS FROM RED MICROALGAE GROWN IN DIGESTATE
Dr. Syed Makhdoom Hussain	Government College University pakistan	USE OF OILSEEDS BY-PRODUCTS IN AQUA-FEEDS
Aminu Ado Kaugama Mahrazu A. Yusuf Phd Ushie Onumashi Afi Phd Yusha'u Safiyanu Muhammad Ansar Bilyamin Adam Jabir Abdullahi Muhammad	Federal University Wukari Bayaro University Kano Chemistry Kano University	IMPACT OF HEAVY METALS CONTENT FOUND IN IRRIGATED RED PEPPER IN CHALLAWA INDUSTRIAL AREA
M. Mileva N. Vilhelmova-Ilieva G. Jovchev S. Gateva Tz. Gerasimova A. Dobрева	Bulgarian Academy of Sciences Bulgaria	BENEFICIAL BIOLOGICAL AND MEDICINAL EFFECTS OF THE BULGARIAN OIL-BEARING ROSE
Jyoti Sinha Vinod Kumar	Sushant University	PREPARATION AND EVALUATION OF TOPICAL PREPARATION OF EULALIOPSIS BINATA EXTRACT
Kave Koorehpaz	Urmia University	NOVEL CRYOPROTECTANTS AND THEIR EFFECTS ON DECREASING GLYCEROL CONCENTRATION DURING CRYOPRESEVVATION
Novotorzhina Nelya Rzayeva Irada Kazimzadeh Shafa Safarova Mehpara Gahramanova Gariba Mustafayeva Yegana	Institute of Additive Chemistry	HYDROXYMETHYL-P- TOLUENESULFONAMIDE AS AN ANTIOXIDANT ADDITIVE TO DIESEL FUELS



# Latin American Scientific Research Congresses

## ONLINE PRESENTATIONS

14.03.2023 / Hall-5, Session-1



RIO DE JANEIRO LOCAL TIME

08<sup>00</sup> : 10<sup>00</sup>



ANKARA LOCAL TIME

14<sup>00</sup> : 16<sup>00</sup>

### HEAD OF SESSION: Nebi BİLİR

Allahverdiyev Elxan Rəcəf oğlu Abbasova Nahide Şavaat qızı	Azərbaycan Dövlət Aqrar Universiteti Azərbaycan	DETERMINATION OF THE INFLUENCE OF STRUCTURE, SIZE OF WORKING NESTS AND THEIR FORAGING ON THE DEVELOPMENT OF FIELD MOUSE IN SOWN AREAS
Nilüfer YAZICI Nebi BİLİR	Isparta University Türkiye	GROWTH VARIATION IN FOREST TREE SPECIES IN AFFORESTATION OF GRADONI TERRACING
Nilüfer YAZICI Nebi BİLİR	Isparta University Türkiye	EFFECT OF TERRACING ON GROWTH OF TAURUS CEDAR (CEDRUS LIBANI): A CASE STUDY FROM ISPARTA DISTRICT
Oktay TOMAR Alptekin Mert YILMAZ	Kocaeli University Türkiye	FOOD WASTE AND FOOD LOSS: CAUSES, EFFECTS AND SOLUTIONS
Alptekin Mert YILMAZ Abdullah ÇAĞLAR Oktay TOMAR	Kocaeli University Türkiye	UPCYCLING IN THE AGRICULTURE AND FOOD SECTOR
Serim Tuna KOÇ	Trakya University Türkiye	ARONIA AND ANTHOCYANINS
Selen Tekin Ayşe Çiçek Korkmaz	Bandırma Onyeddi Eylül University Türkiye	HOLISTIC ANALYSIS OF NURSING COMPETENCE OF NURSES



# Latin American Scientific Research Congresses

## ONLINE PRESENTATIONS

14.03.2023 / Hall-6, Session-1



RIO DE JANEIRO LOCAL TIME

08<sup>00</sup> : 10<sup>00</sup>



ANKARA LOCAL TIME

14<sup>00</sup> : 16<sup>00</sup>

### HEAD OF SESSION: Prof. Zviad Kovziridze

Prof. Zviad Kovziridze Prof. Natela Nizharadze Assoc. Gulnazi Tabatadze Dr. Vera Kinkladze Dr. Nino Darakhvelidze Dr. Maia Balakhashvili	Georgian Technical University Georgia	OBTAINING AND STUDYING OF A HIGHLY REFRACTORY COMPOSITE BASED ON SiC BY HOT PRESSING
Prof. Dr. Qassim Shamkhi al khafaji Prof. Dr. Shaymaa Awad Kadhim Noor Ali jaafar Hasanain Alawadi PhD. Ihab Alfadhel	University of Kufa	EVALUATION OF ATOMIC PROPERTIES FOR Li-LIKE IONS SYSTEMS USING HARTREE- FOCK AND CONFIGURATION INTERACTION METHODS
Vekil SARI	Sivas Cumhuriyet University Türkiye	DESIGN AND MODEL OF AN INDUCTIVE WIRELESS POWER TRANSFER SYSTEM FOR ELECTRIC VEHICLES
Fatma MEYDANERİ TEZEL	Karabük University Türkiye	ELECTRICAL AND STRUCTURAL CHARACTERIZATION OF PBS THIN FILMS PRODUCED BY SPRAY METHOD
Fatma MEYDANERİ TEZEL NECMİ SERKAN TEZEL	Karabük University Türkiye	PbS SUPERCAPACITOR ELECTRODE STRUCTURES
Kahraman KÜÇÜK Fatih Mehmet BOTSALI	Türk Traktör ve Ziraat Makineleri A.Ş. Konya Technical University	EXPERIMENTAL INVESTIGATION OF THE EFFECT OF DIFFERENT DIAMETER CYLINDER USED IN HYDRO-PNEUMATIC SUSPENSION SYSTEM ON THE STRUCTURE
Fikret SÖNMEZ	Manisa Celal Bayar University Türkiye	ANALYSIS OF TOOL WEAR AND SURFACE ROUGHNESS VALUES IN THE MACHINING OF STAINLESS STEEL MATERIALS
Abdullah ERDEMİR Mete KALYONCU	MPG Machinery Production Group Inc. Co., Konya Technical University	MODELING IMPEDANCE CONTROL WITH LIMITED INTERACTION POWER FOR A 2R PLANAR ROBOT ARM
Melih Yazıcı	Bursa Technical University Türkiye	DEVELOPMENT OF FLAME RETARDANT PA6 AND PA66 COMPOSITES ACCORDING TO RAILWAYS EN 45545-2 STANDARD
C. BAKİ B. ÇETİN B. SAFRAN C. TANCI C. BAKRAÇ	Vector BTC Ltd. Şti Türkiye FNSS Defense Systems Inc. Türkiye Tura Design and Engineering Ltd. Şti Türkiye	FINITE ELEMENT ANALYSIS BASED DEFORMATION ANALYSIS OF A SPECIFIC UNI-AXIAL COMPRESSION TEST SET-TO FOR DETERMINATION OF CIRCLIP LIMIT FORCE



# Latin American Scientific Research Congresses

## ONLINE PRESENTATIONS

14.03.2023 / Hall-7, Session-1



RIO DE JANEIRO LOCAL TIME

08<sup>00</sup> : 10<sup>00</sup>



ANKARA LOCAL TIME

14<sup>00</sup> : 16<sup>00</sup>

### HEAD OF SESSION: Cüneyd YAVAŞ

Sadriddinova Dilobar Husniddin qizi	Bukhara State University Uzbekistan	THE IMPORTANCE OF PHYSICAL ACTIVITY IN IMPROVING PUBLIC HEALTH
Aigul Myrzabayeva	Al-Farabi Kazakh National University	ROLE OF APOPTOSIS AND PROLIFERATION OF VASCULAR WALL CELLS IN ATHEROGENESIS
Oya GÜVEN Dilek VURAL KELEŞ	Kırklareli University Türkiye	THE RELATIONSHIP OF NEUTROPHIL- LYMPHOCYTE RATIO AND PROGNOSIS IN COVID-19 PATIENTS
Nurşin AYDIN	Dicle University Türkiye	MATERNAL IMMUNITY TOLERANCE
Cüneyd YAVAŞ Savaş BARIŞ	Başakşehir Çam and Sakura City Hospital Türkiye Aydın Gynecology and Pediatrics Hospital Türkiye	A RARE CASE OF NOVEL MUTATION IN THE KIFBP GENE
Dilara ÜLGER ÖZBEK	Sivas Cumhuriyet University Türkiye	USAGE OF ICP-MS IN BIOLOGICAL SAMPLES
Süleyman Görgüç Cemilenur Atas Kübra Yıldırım Ece Şimsek Ahmet Yılmaz Çoban	Akdeniz University	INVESTIGATION OF THE BLOOD MICROBIOME PROFILE
Cemilenur Atas Majda Ličina Kübra Yıldırım Ece Şimsek Ahmet Yılmaz Çoban	Akdeniz University	IN VITRO CULTURE MODELS IN LATENT TUBERCULOSIS INFECTION





# Latin American Scientific Research Congresses

## ONLINE PRESENTATIONS

14.03.2023 / Hall-4, Session-2



RIO DE JANEIRO LOCAL TIME

10<sup>30</sup> : 12<sup>30</sup>



ANKARA LOCAL TIME

16<sup>30</sup> : 18<sup>30</sup>

### HEAD OF SESSION: Dr. German Martínez Prats, Dr. Francisca Silvia Hernández, Dr. Elizabeth García Moreno

Oliva Atiaga Fernanda Guerrero Fernando Páez Rafael Castro Edison Collahuazo Luís Miguel Nunes Marcelo Grijalva ván Grijalva Xosé Luis Otero	Universidad de las Fuerzas Armadas ESPE Universidade Compostela Universidade do Algarve Universidade de Lisboa University of Compostela	VARIATION OF AIR QUALITY DUE TO CONFINEMENT BY COVID-19 IN CITIES OF ECUADOR WITH THE USE OF SATELLITE DATA
Seyfi ŞEVİK	Hitit University	INVESTIGATION OF THE USABILITY OF THE HIGHWAY SURFACE DRAINAGE SYSTEM AS A PRECIPITATION WATER HARVESTING SYSTEM
K. Ömer TAŞ Günay BEYHAN H. Haluk SELİM	Sakarya University Türkiye National Defence University Türkiye	GEOMORPHOLOGIC ANALYSIS OF THE YENİŞEHİR (BURSA) BASIN
Duygu TAŞKIN Günay BEYHAN	Sakarya University Türkiye	PALEOSEISMIC STUDIES ON THE NORTH ANATOLIAN FAULT AND THE EAST ANATOLIAN FAULT AND EVALUATION OF ACTIVE FAULTS
Özlem ÖZKAN ÖNÜR	Düzce University Türkiye	STURCTURE TECHNIQUES USED IN EXAMPLES OF TRADITIONAL WOOD CIVIL ARCHITECTURE: TARAKLI HOUSES
Özlem ÖZKAN ÖNÜR	Düzce University Türkiye	IN HISTORICAL BUILDINGS DAMAGE CAUSITIVE STRUCTURE PHYSICS FACTORS
Res. Assist. Dr. Ceren AĞIN GÖZÜKIZIL Dr. Senem TEZCAN	Muş Alparslan University Türkiye The Istanbul Metropolitan Municipality	SATELLITE MUSEUMS AND ITS IMPACT ON URBAN SPACE
Johan Josueph Velazquez Martinez Dr. German Martínez Prats Dr. Francisca Silvia Hernández Dr. Elizabeth García Moreno	Universidad Juárez Autónoma de Tabasco	LA CONDENSACIÓN DE LA HUMEDAD ATMOSFÉRICA
Johan Josueph Velazquez Martinez Dr. German Martínez Prats Dr. Francisca Silvia Hernández Dr. Elizabeth García Moreno	Universidad Juárez Autónoma de Tabasco	PRODUCCIÓN DE AGUA POTABLE PARA RIEGO Y CONSUMO HUMANO



# Latin American Scientific Research Congresses

## ONLINE PRESENTATIONS

14.03.2023 / Hall-5, Session-2



RIO DE JANEIRO LOCAL TIME

10<sup>30</sup> : 12<sup>30</sup>



ANKARA LOCAL TIME

16<sup>30</sup> : 18<sup>30</sup>

### HEAD OF SESSION: Asst. Prof. Dr. İsa AVCI

Asst. Prof. Dr. Murat KOCA Asst. Prof. Dr. İsa AVCI	Van Yuzuncu Yil University Karabük University	SECURITY VULNERABILITIES IN CLOUD TECHNOLOGY
PUSHKAR PANDEY	Indian Institute of Technology	APPLYING UX PRINCIPLES TO FIND PRE-PATTERNS IN HANDHELD AUGMENTED REALITY GAMES
Marilda de los Angeles Carvalho Marquez Yazmin Isolda Álvarez García	Universidad Juárez Autónoma de Tabasco	COMERCIO ELECTRONICO
Aniekam Essienubong Ikpe Michael Okon Bassey Etuk Ekom Mike	Akwa Ibom State Polytechnic University of Benin	MULTIAXIAL NON-PROPORTIONAL RANDOM ANALYSIS OF A TYPICAL HUB STEERING KNUCKLE WITH RESPECT TO IN-SERVICE LOADING EFFECTS ON ITS GEOMETRIC MODEL
Abir Bounaama	-	EXISTENCE OF SOLUTIONS FOR QUASI-LINEAR HYPERBOLIC WEIGHTED EQUATION WITH SOURCE TERMS
Feyza ALTUNBEY ÖZBAY Erdal ÖZBAY	Firat University Türkiye	PERFORMANCE ANALYSIS OF SWARM-BASED METAHEURISTIC ALGORITHMS ON CONTINUOUS OPTIMIZATION PROBLEMS
Assist. Prof. Ayfer TEKİN ATACAN Emre Can BAYKURT	Yildiz Technical University Türkiye	NONLINEAR BEHAVIOR OF CIRCULAR SHALLOW ARCHES



# Latin American Scientific Research Congresses

## ONLINE PRESENTATIONS

14.03.2023 / Hall-6, Session-2



RIO DE JANEIRO LOCAL TIME

10<sup>30</sup> : 12<sup>30</sup>



ANKARA LOCAL TIME

16<sup>30</sup> : 18<sup>30</sup>

### HEAD OF SESSION: Dr. Ivan PAVLOVIC

Muhammad Adnan Arshad Asif Iqbal Umair Gull Muhammad Abdullah Saleem Saira Jamil Abid Shehzad	University of Agriculture Faisalabad	YIELD RESPONSES OF WHEAT (TRITICUM AESTIVUM L.) TO EXOGENOUS APPLIED MORINGA LEAF EXTRACT (MLE)
Bisma Yaseen Asif Iqbal Umair Gull Muhammad Abdullah Saleem Saira Jamil Abid Shehzad	University of Agriculture Faisalabad	EFFECT OF DIFFERENT SEEDING RATE AND HARVESTING INTERVAL ON THE FORAGE YIELD AND QUALITY OF MAIZE
Dr. Milena Milojević PhD student Suzana Knežević Dr. Biljana Delić Vujanović Dr. Goran Stanišić	Unit of Agricultural and Business	MILK PRODUCTION IN ACCORDANCE WITH THE PRINCIPLES OF SUSTAINABLE DEVELOPMENT: THE CASE OF FARM "KOJIC"
Dr. R. Saravanan	Bharath Institute of Higher Education and Research	PRODUCTION OF TRANSGENIC EDIBLE BANANA PLANT CONTAIN CT B GENE
Dr. Ivan PAVLOVIC	Scientific Institute of Veterinary Medicine of Serbia	BIODIVERSITY AND SEASONAL DISTRIBUTION OF CULICOIDES SPP. IN NORTH PART OF SERBIA (VOJVODINA)
Shoaib Alam Pharm.D	University Of Karachi	SCREENING OF PHASEOLOURS VULGARIS LINN. FOR PHARMACOLOGICAL AND TOXICOLOGICAL EFFECTS
Salma ELAMIRI Soumia ABOUL-HROUZ Achraf CHAKIR Mohamed ZAHOUILY	Hassan II University - Casablanca, Morocco	APPLICATION OF NOVEL SLOW- CONTROLLED RELEASE FERTILIZER (SCRf): MONITORING THE RELEASE PROFILE OF NITROGEN, PHOSPHORUS AND POTASSIUM IN WATER AND SOIL



# Latin American Scientific Research Congresses

## ONLINE PRESENTATIONS

14.03.2023 / Hall-7, Session-2



RIO DE JANEIRO LOCAL TIME

10<sup>30</sup> : 12<sup>30</sup>



ANKARA LOCAL TIME

16<sup>30</sup> : 18<sup>30</sup>

### HEAD OF SESSION: Major Gheorghe GIURGIU

Major Gheorghe GIURGIU Prof. dr. Manole COJOCARU	Titu Maiorescu University	MICROBIOTA MODULATION AS THERAPEUTIC APPROACH IN THE NEUROPATHIC PAIN IN DOG WITH SPINAL CORD INJURY: IMPACT OF POLENOPLASMIN
Milivoje Urošević Milosava Matejević Milena Milojević Tsegmid Namsrajav	University of Novi Sad Mongolian University of life sciences	BASIC MORPHOMETRIC PARAMETERS OF THE ANTLERS OF THE GOLDEN TROPHY RED DEERS ( <i>Cervus elaphus</i> L.)
Muhammad Waris MAJEED Hafiz Qadeer AHMED	University of Agriculture Pakistan	PREPARATION AND EVALUATION OF NANOPARTICLES OF ZINC OXIDE COATED INTRAMAMMARY INFUSION FOR THE TREATMENT OF SUBCLINICAL BOVINE MASTITIS
Memiş Özdemir Zekrullah Motmain Kübra Ekinci Esranur Saygılı	Atatürk University Türkiye	A META-ANALYSIS OF THE ASSOCIATION BETWEEN PROLACTIN (PRL) GENE POLYMORPHISM WITH LACTATION MILK AND PROTEIN PRODUCTION TRAITS IN CATTLE
Memiş Özdemir Zekrullah Motmain Kübra Ekinci Esranur Saygılı	Atatürk University Türkiye	INVESTIGATION OF THE RELATIONSHIP BETWEEN KAPPA-CASEIN GENE POLYMORPHISM AND MILK PRODUCTION CHARACTERISTICS IN HOLSTEIN BREED CATTLE: META-ANALYSIS
Dr. Wafa Majeed Dr. Muhammad Saad Tariq	University of Agriculture	ROLE OF RUTIN IN ATTENUATION OF METABOLIC GLUCOSE AND INSULIN IMPAIRMENT
Rodolfo Reda Renzo Guarnieri Alessio Zanza Marco Seracchiani Dario Di Nardo Luca Testarelli	Sapienza University of Rome	PERI-IMPLANT MARGINAL BONE LOSS PROGRESSION AND A-MMP-8

# CONTENT

Author	Title	No
Johan Josueph Velazquez Martinez Dr. German Martinez Prats Dr. Francisca Silvia Hernández Dr. Elizabeth García Moreno	LA CONDENSACIÓN DE LA HUMEDAD ATMOSFÉRICA	1
Johan Josueph Velazquez Martinez Dr. German Martinez Prats Dr. Francisca Silvia Hernández Dr. Elizabeth García Moreno	PRODUCCIÓN DE AGUA POTABLE PARA RIEGO Y CONSUMO HUMANO	3
G.P. Ashwinkumar C. Sulochana N.Sandeep	NUMERICAL INVESTIGATION OF CHEMICALLY REACTING MHD FLOW DUE TO A ROTATING CONE WITH THERMOPHORESIS AND BROWNIAN MOTION	5
Chennai Yasmine Belaidi Salah	QSAR MODELING USING GAUSSIAN PROCESS APPLIED FOR A SERIES OF FLAVONOIDS AS POTENTIAL ANTIOXIDANTS	6
Chennai Yasmine Ouassaf Mebarka	QUANTITATIVE STRUCTURE ACTIVITY RELATIONSHIP (QSAR) INVESTIGATIONS AND MOLECULAR DOCKING ANALYSIS OF PLASMODIUM PROTEIN FARNESYLTRANSFERASE INHIBITORS AS POTENT ANTIMALARIAL AGENTS	7
Dr.Yasmine CHENNAI Dr.Assma FETTEH	ANTIBACTERIAL AND ANTI- OXIDANT ACTIVITIES OF EXTRACTS FROM	8
Prof.Dr. Salah BELAIDI Dr. Yasmine CHENNAI	IN SILICO INVESTIGATION OF SEVERAL SERIES OF HETEROCYCLIC MOLECULES FOR DRUG DISCOVERY	9
Chennai Yasmine Ouassaf Mebarka	CONTRIBUTION TO DRUG DISCOVERY THROUGH COMPUTATIONAL ANALYSIS OF SEVERAL SERIES OF HETEROCYCLIC MOLECULES	10
Rima SAADBOUZID Radhia BOUZIDI Imane SARHANI Donia HELLAL Leilia OUMDDOUR Massouda IBRIR Hachani KHADRAOUI Ghania BELAALOU	BREAST CANCER; PRELIMINARY RESULTS OF A RETROSPECTIVE STUDY IN EASTERN ALGERIA	11
Sidra Mohiuddin Soofi Dr. Afshan Siddiq	MORUS ALBA; A RAY OF HOPE FOR MENTAL ILLNESSES	13
Yusuf Rabe Yusuf Muhammad Sanyinna Abdulhamid Ahmed	MOSQUITO VECTOR ABUNDANCE AND DISTRIBUTION ASSOCIATED WITH THE PREVALENCE OF MALARIA IN ZANGO LOCAL GOVERNMENT AREA, KATSINA STATE, NIGERIA	14
Prof. Dr. Huma Ali Dr. Saba Zubair	TRENDS AND ROLE OF PHARMACIST IN COMMUNITY PHARMACY SERVICES AND FACILITATION PROTOCOL: CHALLENGES IN REAL TIME PRACTICES	15
Özgür Ülkü ÖZDEMİR Şeyda BERK	GLUCOSE TRANSPORTERS IN CANCER METABOLISM	16
Rabia KALELİ Şeyda BERK	THE MOLECULAR MECHANISM OF CANCER METASTASIS	28

Istemi SERIN	LYMPHOCYTE LEVEL AT DIAGNOSIS IN HODGKIN LYMPHOMA: COULD IT BE AN INDICATOR OF THE STAGE AT INITIAL DIAGNOSIS?	41
P.H. Najafgulieva R.Sh.Qasimov	COMPARATIVE ANALYSIS OF NEW OPPORTUNITES FOR PHARMACOTHERAPY OF NON-SPECIFIC	44
Dr. Syed Makhdoom Hussain	USE OF OILSEEDS BY-PRODUCTS IN AQUA-FEEDS	46
Aminu Ado Kaugama Mahrazu A. Yusuf Phd Ushie Onumashi Afi Phd Yusha'u Safiyanu Muhammad Ansar Bilyamin Adam Jabir Abdullahi Muhammad	IMPACT OF HEAVY METALS CONTENT FOUND IN IRRIGATED RED PEPPER IN CHALLAWA INDUSTRIAL AREA	47
Jyoti Sinha Vinod Kumar	PREPARATION AND EVALUATION OF TOPICAL PREPARATION OF EULALIOPSIS BINATA EXTRACT	48
Kave Koorehpaz	NOVEL CRYOPROTECTANTS AND THEIR EFFECTS ON DECREASING GLYCEROL CONCENTRATION DURING CRYOPRESEVVATION	49
Novotorzhina Nelya Rzayeva Irada Kazimzadeh Shafa Safarova Mehpara Gahramanova Gariba Mustafayeva Yegana	HYDROXYMETHYL-P-TOLUENESULFONAMIDE AS AN ANTIOXIDANT ADDITIVE TO DIESEL FUELS	50
Associate Professor Allakhverdiyev Elkhhan Rajaf D. student, Abbasova Nahida Shavaat	DETERMINATION OF THE INFLUENCE OF STRUCTURE, SIZE OF WORKING NESTS AND THEIR FORAGING ON THE DEVELOPMENT OF FIELD MOUSE IN SOWN AREAS	53
Nilüfer YAZICI Nebi BİLİR	GROWTH VARIATION IN FOREST TREE SPECIES IN AFFORESTATION OF GRADONI TERRACING	56
Nilüfer YAZICI Nebi BİLİR	EFFECT OF TERRACING ON GROWTH OF TAURUS CEDAR ( <i>CEDRUS LIBANI</i> ): A CASE STUDY FROM ISPARTA DISTRICT	58
Nilüfer YAZICI Nebi BİLİR	GROWTH VARIATION IN FOREST TREE SPECIES IN AFFORESTATION OF GRADONI TERRACING	65
Serim Tuna KOÇ	ARONIA AND ANTHOCYANINS	72
Prof.Dr.Qassim Shamkhi al khafaji Prof.Dr.shaymaa Awad Kadhim Noor Ali jaafar Hasanain Alawadi PhD.Ihab Alfadhel	EVALUTION OF ATOMIC PROPERTIES FOR LI-LIKE IONS SYSTEMS USING HARTREE-FOCK AND CONFIGURATION INTERACTION METHODS	74
Vekil SARI	DESIGN AND MODEL OF AN INDUCTIVE WIRELESS POWER TRANSFER SYSTEM FOR ELECTRIC VEHICLES	90
Fatma MEYDANERİ TEZEL	ELECTRICAL AND STRUCTURAL CHARACTERIZATION OF PBS THIN FILMS PRODUCED BY SPRAY METHOD	100
Prof. Dr., Fatma MEYDANERİ TEZEL Prof. Dr.NECMİ SERKAN TEZEL	PbS SUPERCAPACITOR ELECTRODE STRUCTURES	108
Kahraman KÜÇÜK Prof. Dr. Fatih Mehmet BOTSALI	EXPERIMENTAL INVESTIGATION OF THE EFFECT OF DIFFERENT DIAMETER CYLINDER USED IN HYDRO-PNEUMATIC SUSPENSION SYSTEM ON THE STRUCTURE	117
Fikret SÖNMEZ	ANALYSIS OF TOOL WEAR AND SURFACE ROUGHNESS VALUES IN THE MACHINING OF STAINLESS STEEL MATERIALS	119
Abdullah ERDEMİR Prof. Dr. Mete KALYONCU	MODELING IMPEDANCE CONTROL WITH LIMITED INTERACTION POWER FOR A 2R PLANAR ROBOT ARM	130



Melih Yazıcı	DEVELOPMENT OF FLAME RETARDANT PA6 AND PA66 COMPOSITES ACCORDING TO RAILWAYS EN 45545-2 STANDARD	143
C. BAKİ B. ÇETİN B. SAFRAN C. TANCI C. BAKRAÇ	FINITE ELEMENT ANALYSIS BASED DEFORMATION ANALYSIS OF A SPESIFIC UNI-AXIAL COMPRESSION TEST SET-TO FOR DETERMINATION OF CIRCLIP LIMIT FORCE	145
Sadriddinova Dilobar Husniddin qizi	THE IMPORTANCE OF PHYSICAL ACTIVITY IN IMPROVING PUBLIC HEALTH	146
Aigul Myrzabayeva	ROLE OF APOPTOSIS AND PROLIFERATION OF VASCULAR WALL CELLS IN ATHEROGENESIS	150
Oya GÜVEN Dilek VURAL KELEŞ	THE RELATIONSHIP OF NEUTROPHIL-LYMPHOCYTE RATIO AND PROGNOSIS IN COVID-19 PATIENTS	151
Doktorant Nurşin AYDIN	MATERNAL IMMUNITY TOLERANCE	159
Cüneyd YAVAŞ Savaş BARIŞ	A RARE CASE OF NOVEL MUTATION IN THE KIFBP GENE	166
Dilara ÜLGER ÖZBEK	USAGE OF ICP-MS IN BIOLOGICAL SAMPLES	168
Süleyman Görgüç Cemilenur Ataş Kübra Yıldırım Ece Şimsek Ahmet Yılmaz Çoban	INVESTIGATION OF THE BLOOD MICROBIOME PROFILE	176
Cemilenur Ataş Majda Ličina Kübra Yıldırım Ece Şimsek Ahmet Yılmaz Çoban	IN VITRO CULTURE MODELS IN LATENT TUBERCULOSIS INFECTION	189
Seyfi ŞEVİK	INVESTIGATION OF THE USABILITY OF THE HIGHWAY SURFACE DRAINAGE SYSTEM AS A PRECIPITATION WATER HARVESTING SYSTEM	198
Özlem ÖZKAN ÖNÜR	IN HISTORICAL BUILDINGS DAMAGE CAUSITIVE STRUCTURE PHYSICS FACTORS	212
Ceren AĞIN GÖZÜKIZIL Senem TEZCAN	SATELLITE MUSEUMS AND ITS IMPACT ON URBAN SPACE	226
Asst. Prof. Dr. Murat KOCA Asst. Prof. Dr. İsa AVCI	SECURITY VULNERABILITIES IN CLOUD TECHNOLOGY	228
PUSHKAR PANDEY	APPLYING UX PRINCIPLES TO FIND PRE-PATTERNS IN HANDHELD AUGMENTED REALITY GAMES	235
Aniekam Essienubong Ikpe Michael Okon Bassey Etuk Ekom Mike	MULTIAXIAL NON-PROPORTIONAL RANDOM ANALYSIS OF A TYPICAL HUB STEERING KNUCKLE WITH RESPECT TO IN-SERVICE LOADING EFFECTS ON ITS GEOMETRIC MODEL	236
Dr. Feyza ALTUNBEY ÖZBAY Dr. Erdal ÖZBAY	PERFORMANCE ANALYSIS OF SWARM-BASED METAHEURISTIC ALGORITHMS ON CONTINUOUS OPTIMIZATION PROBLEMS	250
Ayfer TEKİN ATACAN Emre Can BAYKURT	NONLINEAR BEHAVIOR OF CIRCULAR SHALLOW ARCHES	263
Muhammad Adnan Arshad Asif Iqbal Umair Gull Muhammad Abdullah Saleem Saira Jamil Abid Shehzad	YIELD RESPONSES OF WHEAT (TRITICUM AESTIVUM L.) TO EXOGENOUS APPLIED MORINGA LEAF EXTRACT (MLE)	265

Bisma Yaseen Asif Iqbal Umair Gull Muhammad Abdullah Saleem Saira Jamil Abid Shehzad	EFFECT OF DIFFERENT SEEDING RATE AND HARVESTING INTERVAL ON THE FORAGE YIELD AND QUALITY OF MAIZE ( <i>Zea mays</i> L.)	267
Dr. R. Saravanan	PRODUCTION OF TRANSGENIC EDIBLE BANANA PLANT CONTAIN CT B GENE	269
Academician., PrincipalRes.Fell., Dr. Ivan PAVLOVIC	BIODIVERSITY AND SEASONAL DISTRIBUTION OF CULICOIDES SPP.IN NORTH PART OF SERBIA (VOJVODINA)	270
Major Gheorghe GIURGIU Prof. dr. Manole COJOCARU	MICROBIOTA MODULATION AS THERAPEUTIC APPROACH IN THE NEUROPATHIC PAIN IN DOG WITH SPINAL CORD INJURY: IMPACT OF POLENOPLASMIN	271
Milivoje Urošević Milosava Matejević Milena Milojević Tsegmid Namsrajav	BASIC MORPHOMETRIC PARAMETERS OF THE ANTLERS OF THE GOLDEN TROPHY RED DEERS ( <i>Cervus elaphus</i> L.)	272
Muhammad Waris MAJEED Hafiz Qadeer AHMED	PREPARATION AND EVALUATION OF NANOPARTICLES OF ZINC OXIDE COATED INTRAMAMMARY INFUSION FOR THE TREATMENT OF SUBCLINICAL BOVINE MASTITIS	279
Memiş Özdemir Zekrullah Motmain Kübra Ekinci Esratur Saygılı	A META-ANALYSIS OF THE ASSOCIATION BETWEEN PROLACTIN (PRL) GENE POLYMORPHISM WITH LACTATION MILK YIELD AND PROTEIN PRODUCTION TRAITS IN CATTLE	281
Dr. Wafa Majeed Dr. Muhammad Saad Tariq	ROLE OF RUTIN IN ATTENUATION OF METABOLIC GLUCOSE AND INSULIN IMPAIRMENT	288
Rodolfo Reda Renzo Guarnieri Alessio Zanza Marco Seracchiani Dario Di Nardo Luca Testarelli	PERI-IMPLANT MARGINAL BONE LOSS PROGRESSION AND A-MMP-8 CAN BE CONSIDERED AS INDICATORS OF THE SUBSEQUENT ONSET OF PERI-IMPLANTITIS. A 5-YEAR STUDY	289
Özlem ÖZKAN ÖNÜR	STURUCTURE TECHNIQUES USED IN EXAMPLES OF TRADITIONAL WOOD CIVIL ARCHITECTURE: TARAKLI HOUSES	291
Selen Tekin Ayşe Çiçek Korkmaz	HOLISTIC ANALYSIS OF NURSING COMPETENCE OF NURSES	305
Dr. Milena Milojević PhD student Suzana Knežević Dr. Biljana Delić Vujanović Dr. Goran Stanišić	MILK PRODUCTION IN ACCORDANCE WITH THE PRINCIPLES OF SUSTAINABLE DEVELOPMENT: THE CASE OF FARM "KOJIĆ"	308
Ceren AĞIN GÖZÜKIZIL Senem TEZCAN	SATELLITE MUSEUMS AND ITS IMPACTS ON URBAN SPACE	309
K. Ömer TAŞ Günay BEYHAN H. Haluk SELİM	GEOMORPHOLOGIC ANALYSIS OF THE YENİŞEHİR (BURSA) BASİN	322
Oktay TOMAR Alptekin Mert YILMAZ	FOOD WASTE AND FOOD LOSS: CAUSES, EFFECTS AND SOLUTIONS	330
Alptekin Mert YILMAZ Abdullah ÇAĞLAR Oktay TOMAR	UPCYCLING IN THE AGRICULTURE AND FOOD SECTOR	342
Duygu TAŞKIN Günay BEYHAN	PALEOSEISMIC STUDIES ON THE NORTH ANATOLIAN FAULT AND THE EAST ANATOLIAN FAULT AND EVALUATION OF ACTIVE FAULTS	359

MemiŐ Ozdemir  
Zekrullah Motmain  
Kübra Ekinci  
Esratur Saygılı

INVESTIGATION OF THE RELATIONSHIP BETWEEN KAPPA-  
CASEIN GENE POLYMORPHISM AND MILK PRODUCTION  
CHARACTERISTICS IN HOLSTEIN BREED CATTLE: META-  
ANALYSIS

372

**4TH INTERNATIONAL LATIN AMERICAN  
CONGRESS ON NATURAL AND APPLIED SCIENCES**  
**LA CONDENSACIÓN DE LA HUMEDAD ATMOSFÉRICA**

**Johan Josueph Velazquez Martinez**

Universidad Juárez Autónoma de Tabasco

<https://orcid.org/0000-0001-8185-7214>

**Dr. German Martínez Prats**

Universidad Juárez Autónoma de Tabasco

<https://orcid.org/0000-0001-6371-448X>

**Dr. Francisca Silvia Hernández**

Universidad Juárez Autónoma de Tabasco

<https://orcid.org/0000-0003-3533-0002>

**Dr. Elizabeth García Moreno**

Universidad Juárez Autónoma de Tabasco, México

## **RESUMEN**

La falta de infraestructura hídrica genera una escasez económica de agua y no garantiza el acceso al agua. El tener más desarrollo de infraestructura hídrica alivia por mucho la escasez pero de igual manera se debe considerar los impactos del cambio climático, siendo importante tomar en cuenta que el agua sostiene los ecosistemas terrestres (pastizales, ríos, lagos, etc.) que al contar con la infraestructura y la aplicación correcta proporcionan servicios importantes como la purificación para consumo humano, suministro de agua, producción de alimentos y actividades económicas

Siempre es importante buscar soluciones eficientes que estos abastezcan el agua potable para todos los ciudadanos que carecen. Es por ello por lo que se crean innovadoras tecnologías para extraer el agua de la humedad del aire; Se considera es posible utilizar energías renovables como es la energía eólica, cubriendo y solucionando a un problema generalizado. Se considera que estas innovaciones permiten que el acceso al agua potable a muchas personas usando simplemente la energía eólica.

Estas innovaciones tienen la tendencia de mejorar por mucho la calidad de vida de las personas, permitiendo que haya producción de agua extrayéndola de la humedad del aire aplicando el proceso de condensación; considerándose que depende de una fuente de energía sencilla que se conoce desde hace miles de años.

Todos los proyectos cuentan con una gran relevancia, sistemas complejos y diferentes pero al mismo tiempo buscan resolver la problemática presentada desde mucho tiempo atrás y gracias a los avances tecnológicos y métodos es posible la generación de agua a partir de la condensación del aire, aun habiendo muchas alternativas en prototipos siempre está abierta la índole de afrontar las problemáticas de todo tipo y mejorarlas, principalmente en base a un

**4TH INTERNATIONAL LATIN AMERICAN  
CONGRESS ON NATURAL AND APPLIED SCIENCES**

desarrollo sostenible siempre y cuando contando con el diseño e implementaciones de nuevas tecnologías.

**ABSTRACT**

The lack of water infrastructure generates an economic shortage of water and does not guarantee access to water. Having more development of water infrastructure greatly alleviates scarcity but in the same way the impacts of climate change must be considered, being important to take into account that water sustains terrestrial ecosystems (grasslands, rivers, lakes, etc.) that by having the infrastructure and the correct application provide important services such as purification for human consumption, Water supply, food production and economic activities

It is always important to look for efficient solutions that supply drinking water for all citizens who lack. That is why innovative technologies are created to extract water from moisture in the air; It is considered possible to use renewable energies such as wind energy, covering and solving a widespread problem. These innovations are considered to allow access to drinking water to many people simply using wind energy.

These innovations have the tendency to greatly improve the quality of life of people, allowing water production by extracting it from the humidity of the air by applying the condensation process; considering that it depends on a simple energy source that has been known for thousands of years.

All projects have great relevance, complex and different systems but at the same time seek to solve the problem presented for a long time and thanks to technological advances and methods it is possible to generate water from air condensation, even if there are many alternatives in prototypes is always open the nature of facing problems of all kinds and improving them, mainly based on sustainable development as long as it has the design and implementation of new technologies.

**4TH INTERNATIONAL LATIN AMERICAN  
CONGRESS ON NATURAL AND APPLIED SCIENCES**

**PRODUCCIÓN DE AGUA POTABLE PARA RIEGO Y CONSUMO HUMANO**

**Johan Josueph Velazquez Martinez**

Universidad Juárez Autónoma de Tabasco

<https://orcid.org/0000-0001-8185-7214>

**Dr. German Martinez Prats**

Universidad Juárez Autónoma de Tabasco

<https://orcid.org/0000-0001-6371-448X>

**Dr. Francisca Silvia Hernández**

Universidad Juárez Autónoma de Tabasco

<https://orcid.org/0000-0003-3533-0002>

**Dr. Elizabeth García Moreno**

Universidad Juárez Autónoma de Tabasco, México

**RESUMEN**

El agua es esencial para la vida en la Tierra, es necesaria para la vida, la salud y el medio ambiente. Sin agua, la vida tal como la conocemos no existiría. El problema de la escasez de agua potable es una preocupación importante en muchas áreas del mundo. Varios países han producido agua potable a partir de recursos renovables durante siglos. Los países también recolectan agua de lluvia para complementar sus fuentes naturales de agua potable. Sin embargo, hay formas de recolectar agua potable de manera segura si es necesario.

Muchas personas en áreas rurales recolectan agua potable de fuentes contaminadas. El agua contaminada es cuando las sustancias nocivas contaminan la fuente recolectada. Algunas fuentes comunes de agua contaminada son los abrevaderos de animales y los pantanos. Esto se debe a la eliminación inadecuada de los desechos animales. El agua contaminada puede ser letal si no se trata. Sin embargo, hay formas de tratar el agua potable contaminada con cloro y



**4TH INTERNATIONAL LATIN AMERICAN  
CONGRESS ON NATURAL AND APPLIED SCIENCES**

otros productos químicos. Estas soluciones ayudan a prevenir enfermedades fatales causadas por bacterias en el agua contaminada. Incluso entonces, las fuentes de agua potable tratada y no contaminada cuestan dinero y requieren un mantenimiento continuo.

**ABSTRACT**

Water is essential for life on Earth, it is necessary for life, health and the environment. Without water, life as we know it would not exist. The problem of drinking water scarcity is a major concern in many areas of the world. Several countries have produced drinking water from renewable resources for centuries. Countries also collect rainwater to supplement their natural sources of drinking water. However, there are ways to collect drinking water safely if needed.

Many people in rural areas collect drinking water from contaminated sources. Contaminated water is when harmful substances contaminate the collected source. Some common sources of contaminated water are animal troughs and swamps. This is due to improper disposal of animal waste. Contaminated water can be lethal if left untreated. However, there are ways to treat drinking water contaminated with chlorine and other chemicals. These solutions help prevent fatal diseases caused by bacteria in contaminated water. Even then, sources of treated and uncontaminated drinking water cost money and require ongoing maintenance.

**4TH INTERNATIONAL LATIN AMERICAN  
CONGRESS ON NATURAL AND APPLIED SCIENCES**

**NUMERICAL INVESTIGATION OF CHEMICALLY REACTING MHD FLOW DUE  
TO A ROTATING CONE WITH THERMOPHORESIS AND BROWNIAN MOTION**

**G.P. Ashwinkumar**

Department of Mathematics, Vijayanagara Sri Krishnadevaraya University, Bellary-583105  
India.

**C. Sulochana**

Department of Mathematics, Gulbarga University, Kalaburagi-585106, India.

**N.Sandeep**

Department of Mathematics, Central University of Karnataka, Kalaburagi, India.

**ABSTRACT**

In this study we analysed the momentum, heat and mass transfer behaviour of magnetohydrodynamic flow towards a vertical rotating cone in porous medium with thermophoresis and Brownian motion effects. Further, the numerical solutions are elucidated by using Runge-Kutta based shooting technique. Obtained results are validated with open literature and found an excellent agreement. The influence of non-dimensional governing parameters on velocity, temperature and concentration profiles along with the friction factor, local Nusselt and Sherwood numbers are determined and discussed with the help of graphs and tables. Results proved that the thermophoresis and Brownian motion parameters have tendency to control the heat and mass transfer rates. It is also found that a raise in the porosity parameter develops the heat and mass transfer rate.

**Keywords:** MHD, Rotating cone, Thermophoresis, Brownian motion, Chemical reaction.

**4TH INTERNATIONAL LATIN AMERICAN  
CONGRESS ON NATURAL AND APPLIED SCIENCES**

**QSAR MODELING USING GAUSSIAN PROCESS APPLIED FOR A SERIES OF  
FLAVONOIDS AS POTENTIAL ANTIOXIDANTS**

**Chennai Yassmine**

**Belaidi Salah**

Group of Computational and Pharmaceutical Chemistry, LMCE Laboratory, University of  
Biskra, BP 145 Biskra 07000, Algeria

**ABSTRACT**

For decades, flavonoids have been the core of diverse research, especially for their significant antioxidant activity. They have several biological activities, and they are used as anticancer, antileishmanial, anti-inflammatory, and antiaging compounds. However, current researchers are very much interested in the antioxidant activity of flavonoids since oxidative stress is strongly related to several diseases. In this study, we have chosen to elaborate on a quantitative structure-antioxidant activity relationship (QSAR) using a statistical method called Gaussian process (GP). The main advantage of this method compared to other techniques currently used in QSAR studies is that it does not increase the complexity of learning tests. Typical QSAR studies use common techniques such as the artificial neural method, multiple linear regression, and partial least squares regression. The aim of this work was to use a statistical technique little known in pharmaceutical chemistry, the Gaussian process regression which is rarely used to build a QSAR model. Finally, we have also demonstrated that GP is reliable and capable of predicting the antioxidant activity with a respectable record ( $R^2_{pred}$ ) which is equal to 0.86, so it is much higher than the reference value of 0.6. Therefore, we estimate that this reliable model can be used to predict the antioxidant activity of a series of new molecules. Also, based on the HC results, our set was divided into four separate clusters according to the presence of glycosides and the molar weight of the flavonoids.

**Keywords:** Flavonoids, Antioxidant, QSAR, Gaussian process, PCA, HCA.

**4TH INTERNATIONAL LATIN AMERICAN  
CONGRESS ON NATURAL AND APPLIED SCIENCES**

**QUANTITATIVE STRUCTURE ACTIVITY RELATIONSHIP (QSAR)  
INVESTIGATIONS AND MOLECULAR DOCKING ANALYSIS OF PLASMODIUM  
PROTEIN FARNESYLTRANSFERASE INHIBITORS AS POTENT  
ANTIMALARIAL AGENTS.**

**Chennai Yasmine**

**Ouassaf Mebarka**

Group of Computational and Pharmaceutical Chemistry, LMCE Laboratory, University of  
Biskra, BP 145 Biskra 07000, Algeria

**ABSTRACT**

The development of farnesyltransferase inhibitors based on the benzophenone scaffold directed against Plasmodium falciparum is considered a strategy in malaria treatment. In this work, quantitative structure–activity relationship (**QSAR**) was performed to predict the protein farnesyltransferase (**PFT**) inhibitory activities for a series of 36 benzophenone derivatives. The data set was divided into two subsets of training and test sets, and the best model using **multiple linear regression (MLR)**, with the values of internal and external validity ( $R^2 = 0.884$ ,  $R^2_{adj} = 0.865$ ,  $R^2_{pred} = 0.821$ ,  $Q^2_{cv} = 0.822$  and  $R^2_p = 0.811$ ) was found in agreement with the Tropsha and Golbraikh criteria. The applicability domain (AD) was determined using the Williams plot to describe the chemical space for the model used in this study. The model shows that antimalarial activities of benzophenone depend on logP, bpol, MAXDn, and FMF descriptors. These indications prompted us to design new benzophenones PFT inhibitors and predict the value of their anti-malarial activities based on the MLR equation. Docking results reveal that the newly designed benzophenones bind to the hydrophobic pocket and polar contact with high affinity. The predicted results from this study can help to design novel benzophenone as inhibitors of human **PFT** with high antimalarial activities.

**KeyWord :** QSAR, docking, benzophenone, PFT inhibitory, antimalarial.

**4TH INTERNATIONAL LATIN AMERICAN  
CONGRESS ON NATURAL AND APPLIED SCIENCES**

**ANTIBACTERIAL AND ANTI- OXIDANT ACTIVITIES OF EXTRACTS FROM  
medicinal plants**

**Dr.Yassmine CHENNAI**

Mohamed Khaidhar University, Biskra

**Dr.Assma FETTEH**

Mohamed Khaidhar University, Biskra

**ABSTRACT**

The algerian flora provides a diverse range of aromatic plants with a high therapeutic interest due to their secondary biologically active metabolites, which have sparked scientific interest. In this study, we are interested in the plants *Ocimum basilicum* L. of the Lamiaceae family and *Artemisia campestris* A. of the Asteriaceae family, which are well known locally and have a variety of curative properties in traditional medicine. The first part of this study is devoted to the quality control of the plant powder and the investigation of the metabolites. The phytochemical screening revealed the presence of flavonoids, tannins, coumarine, essential oil, and other metabolic compounds. The HE were obtained using hydrodistillation with a yield of 2.4% for *O.basilicum* L. and 1.8% for *A.campestris* A. The phenolic compounds were obtained by a series of extractions with four solvents of increasing polarity. The concentration of these extracts in total polyphénols, flavonoids, and tanins was determined by using the reactif Folin Ciocalteu, aluminum trichlorure, and vanilline with the addition of chlorhydric acid. In the second section, we investigated the antioxidative capacity of extracts (HE and phenolic compounds) in vitro using the DPPH method. The results show that our extracts have interesting antioxidant properties, with ethyl acetate being the most effective. Furthermore, the essential oil has a very low antioxidative activity when compared to the benchmark for the two plants. Finally, we assessed the antibacterial activity of our extracts against ten pathogenic bacteria using the MH diffusion method. The results show that phenolic extracts of *O.basilicum* L. have higher activity for HE. Unlike *A.campestris* A., the acétate of éthyle extract is the most active on the majority of Gram+ souches.

**Keywords:** *O.basilicum* L., *Artemisia campestris* A, Antibacterial, oxidant activities

**4TH INTERNATIONAL LATIN AMERICAN  
CONGRESS ON NATURAL AND APPLIED SCIENCES**

**IN SILICO INVESTIGATION OF SEVERAL SERIES OF HETEROCYCLIC  
MOLECULES FOR DRUG DISCOVERY**

**Prof.Dr. Salah BELAIDI**

Mohamed Khaidhar University, Biskra

**Dr.Yassmine CHENNAI**

Mohamed Khaidhar University, Biskra

**ABSTRACT**

Drug discovery and design are inextricably linked to various branches of chemistry, particularly organic chemistry. Many aspects of chemistry must be involved in order to translate knowledge of the molecular, genetic, and cellular bases of cancer into effective therapies. Thus, the goal of this research is to identify promising active compounds for coumarin as CK2 protein kinase inhibitors using a QSAR model and drug similarity analysis. CK2 is a ubiquitous Ser/Thr-specific protein kinase that is required for cell cycle viability and progression. CK2 levels are particularly high in proliferating, normal, or transformed tissues, and transgenic mice expressing its catalytic subunit are responsible for lymphomas. The work began with the optimization of the equilibrium structures of the basic coumarin in order to select the most reliable forecasting approach compared to experimentation and at the lowest computational cost. Following our research, we conduct a multiple linear regression (MLR) analysis to generate QSAR models. An external validation research was done because the results show that the QSAR model of CK2 inhibitory activity is robust and has extremely strong prediction capacity, as indicated by R<sup>2</sup> values of 0.951 and 0.927, respectively, following linear regression analysis. The investigation using QSAR models is successful in screening 34 candidate chemicals. Following that, the compounds under consideration were evaluated for drug-likeness and reactivity (ADME, golden triangle, lipophylicity indices). The results reveal that when supplied orally, the majority of the substances have no bioavailability issues.

The data also aid in determining which chemicals do not have clearance issues, as well as which are the most stable and reactive among those examined. The anticipated findings of this study may aid in the development of novel coumarins with significant CK2 inhibitor activity.

**Keywords:** coumarine, CK2, QSAR, MLR.



**4TH INTERNATIONAL LATIN AMERICAN  
CONGRESS ON NATURAL AND APPLIED SCIENCES**

**CONTRIBUTION TO DRUG DISCOVERY THROUGH  
COMPUTATIONAL ANALYSIS OF SEVERAL SERIES OF HETEROCYCLIC  
MOLECULES**

**Chennai Yassmine**

**Ouassaf Mebarka**

Group of Computational and Pharmaceutical Chemistry, LMCE Laboratory, University of  
Biskra, BP 145 Biskra 07000, Algeria

**ABSTRACT**

Breast cancer is the most common type of female cancer. One class of hormonal therapy for breast cancer drugs -non steroidal aromatase inhibitors- are triazole analogues. In this work a fundamental and original research was made on the molecule of triazole heterocyclic, whose the aim is to predict the reactivity and biological activity studied of the compound. It is based on different computational and approaches used in computer aided -drug-design. (SPR, QSAR, molecular docking, ADMET). A study of structure – property relationships (SPR) for 1,2,3 triazole derivatives has been carried. A linear quantitative structure activity relationship model is obtained using Multiple Linear Regression (MLR) analysis as applied to a series of triazole derivatives with inhibitory activity of the aromatase. The accuracy of the proposed MLR model is illustrated using the following evaluation techniques: cross validation, and external test. Docking process, the interaction and binding of ligands – protein were done and visualized using software Molegro Virtual Docking. Molinspiration and ADMETSAR web servers used to calculate ADMET and physicochemical properties of the target compounds respectively. The results are reported and discussed in the present investigation. A close agreement with experimental results was found which improves the affinity of the present work.

**KeyWord:** 1,2,3-triazole, aromatase inhibitory, density functional theory, QSAR, MLR, ADMET, docking molecular

**4TH INTERNATIONAL LATIN AMERICAN  
CONGRESS ON NATURAL AND APPLIED SCIENCES**

**BREAST CANCER; PRELIMINARY RESULTS OF A RETROSPECTIVE STUDY IN  
EASTERN ALGERIA**

**Rima SAADBOUZID**

Laboratory of Acquired and Constitutional Genetic Diseases (MAGECA), Department of  
Medicine, Faculty of Medicine, Batna 2 University, Ezzouhour, Batna 05000, Algeria  
<https://orcid.org/0000-0001-8870-3365>

**Radhia BOUZIDI**

Faculty of Nature and Life Sciences, Batna 2 University, Batna, Algeria

**Imane SARHANI**

Faculty of Medicine, Batna 2 University, Batna, Algeria

**Donia HELLAL**

Physicien, Anatomopathology Department CLCC Batna

**Leilia OUMDDOUR**

Chief Physicien, Anatomopathology Department CLCC Batna

**Massouda IBRIR**

Faculty of Medicine, Batna 2 University, Batna, Algeria

**Hachani KHADRAOUI**

Faculty of Medicine, Batna 2 University, Batna, Algeria

**Ghania BELAALOU**

Faculty of Medicine, Batna 2 University, Batna, Algeria

**ABSTRACT**

Breast cancer is the most frequently diagnosed cancer and the second cause of death worldwide and in Algeria. We can distinguish different histological and molecular entities in breast cancer. The objective of this work is to report the preliminary results of a molecular and histological characterization of breast cancer in CLCC Batna center during the period from 2018 to 2022.

Clinical and pathological characteristics of 570 breast cancer cases were collected from the archives of the pathology department of CLCC and CHU hospital Batna. To analyze their characteristics, age, histological type, SBR grade, hormone receptor status, HER2 status were taken in account, and molecular phenotypes were compared.

**4TH INTERNATIONAL LATIN AMERICAN  
CONGRESS ON NATURAL AND APPLIED SCIENCES**

The results revealed that the mean age of the selected population is 51 years with a predominance of the age group 50 to 59 years. The proportions of luminal A, luminal B, TNBC and HER2 breast cancer subtypes were 23.5%, 49.51%, 16.8% and 10.5%, respectively. The invasive ductal carcinoma (IDC) was the most common histological type (85.4%) followed by the invasive lobular carcinoma (9.5%), The SBR grade II was the most common in the population. We noticed a higher frequency of IDC in the young [40 - 49 y] and middle aged groups [50 - 59 y], while all the IDC were of Luminal B molecular type.

Although our results are preliminary, some of them are concordant with other Algerian studies. A more extended molecular and immunohistological characterization is ongoing.

**Key words:** Breast Cancer, Histological type, sub-molecular type, Aures region, immunohistochemistry

**4TH INTERNATIONAL LATIN AMERICAN  
CONGRESS ON NATURAL AND APPLIED SCIENCES**

**MORUS ALBA; A RAY OF HOPE FOR MENTAL ILLNESSES**

**Sidra Mohiuddin Soofi**

Correspondence Author: Dr Afshan Siddiq, Associate Professor Department of  
Pharmacology, Faculty of Pharmacy and Pharmaceutical sciences, University of Karachi,  
Karachi Pakistan.

**Dr. Afshan Siddiq**

Correspondence Author: Dr Afshan Siddiq, Associate Professor Department of  
Pharmacology, Faculty of Pharmacy and Pharmaceutical sciences, University of Karachi,  
Karachi Pakistan.

**ABSTRACT:**

Over the years, plants have been used in treatment of various health ailments. *Morus alba* also known as White Mulberry is a deciduous tree which belongs to family *Moraceae*. Mulberry is rich in antioxidants such as hydrophobic flavonoids, polyphenols, carotenoids, vitamin A, C and E. This study analyses the central nervous system activities including memory enhancement, learning abilities, changes in behavior, cognition, anxiety and depression. These effects will be studied on experimental mice, which will be distributed in control and test groups. Aqueous fruit extract prepared by Maceration extraction will be given to test group in three different doses per oral over a time period of 30 days, whereas control will be given water for injection for same duration. Afterwards, changes in aforementioned effects will be observed to determine the pharmacological effects of plant.

**Key Words** *Morus alba* White Mulberry Anxiolytic Cognition Antidepressant Antioxidant Maceration

**4TH INTERNATIONAL LATIN AMERICAN  
CONGRESS ON NATURAL AND APPLIED SCIENCES**

**MOSQUITO VECTOR ABUNDANCE AND DISTRIBUTION ASSOCIATED WITH  
THE PREVALENCE OF MALARIA IN ZANGO LOCAL GOVERNMENT AREA,  
KATSINA STATE, NIGERIA**

**Yusuf Rabe**

Department of Biological Sciences, Faculty of Science, Nigerian Defence Academy, P.M.B.  
2109, Kaduna, Kaduna State, Nigeria

**Yusuf Muhammad Sanyinna**

Department of Biology, Faculty of Natural and Applied Sciences, Nigerian Army University  
Biu, P.M.B. 1500, Biu, Borno State, Nigeria

**Abdulhamid Ahmed**

Department of Animal and Environmental Biology, Faculty of Life Sciences, Kebbi State  
University of Science and Technology, P.M.B. 1144, Aliero, Kebbi State, Nigeria

**ABSTRACT**

Mosquitoes are group of small insects distributed among 41 genera and about 3500 species responsible for transmitting malaria and other infectious diseases worldwide. This study examined mosquito vector abundance and distribution associated with the prevalence of malaria in Zango Local Government Area, Katsina State, Nigeria. This is a descriptive cross sectional research that employed survey and laboratory practical to generate data. A total of 305 individuals involving pregnant women, children and other patients attending the selected Health Centres randomly selected from 4 communities were examined. Eight houses were randomly selected from each community for entomological studies of indoor-biting and resting mosquitoes. Ladles/pipetting were used for collection of larvae in small ground pools, earthen pots and discarded tyres whereas dipping method was used to collect larvae in large breeding sites such as ponds and dams. MS-Excel and Graph Pad Instat software were used for data analysis. Five hundred and thirty one (531) mosquito larvae and 785 adult mosquitoes were collected from 35 breeding sites and 32 households respectively. Majority of the larvae collected belong to the genus *Anopheles* with *A. gambiae* species accounting for 56.3%. The adult mosquito species collected were identified as: *Anopheles gambiae* (69.2%), *Anopheles arabiensis* (5.7%) and *Anopheles funestus* (4.5%), while non- malaria vectors are: *Culex quinquefasciatus* (14.4%) and *Aedes aegypti* (6.2%) respectively. The prevalence of *Plasmodium falciparum* infection among the subject was 59.0%. This study provides a baseline data on the mosquito vector species (especially *Anopheles*) in the area, giving an insight into the high prevalence of malaria recorded in the locality. Proper environmental sanitation, proper sewage system, clearing bushes around house and any possible mosquito breeding sites are therefore, recommended.

**Keywords:** Mosquito; Abundance; Distribution; Prevalence; Malaria; Zango Local Government Area.

**4TH INTERNATIONAL LATIN AMERICAN  
CONGRESS ON NATURAL AND APPLIED SCIENCES**

**TRENDS AND ROLE OF PHARMACIST IN COMMUNITY PHARMACY  
SERVICES AND FACILITATION PROTOCOL: CHALLENGES IN REAL TIME  
PRACTICES**

**Prof. Dr. Huma Ali**

Institute of Pharmaceutical Sciences, Jinnah Sindh Medical University, Pakistan.

**Dr. Saba Zubair**

Institute of Pharmaceutical Sciences, Jinnah Sindh Medical University, Pakistan.

**ABSTRACT**

**Background:** Community Pharmacy is most debatable part of practice in Pakistan with respect to its application and existence. There are many reasons behind the implications of long-term growth plans of this valuable Practice. In Pakistan major challenges associated may be enlisted as lack of significant information, least priority from higher stack holders, less incentive in terms of job and retention, limited opportunities, no mass level communication for pharmacy setups offering community services, ranges of services offered and trained staff availability, absence of counselling and education activities, limited media coverage and social responsibility, prioritizes and resources allocation and maintenance. **Study Design and Methodology:** A cross sectional descriptive study design was used to evaluate the information and perception of public towards community pharmacy setup in Pakistan and role of Pharmacist in drugs management system. Moreover multiple groups of Pharmacy related professionals including community pharmacist's, technician and other healthcare professionals were also included to determine the related practices and scope of work. Data Collection was carried out using a well constructed questionnaire and validation was performed prior to this study. **Results:** Values of Cronbach's alpha and spearman correlation were found satisfactory. It was revealed during the study that pharmacist's recognition at mass level is comparatively very low in this region. Moreover costly community related services are one other discouraging factor from public perspective. Basic health indicators are relatively low and people's levels of knowledge was much less towards any available pharmacy services. **Conclusion:** Incentive should be attractive to maintain long-term relationships and growth of community pharmacy service. Service providers and public relations must be encouraged to build with proper media support towards better quality of medication provisions in presence of trained and qualified pharmacist. Campaigns for education and awareness should be placed on regular basis in various territories across the country. All stakeholders should develop a reflective practice model with clear provision of policies and feedback to improve and expand community services in order to improve better system.

**Keywords:** Community Pharmacy Pharmacist role , real time Challenges and practice, policy, service



GLUCOSE TRANSPORTERS IN CANCER METABOLISM  
KANSER METABOLİZMASINDAKİ GLUKOZ TAŞIYICILARI

Özgür Ülkü ÖZDEMİR

Sivas Cumhuriyet Üniversitesi, ORCID NO: 0009-0005-5563-5200

Şeyda BERK

Dr. Öğretim Üyesi, Sivas Cumhuriyet Üniversitesi, ORCID: 0000-0003-4687-0223

ÖZET

Kontrolsüz, sonsuz çoğalma, tümörlerin temel bir özelliğidir. Bu nedenle, son araştırmalar, kanser hücreleri ve normal hücreler arasındaki metabolik süreçlerdeki farklılıkları vurgulamaktadır. Kanser tedavisinde hastanın sağ kalımını ve yaşam kalitesini artırmak çok önemlidir ve bu alanda önemli gelişmeler olmuştur. Buna rağmen kansere bağlı ölümlerde sürekli artışlar gözlenmektedir. Kanser hücresi gelişiminin ayırt edici özelliklerinden biri, yeni biyokütle üretimi ve besin sinyalleşmesini kolaylaştırmak için gerekli hücre metabolitlerin artan üretimi için aerobik glikolize yakıt sağlamak için glukozu artan bağımlılıktır. Kanser hücrelerinin, oksijen varlığında bile ATP üretme aracı olarak glikolizin tercihli kullanımına başvurmaları Warburg etkisi olarak tanımlanmıştır. Glukozun hücre homeostaz ve metabolizmada merkezi bir rol oynaması nedeniyle, memeli hücrelerinin plazma zarı boyunca glukozun taşınması, en önemli hücre besin taşıma olaylarından birini temsil etmektedir. Neredeyse tüm memeli hücrelerinin plazma zarlarının, kolaylaştırıcı difüzyon tipinde glukoz için bir taşıma sistemine sahip olduğu uzun zamandır tespit edilmiştir; bu taşıyıcılar, glukozun hücre içine veya dışına kimyasal gradyanı boyunca plazma zarı boyunca hareketine izin vermektedir. Aerobik glikolizin mitokondriyal solunumdan çok daha az verimli olduğu ve son yıllarda araştırmacıların kanser hücrelerinin bu yolu kullanmasının nedenlerinden biri, kanser hücresi büyümesinde önemli olan hücre sinyal yollarının metabolik yolların düzenlenmesidir. Metabolik yolların bu düzenlenmesinin önemi, bunun hücre çoğalması için gerekli olan besinlerin biyokütleyle dahil edilmesini kolaylaştırmasıdır. Ayrıca, örneğin *c-myc*, *ras* ve *src* gibi bazı onkogenlerin aktivasyonunun ve hipoksi ile indüklenebilir faktör-la gibi transkripsiyon faktörlerinin aşırı ekspresyonu ve glikolitik enzimlerin ve glukoz taşıyıcıların (GLUT) aktivitesini indükleyebildiği birçok çalışmada ispatlanmıştır. Glukozun hücre homeostaz ve metabolizmada merkezi bir rol oynaması nedeniyle, memeli hücrelerinin plazma zarı boyunca glukozun taşınması, en önemli hücre besin taşıma olaylarından birini temsil etmektedir. Neredeyse tüm memeli hücrelerinin plazma zarlarının, kolaylaştırıcı difüzyon tipinde glukoz için bir taşıma sistemine sahip olduğu uzun zamandır tespit edilmiştir; bu taşıyıcılar, glukozun hücre içine veya dışına kimyasal gradyanı boyunca plazma zarı boyunca hareketine izin vermektedir. Bu taşıyıcılar, glukozun D-enantiyomerine özgüdür ve ATP (Adenozin trifosfat) hidrolizi veya bir H<sup>+</sup> gradyanı gibi enerji gerektiren herhangi bir bileşene bağlanmamaktadır. Kolaylaştırıcı glukoz taşıyıcıları, aktif olarak glukoz biriktiren Na<sup>+</sup> bağımlı taşıyıcılardan farklıdır. Glukoz taşıyıcıları (GLUT) arasında, GLUT1'in glukoz için yüksek bir afinitesi vardır ve bu nedenle, enerji için glukozu yüksek oranda bağımlı olan dokularda önemli bir rol oynamaktadır. GLUT1 dahi olmak üzere diğer glukoz taşıyıcılarının hem katı hem de hematolojik

## 4TH INTERNATIONAL LATIN AMERICAN CONGRESS ON NATURAL AND APPLIED SCIENCES

malignitelerin çeşitli türlerinde eksprese edildiği çeşitli çalışmalarla elde edilmiştir ve bu kanserlerde, glukoz taşıyıcıların aşırı ekspresyonunun derecesinin tümörün derecesi, kanserin evresi ve klinik sonuçla ilişkili olduğu dair veriler mevcuttur. Glukozun bir hücreye kolaylaştırıcı girişini sağlayan GLUT'ların, kanserde artan bir şekilde serbest bırakıldığı bulunmuştur. GLUT'lar için kansere özgü ekspresyon paternleri tanımlanıyor olsa da bireysel GLUT'lar için bir rolü kanıtlayan kapsamlı analizler hala gereklidir.

**Anahtar Kelimeler:** Kanser metabolizması, Glukoz taşıyıcıları, Warburg etkisi

### ABSTRACT

One of the main characteristics of tumors is unchecked, unending expansion. The variations in metabolic processes between cancer cells and normal cells are thus highlighted by recent studies. Enhancing patient survival and quality of life during cancer therapy is crucial, and there have been considerable advancements in this field. Despite this, the number of deaths from cancer is continuing to rise. The increasing reliance on glucose to power aerobic glycolysis for the synthesis of new biomass and the increased generation of cellular metabolites required to promote nutritional signaling are characteristics of cancer cell development. The Warburg effect is characterized by cancer cells' preference for glycolysis over other ATP-producing processes, even when oxygen is present. One of the most significant cellular nutrient transport processes involves the movement of glucose across the plasma membrane of mammalian cells since glucose is essential for cellular homeostasis and metabolism. It has long been known that almost all mammalian cells feature facilitative diffusion-type glucose transport systems in their plasma membranes, which allow glucose to move into or out of the cell along a chemical gradient across the plasma membrane. Aerobic glycolysis is significantly less effective than mitochondrial respiration, however researchers have recently exploited this method for cancer cells due to the regulation of metabolic pathways and cell signaling pathways that are crucial for the proliferation of cancer cells. This metabolic pathway control is significant because it makes it easier to incorporate nutrients needed for cell proliferation into the biomass. Also, it has been demonstrated in numerous studies that various oncogenes, including c-myc, ras, and src, as well as excessive production of transcription factors such hypoxia-inducible factor- $\alpha$ , can activate glycolytic enzymes and glucose transporters (GLUT). The movement of glucose through the plasma membrane of mammalian cells is one of the most significant cellular nutrient transport processes because glucose is essential for cellular homeostasis and metabolism. It has long been known that practically all mammalian cells' plasma membranes have a glucose transport system of the facilitator diffusion type. These transporters allow glucose to go in or out of the cell via the chemical gradient across the plasma membrane. These transporters are specialized for the D-enantiomer of glucose and don't bind to any substances that need energy to function, including an  $H^+$  gradient or ATP (adenosine triphosphate) hydrolysis. Different from  $Na^+$  dependent transporters, which actively collect glucose, are facilitating glucose transporters. As GLUT1 is one of the glucose transporters with a high affinity for glucose, it is crucial in tissues that depend heavily on glucose for energy. There is evidence that additional glucose transporters, including GLUT1, are overexpressed in a variety of solid and haematological tumors, and that this overexpression is correlated with the tumor grade, cancer stage, and clinical outcome in these cancers. It has been discovered that GLUTs are released more frequently in cancer. GLUTs help glucose enter a cell. Comprehensive analyses showing a role for specific GLUTs are still needed despite the discovery of cancer-specific expression patterns for GLUTs.

**Keywords:** Cancer metabolism, Glucose Transporters, Warburg effect

## **GİRİŞ**

Kanser metabolizmasının kökleri, mitokondriyal solunum zinciri kompleksi IV 1'i keşfiyle 1931 Nobel Tıp veya Fizyoloji Ödülü sahibi Otto Warburg tarafından yapılan gözlemlere dayanmaktadır. Warburg, normal dokularla karşılaştırıldığında, *in vitro* kanser dokusu dilimlerinin, oksijen varlığında bile laktat üretmek için bol miktarda glukoz kullandığını gözlemledi. Bu, aerobik glukoliz veya Warburg etkisi olarak adlandırılan bir olgudur (Warburg, 1956). Kanser hücrelerinin çoğu, tümör büyümesi için trikarboksilik asit (TCA) döngüsü boyunca akışı teşvik etmek için solunum yapar (Bonekamp et al., 2020; DeBerardinis & Chandel, 2020; Hollinshead et al., 2020; Krall et al., 2021; Martínez-Reyes et al., 2020; Vasan et al., 2020). Solunum yapmayan ancak yine de büyüme için gerekli metabolitleri sağlamak üzere TCA döngüsünü kullanan tümörler vardır (Cardaci et al., 2015). Bununla birlikte, Warburg etkisi hem kanserli fare modellerinde hem de kanserli insan hastalarda *in vitro* ve *in vivo* olarak gözlemlenebilen gerçek bir olgudur (Engelman et al., 2008; Gatenby & Gillies, 2004). Son 25 yılda kanser metabolizmasının yeniden canlanması, kanser hücrelerinin neden Warburg etkisini sergilediğini açıklamaya yardımcı olan keşiflerle aynı zamana denk geliyor (Vander Heiden et al., 2009). 1990'larda, glukolitik enzim laktat dehidrojenaz A'nın (LDHA) *miyelositomatozis viral onkogen homologu (MYC)*'nin transkripsiyonel bir hedefi olduğu ve kanser hücrelerinin artan glukoliz ve tümörjenik potansiyeli için gerekli olduğu kabul edildi. Böylece Warburg etkisi için moleküler bir temel sağlamaktadır (Shim et al., 1997). Ayrıca, kanserde sıklıkla serbest bırakılan ve tümörün hayatta kalması ve büyümesi için gerekli olan *AKT serin-treonin kinaz (AKT)*, *Rapamisin protein kompleksinin memeli hedefi (mTOR)* ve hipoksi ile indüklenebilir faktörler (HIF'ler) de 1990'larda keşfedilmiştir (Hoxhaj & Manning, 2020; Hurst, 2016; Sabatini, 2017). Bu yollar, glukoz taşıyıcılarının ve glukolitik enzimlerin transkripsiyonel yukarı regülasyonu ve fosforilasyonu yoluyla bireysel olarak glukolizi artırır (Hoxhaj & Manning, 2020; Hurst, 2016; Sabatini, 2017).

### **Glukoz Taşıyıcı Ailesi:**

GLUT'ların ana işlevi, metabolizma için glukozun sürekli kullanılabilirliğini sağlamaktır ve bunu glukozun hücre içi ve hücre dışı bölmeler arasındaki hareketini kontrol ederek yaparlar (Augustin, 2010; Medina & Owen, 2002). GLUT ailesinin genleri, 2A çözünen taşıyıcı ailesine aittir ve *SLC2A* gen sembolüne sahiptirler. Şu anda açıklanan *GLUT* genlerinin 14 izoformu vardır ve bu izoformlar, birincil sekanslarına göre üç sınıfa ayrılabilir (Augustin, 2010; Krzeslak et al., 2012; Macheda et al., 2005). Birinci sınıf genler (sınıf I) klasik taşıyıcılar olarak bilinir ve *GLUT 1-4* ve *GLUT*'tan oluşur. 14, *GLUT 3*'ün gen kopyası olarak kabul edilir. Sınıf II, *GLUT 5, 7, 9* ve *11*'den oluşurken, sınıf III, *GLUT 6, 8, 10, 12* ve *13*'ten oluşur. H<sup>+</sup> miyoinositol taşıyıcı (HMIT) olarak bilinir (Macheda et al., 2005).

*GLUT*'ların pek çok izoformu mevcut olmasına rağmen, büyük, oldukça korunmuş bir transmembran alanı ve asimetric, daha az korunmuş bir sitoplazmik ve ekzoplazmik alan ile benzer transmembran anatomisine sahiptirler (Medina & Owen, 2002). Bununla birlikte, hücre altı lokalizasyon, substrat tanıma ve taşıma kinetiği açısından işlevlerinde farklılık gösterirler (Macheda et al., 2005; Medina & Owen, 2002). 14 izoform, kendi aralarında %14-63 oranında özdeş protein dizilerine sahiptir ve bunların %30-79'u korunur (Augustin, 2010). Tüm izoformlar aynı zamanda *GLUT 1* için orijinal hidropati grafiğine dayanan 12 transmembran sarmalına sahiptir. Farklı *GLUT*'lar dokuda çeşitli dağılımlara sahiptir ve genellikle hücreye özgüdür. Ayrıca glukoz, fruktoz ve galaktoz gibi diğer heksozlara karşı farklı afiniteleri vardır (Augustin, 2010; Macheda et al., 2005; Medina & Owen, 2002).

### **Glukoz Taşıyıcı Sınıf I:**

Bu GLUT ailesi, tanımlanan ilk gruptur ve en karakterize edilen gruptur. *GLUT 1* ve *GLUT 4* en çok çalışılanlardır (Frolova & Moley, 2011). 1985 yılında, *GLUT 1* klonlanan ilk izoform olmuştur. *GLUT1* eritrositler, plasenta, endotelial hücrelerde eksprese edilir ve bu nedenle kan-beyin bariyerinden girişi düzenler; büyüme faktörleri, insülin ve stres varlığında, hücrel farklılaşma ve transformasyon koşullarında değiştiği bulunmuştur (Jun et al., 2011). Diğer *GLUT*'larla karşılaştırıldığında, *GLUT1*'in glukoz için yüksek afinitesi vardır ve bu nedenle enerji için glukozu yüksek oranda bağımlı olan dokularda önemli bir rol oynar (Luo et al., 2010). *GLUT1*'in çeşitli katı ve hematolojik malignitelerde aşırı eksprese edildiği bulunmuştur (Grabellus et al., 2012; Jun et al., 2011). *GLUT 1*'in aşırı eksprese edildiği kanser çeşitleri arasında, bunlarla sınırlı olmamak üzere, diffüz büyük B hücreli lenfoma, kolorektal karsinomlar, hepatoselüler karsinom, baş ve boyun kanseri, gastrointestinal stromal tümör (GIST), prostat karsinomu, tiroid karsinomu, böbrek hücreli kanser, akciğer kanseri, pankreas kanseri, sarkomlar ve gırtlak karsinomlarıdır. Bu kanserlerde, *GLUT1* aşırı ekspresyon derecesinin tümörün derecesi, kanserin evresi ve klinik sonuç ile ilişkili olduğu konseptine karşı olan ve olmayan veriler vardır (Carvalho et al., 2011; Luo et al., 2010; Reinicke et al., 2012).

*GLUT4* kalp, iskelet ve kas dokusu gibi genellikle insüline duyarlı dokularda bulunur. Tip II şeker hastalığı ve obezitede geniş çapta çalışılmıştır ve tümörü-genezdeki rolü daha az ölçüde incelenmiştir (Augustin, 2010). *GLUT4*'ün uyarılması ve ardından dokuda glukoz alımı, fosfatidilinositol 3-kinaz-AKT yolunun aktivasyonu ile ilişkilendirilmiştir. *GLUT4*'ün çoklu miyelom hücre canlılığını ve proliferasyonunu sürdürmede kilit bir rol oynadığını görülmüştür (McBrayer et al., 2012). İmatinib ile tedaviden sonra GIST hücrelerinde plazma zarında bulunan *GLUT4*'te bir azalma olduğu da görülmüştür (Tarn et al., 2006). Bunun, plazma zarından *GLUT4*'ün endositozunun veya hücre içi mikrozomların tecrit edilmesinin bir sonucu olduğu ve *AKT*'nin ekspresyonundan bağımsız olduğunu bu da *GLUT4*'ün bu kanserlerin idamesindeki rolünün altını çizmektedir (Tarn et al., 2006).

Hiperbolik eğrinin denklemi olan Michaelis-Menten denkleminin türetilen Lineweaver-Burk denklemi olan (Km)'si yaklaşık 17 mmol/l olan *GLUT2*, glukoz için en düşük afiniteye sahiptir. İnce bağırsak, böbrek, meme, insülinoma, kolon ve pankreasın kanser hücre hatlarında ifade edilmiştir. *GLUT2* ve *GLUT5*, insanlarda fruktoz taşınmasında birincil olarak belirtilen taşıyıcılardır, ancak *GLUT2*, *GLUT5*'ten daha az ölçüdedir (Augustin, 2010; Medina & Owen, 2002; Reinicke et al., 2012). *GLUT3*, nispeten iyi çalışılmış ve ağırlıklı olarak beyinde eksprese edildiği bulunan, bu sınıftaki başka bir taşıyıcıdır. Bununla birlikte plasenta ve testisler gibi yüksek glukoz ihtiyacı olan dokularda da bulunur (Augustin, 2010). *GLUT3*'ün araştırıldığı kanser hücre dizileri arasında meme, koriokarsinom, yumurtalık, kolorektal, retinoblastom ve rabdomiyosarkom yer alır (Medina & Owen, 2002). *GLUT 3*'ün düzenlenmesinde tümör *proteini 53*'ün (*P53*) rolüne ilişkin çelişkili raporlar vardır; *GLUT 3* ekspresyonunun *p53*'ten bağımsız bir yolla düzenlendiğine dair raporlar varken başka bir grup, *p53* vahşi tipin aşırı ekspresyonunun *GLUT 3* supresyonuna yol açtığını öne sürmektedir (Kawauchi et al., 2008; Watanabe et al., 2010).

### **Glukoz Taşıyıcı Sınıf II:**

Bu GLUT grubu bazen 'farklı' GLUT'lar olarak anılır ve bu sınıfın başlıca özelliği fruktozu taşıma yetenekleridir (Medina & Owen, 2002). GLUT 2 ve GLUT 5, tarihsel olarak insan fruktoz naklinde belirtilen taşıyıcılardı, ancak daha yakın zamanlarda bu sınıftaki diğer GLUT'ların fruktoz taşınmasındaki rolü tarif edilmiştir (Augustin, 2010; Reinicke et al., 2012).

## 4TH INTERNATIONAL LATIN AMERICAN CONGRESS ON NATURAL AND APPLIED SCIENCES

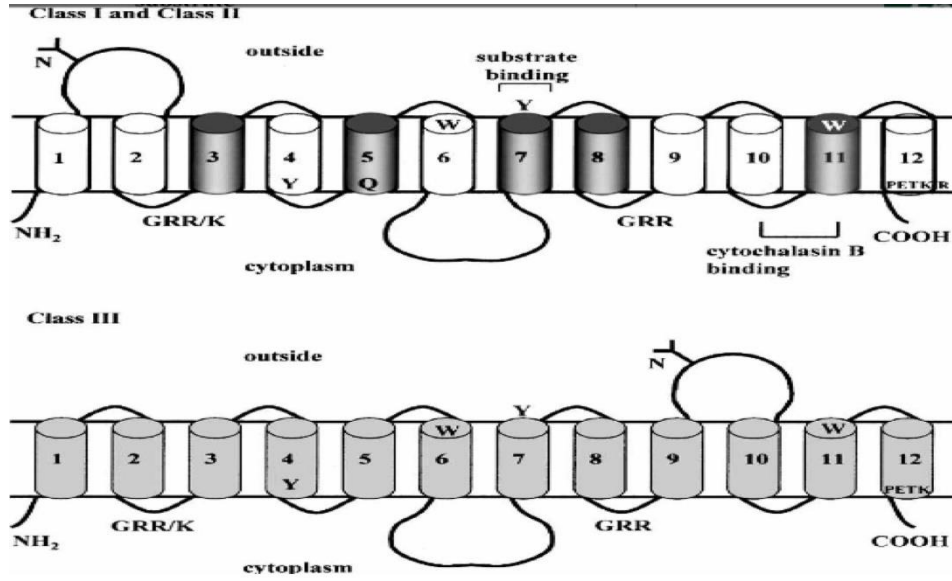
*GLUT 5* böbreklerde, testislerde, ince bağırsakta, kas ve yağ dokusunda bol miktarda bulunur. Fruktozu taşıma eyleminde oldukça spesifiktir ve diğer heksoz şekerlerini taşıma yeteneğinden yoksundur (Medina Villaamil et al., 2011). *GLUT 5*'in tümörjenezde önemli olduğu öne sürülmüştür ve örneğin renal hücreli karsinom (RCC), meme ve prostat kanseri gibi bazı kanser türlerinde normal hücrelere kıyasla aşırı eksprese edildiği bulunmuştur (Medina Villaamil et al., 2011; Reinicke et al., 2012; Wuest et al., 2011). Bu ailenin klonlanan son üyesi olan *GLUT 7*, ince bağırsakta, kolonda ve daha az oranda prostat ve testislerde eksprese edilir. İnsanlarda hem glukoz hem de fruktoz için yüksek bir afiniteye sahiptir ve kanser metabolizmasındaki rolü henüz aydınlatılmamıştır (Augustin, 2010; Cheeseman, 2008).

*GLUT 9* öncelikle karaciğer ve böbrekte bulunur, fakat aynı zamanda akciğer, lökositler ve ince bağırsakta da bulunmuştur. Bir glukoz/fruktoz taşıyıcısı olarak hareket etme kabiliyetine ilişkin değişken raporlar vardır; yakın zamanda, hiperürisemiye etkileri olan, yüksek afiniteli bir urat taşıyıcısı olduğu rapor edilmiştir (Caulfield et al., 2008). Yüksek kapasiteli bir urat taşıyıcısı olarak hareket etme yeteneğinin, kısmen heksoz şekerlerle değişimi sağlamasından kaynaklandığı öne sürülmüştür (Augustin, 2010; Caulfield et al., 2008). Bu gruptaki son taşıyıcı olan *GLUT 11*, öncelikle plazma zarında lokalizedir ve kalp, plasenta, böbrek, iskelet kası, yağ dokusu ve pankreas dahil ancak bunlarla sınırlı olmamak üzere çeşitli doku hücrelerinde bulunabilir (Augustin, 2010; McBrayer et al., 2012). Bugüne kadar üç izoform tanımlanmıştır: *GLUT 11A*, *GLUT 11B* ve *GLUT 11C* ve diğer *GLUT*'lara kıyasla fruktoz ve glukoz için nispeten düşük afiniteye sahip oldukları bilinmektedir (Augustin, 2010; McBrayer et al., 2012).

### **Glukoz Taşıyıcı Sınıf III:**

*GLUT 3* grubunun kanserdeki rolü daha az karakterize edilmiştir. *GLUT 6* ağırlıklı olarak beyin, dalak ve beyaz kan hücresinde bulunur (Augustin, 2010). Bir malignitede *GLUT 6* aşırı ekspresyonuna ilişkin tek rapor, trizomi 12 ile ilişkili kronik lenfositik lösemide bulundu ve bu aşırı ekspresyonun anlamlı olmadığı belirlendi (Porpaczy et al., 2009). *GLUT 8* rutin olarak testis, adrenal bez, karaciğer, dalak ve akciğerde eksprese edilir. Ancak son zamanlarda multipl miyelomda da aşırı eksprese edildiği bildirilmiştir (Augustin, 2010; McBrayer et al., 2012). *GLUT 12*'nin prostat ve meme kanseri hücre dizilerinin perinükleer bölgesinde ve plazma zarında lokalize olduğu bulunmuştur. Ayrıca kalp, ince bağırsak ve iskelet kasında da ifade edilmiştir (Augustin, 2010; Macheda et al., 2005). *GLUT 10* ve *GLUT 13* (HMIT) henüz spesifik kanser hücrelerinde/hatlarında karakterize edilmemiştir (Augustin, 2010; Macheda et al., 2005).





**Şekil 1:** Hücre zarındaki kolaylaştırıcı glukoz taşıyıcı proteinlerin oryantasyonunun modelleri. Transmembran alanları (TM) 1 ila 12 olarak etiketlenmiştir. Glukozilasyon (N) bölgeleri gösterilmiştir. Korunmuş alanlar ve amino asitler de dahildir. Sınıf I taşıyıcılar için, glikoz taşıma kanalını oluşturması önerilen TM'ler, gradyan gölgeleme ile vurgulanır ve heksoz substratları ve GLUT inhibitörü sitokalasin B ile etkileşime giren bölgeler belirtilir (Macheda et al., 2005).

### Kanserde Glukoz Metabolizması:

Malign hücreler metabolizmayı hızlandırır ve ATP üretimi için gereksinimleri artırır. İlk olarak Warburg tarafından kanser hücrelerinin yüksek oranda aerobik glukolize sahip olduğu gözlemlendi (Warburg, 1956). Aerobik glukoliz, piruvatı laktata dönüştüren yüksek laktat dehidrojenaz seviyeleri nedeniyle kanser hücrelerinde laktat birikmesine neden olabilir (Shim et al., 1997). Laktat dehidrojenaz, gelişmiş anaerobik glukolize izin vererek, hipoksik bir ortamda hücre büyümesi için önemli olabilir (Shim et al., 1997). Malign hücrelerde ve dokularda glukolizde yer alan enzimlerin aktivitesinde artış gözlenmiştir (Hennipman et al., 1987). Ayrıca, heksokinaz ve diğer glukolitik enzimlerin aktiviteleri, metastazlarda primer göğüs tümörlerinden daha yüksektir, bu da glukoliz ve tümör ilerlemesi arasında bir ilişki olduğunu düşündürür (Hennipman et al., 1987). Laktat dehidrojenaz aktivitesinin seviyesi, lenfoma, lösemi ve kolon kanseri için prognostik bir belirteç olarak yaygın bir şekilde kullanılmaktadır (Schwartz, 1992). Enerji üretimine ek olarak, kanser hücrelerinde daha yüksek oranlarda glukolitik akış, nükleotitlerin, yeni hücre zarları için fosfolipidlerin ve hücre bölünmesi sırasında gerekli olan diğer bileşenlerin biyosentezine yol açan öncü moleküllerin artan üretimi için de gereklidir (Newsholme & Board, 1991). Pentoz fosfat yolu, Ribonükleik asit (RNA) ve Deoksirübo nükleik asit (DNA) sentezinde kullanılmak üzere riboz-5-fosfat üretmek için glukoz-6-fosfat kullanır. Pentoz fosfat yolu enzimleri glukoz-6-fosfat dehidrojenaz ve 6-fosfoglukonat dehidrojenaz aktivitelerinin insan servikal karsinomlarında ve sıçan gliomalarında ve birkaç kanser hücre dizisinde normal hücrelere kıyasla daha yüksek olduğu bildirilmiştir (Duğu et al., 1980). Başka bir çalışma, glukoz-6-fosfat dehidrojenaz aktivitesinin, normal dokuya kıyasla habis göğüs dokusunda arttığını, ancak kanser içeren göğüslerden alınan morfolojik olarak normal dokuda da arttığını göstermektedir (McDermott et al., 1990). Bu bulgu, metabolik değişikliklerin meme kanserinde morfolojik değişikliklerden önce gelebileceğini düşündürmektedir. Laktat dehidrojenaz ve pentoz fosfat yolu enzimlerinin artan aktiviteleri, mitokondriye girmek için mevcut piruvat miktarının azalmasına neden olarak trikarboksilik asit döngüsü ve Adenozin trifosfat (ATP) üretimi ile



düşük bir oksidasyon oranına yol açar (Board et al., 1990). Yüksek enerji gereksinimleriyle birleşen düşük ATP üretim hızı, glukoliz ihtiyacının ve dolayısıyla glukoz alımının artmasına neden olur (Board et al., 1990).

### **Kanser Tedavilerinde Glukoz Taşıyıcıları:**

Erken evre hastalık, ilerlemiş primer veya metastatik tümörlerin tespiti, bir ilacın başlangıcını belirlemek, hastalık gelişimini, tedavi etkinliğini veya direncini takip etmek için esastır. Mamogramlar için X-ray görüntüleme, bilgisayarlı tomografi taraması (CT taraması) veya pozitron emisyon tomografisi (PET) taraması gibi birçok invazif olmayan teknik, tümör hacimleri, anatomisi, konumu, işlevi veya metabolizması hakkında yararlı bilgiler sağlamak için geliştirilmiştir. Metabolik görüntüleme PET taraması, tümörlerin daha yüksek glukoz alımına ve glukoliz oranına dayanır. Radyoaktif olarak işaretlenmiş glukoz analogu 2-Deoksi-2-[florin-18] florin-D-glukoz (18F-FDG) kullanır (Fass, 2008; Zhu et al., 2011). Bu radyo izleyici, GLUT'lar yoluyla hücre zarlarını geçer, daha sonra heksokinazlar tarafından FDG-6-fosfata fosforile edilir, ancak daha fazla metabolize edilemez. Bunun bir sonucu olarak, sitoplazmada birikerek artan bir hücre izleme faaliyeti ortaya çıkarır (Plathow & Weber, 2008). PET, tümör metabolizmasını izlemek için merkezi bir klinik metodoloji olmasına rağmen, bu tekniğin duyarlılığı kanser türlerine göre değişir (Kim et al., 2017; Wuest et al., 2018; Zhu et al., 2011). Bu heterojenite özellikle *GLUT1* veya *GLUT3* tümör ekspresyonu ile ilişkilendirilmiştir, çünkü 18F-FDG, glukoz taşıyıcıları ve özellikle bu iki uniporter için yüksek bir afiniteye sahiptir (Kim et al., 2017). *GLUT1* ekspresyonu ile 18F-FDG alımı arasında pozitif bir korelasyon gerçekten de servikal kanser, timik epitelyal tümörler, primer gastrik lenfoma (PGL) ve ayrıca metastatik pulmoner tümörlerde gösterilmiştir (Kaira et al., 2010; Kaira et al., 2011; Watanabe et al., 2013; Yen et al., 2004). *GLUT3* ekspresyonu ve 18F-FDG birikimi, primer merkezi sinir sistemi lenfomasında (PCNSL) bağlantılıdır (Takahashi et al., 2014). Aksine, kolorektal adenokarsinomda *GLUT1* ekspresyonu, 18F-FDG ile korele değildir. Bu sınırlamalar, glukoz dışında kullanılacak alternatif karbon kaynakları ile de açıklanabilir. Örneğin, *in vivo* deneyler, laktatın akciğer tümörlerinde baskın bir karbon yakıtı olarak kullanılabileceğini veya glutaminin pankreas kanserinde Krebs döngüsüne önemli ölçüde katkıda bulunduğunu göstermiştir (Faubert et al., 2017; Hong & Lim, 2012; Hui et al., 2017).

Pek çok kanser türü başlangıçta kemoterapiye duyarlı olsa da, direnç kaçınılmaz olarak ilaç inhibisyonunu, yıkımını veya hücre ihracatını destekleyen metabolik değişiklikler de dahil olmak üzere çok çeşitli mekanizmalar aracılığıyla ortaya çıkar (Housman et al., 2014). Kanser hücrelerinin tedaviye direnç göstermesini sağlayan farklı olasılıklar arasında glukoz taşıyıcılarının rol aldığı bildirilmektedir. Örnek olarak, glioblastoma tedavisinde kullanılan bevacizumab adı verilen antianjiyogenik Vasküler endotelyal büyüme faktörü (VEGF)-nötralize edici antikör sınırlı bir yanıt süresine sahiptir. Bevacizumab'a yanıt veren dirençli hastadan türetilen tümör ksenograftlarını karşılaştıran yakın tarihli bir çalışma, ilaca dirençli tümörlerde düşük glukoz koşullarında daha yüksek glukoz alımı, glukoliz ve sağkalımı tanımladı. Fenotipler, *GLUT3* aşırı ekspresyonu üzerine tekrar özetlenmiştir. Buna göre, *GLUT3*, bevacizumab'a dirençli ve hassas tümörlerde yukarı regüle edilmiştir (Kuang et al., 2017). Glukoz taşıyıcı ekspresyonu ile tümör anjiyogenezi arasındaki başka bir bağlantı, immünohistokimya kullanılarak *GLUT1*, *GLUT3* ve *GLUT4* ekspresyonunun VEGF'ninkiyle pozitif korelasyon gösterdiğini ortaya koyan yumurtalık karsinomu için kurulmuştur (Tsukioka et al., 2007).

Benzer bir şekilde, radyasyon tedavisi alan hastalarda ilerlemiş servikal skuamöz hücreli karsinomda radyoterapiye yanıtta ve klinik sonuçlarda *GLUT1*'in rolü araştırılmıştır. Radyasyona duyarlı grubun %53'ünde aşırı *GLUT1* ekspresyonu gözlenirken, radyasyona

## 4TH INTERNATIONAL LATIN AMERICAN CONGRESS ON NATURAL AND APPLIED SCIENCES

dirençli grupta yaklaşık %90'a ulaşılmıştır. Ayrıca, tümörlerde yüksek *GLUT1* ekspresyonu olan hastalar, düşük *GLUT1*'e sahip olanlara göre radyoterapiye karşı daha belirgin bir direnç ve daha kısa progresyonsuz sağkalım göstermektedir (Huang et al., 2014). *GLUT1*'in ayrıca, önceden tedavi edilmiş 40 tümör biyopsisinden immünohistokimya ile oral skuamöz hücreli karsinomda bir radyodirenç belirteci olduğu bulunmuştur (Kunkel et al., 2007). Son olarak, *GLUT1* boyama, insan kanser hücre dizilerinin NCI-60 panelinde kemorezistans ile bir bağlantıyı vurgulanmıştır (Evans et al., 2008). *GLUT*ların kemo- veya radyo-direncine dahil olduğu temel mekanizmalar büyük ölçüde bilinmemektedir. Bununla birlikte, birkaç çalışma, glukoliz ile anti-apoptotik gen *MCL1* arasında bir bağlantı olduğunu öne sürmektedir, bu sayede glukoliz inhibisyonu, translasyonunu bloke eder (Meynet et al., 2012; Pradelli et al., 2010). Önemli olarak, proapoptotik bir BH3-mimetik bileşik olan ABT-737 ile kombinasyon halinde kullanılan glukoliz inhibisyonu, lenfoma hücrelerinin bu ilaca duyarlılığını artırır (Meynet et al., 2012).

### SONUÇLAR:

*GLUT*lar, yetişkin dokularında glukoz taşınmasındaki rolleri açısından kapsamlı bir şekilde incelenmiştir. Kanser ilerlemesindeki işlevleri, birçok araştırmanın güncel konusudur. Bu araştırma çabaları, tümörlerde düzenlenmesi ve düzensizleştirilmesi hakkında temel bilgiler sağlamaya ve antikanser stratejilerinde onları hedeflemenin önemini vurgulamaya devam ediyor ve etmeye devam edecek. Antikanser tedavisi için, onları eksprese eden ve fizyolojik glukoz homeostazı için bunlara ihtiyaç duyan hücrelerde veya dokularda *GLUT*'ları bloke etmenin potansiyel istenmeyen etkisini dikkate almamız gerekir.

Kanser hücre hatları ile yapılan *in vitro* deneylerden birçok sonuç elde edilmiş olsa da *GLUT* düzenlemesini ve işlevini *in vivo* araştırmak, ideal olarak tümör mikroçevresinin metabolik adaptasyonunu dikkate almak için immünokompetan fare modellerinde kompleks otokton tümörlerin gelişimini incelemek kritik hale gelir. Şu anda, *GLUT* proteinlerinin kanser hücresi dışındaki etkisi büyük ölçüde keşfedilmeyi beklemektedir. Belirli hücre tiplerinde Cre rekombinaz ekspresyonunu mümkün kılan genetik yaklaşımlar, son *Glut* koşullu nakavt fareler ve kanser fare modelleri ile birleştiğinde, tümör kütlelerinin farklı hücre tiplerinde glukoz taşıyıcılarının önemini aydınlatılabilir.

Ele alınması gereken bir diğer konu da *GLUT*'lerin kimyasal inhibisyonudur. *In vivo* kimyasal yaklaşımları kullanan son çalışmalara rağmen, spesifik ve güçlü *GLUT* inhibitörleri hala eksiktir. Kristal yapıları ve homoloji tabanlı modelleri birleştiren akılcı tasarım yaklaşımları, kimyasal ekranlar için değerli bilgiler üretir. *GLUT* inhibe edici bileşiklerin keşfi, fonksiyonel karakterizasyonları için yararlı olabilir, ancak aynı zamanda kanserle savaşmak için muhtemelen geleneksel kemoterapiler veya yeni immünoterapilerle kombinasyon halinde kullanılabilecek ilaçların geliştirilmesi için de yararlı olabilir.

### KAYNAKÇA:

- Augustin, R. (2010). The protein family of glucose transport facilitators: It's not only about glucose after all. *IUBMB Life*, 62(5), 315-333. <https://doi.org/10.1002/iub.315>
- Board, M., Humm, S., & Newsholme, E. A. (1990). Maximum activities of key enzymes of glycolysis, glutaminolysis, pentose phosphate pathway and tricarboxylic acid cycle in normal, neoplastic and suppressed cells. *Biochem J*, 265(2), 503-509. <https://doi.org/10.1042/bj2650503>
- Bonekamp, N. A., Peter, B., Hillen, H. S., Felser, A., Bergbrede, T., Choidas, A., . . . Larsson, N. G. (2020). Small-molecule inhibitors of human mitochondrial DNA transcription. *Nature*, 588(7839), 712-716. <https://doi.org/10.1038/s41586-020-03048-z>

**4TH INTERNATIONAL LATIN AMERICAN  
CONGRESS ON NATURAL AND APPLIED SCIENCES**

- Cardaci, S., Zheng, L., MacKay, G., van den Broek, N. J., MacKenzie, E. D., Nixon, C., . . . Gottlieb, E. (2015). Pyruvate carboxylation enables growth of SDH-deficient cells by supporting aspartate biosynthesis. *Nat Cell Biol*, 17(10), 1317-1326. <https://doi.org/10.1038/ncb3233>
- Carvalho, K. C., Cunha, I. W., Rocha, R. M., Ayala, F. R., Cajaíba, M. M., Begnami, M. D., . . . Soares, F. A. (2011). GLUT1 expression in malignant tumors and its use as an immunodiagnostic marker. *Clinics (Sao Paulo)*, 66(6), 965-972. <https://doi.org/10.1590/s1807-59322011000600008>
- Caulfield, M. J., Munroe, P. B., O'Neill, D., Witkowska, K., Charchar, F. J., Doblado, M., . . . Cheeseman, C. (2008). SLC2A9 is a high-capacity urate transporter in humans. *PLoS Med*, 5(10), e197. <https://doi.org/10.1371/journal.pmed.0050197>
- Cheeseman, C. (2008). GLUT7: a new intestinal facilitated hexose transporter. *American Journal of Physiology-Endocrinology and Metabolism*, 295(2), E238-E241.
- DeBerardinis, R. J., & Chandel, N. S. (2020). We need to talk about the Warburg effect. *Nat Metab*, 2(2), 127-129. <https://doi.org/10.1038/s42255-020-0172-2>
- Duțu, R., Nedelea, M., Veluda, G., & Burculeț, V. (1980). Cytoenzymologic investigations on carcinomas of the cervix uteri. *Acta Cytol*, 24(2), 160-166.
- Engelman, J. A., Chen, L., Tan, X., Crosby, K., Guimaraes, A. R., Upadhyay, R., . . . Wong, K. K. (2008). Effective use of PI3K and MEK inhibitors to treat mutant Kras G12D and PIK3CA H1047R murine lung cancers. *Nat Med*, 14(12), 1351-1356. <https://doi.org/10.1038/nm.1890>
- Evans, A., Bates, V., Troy, H., Hewitt, S., Holbeck, S., Chung, Y. L., . . . Airley, R. (2008). Glut-1 as a therapeutic target: increased chemoresistance and HIF-1-independent link with cell turnover is revealed through COMPARE analysis and metabolomic studies. *Cancer Chemother Pharmacol*, 61(3), 377-393. <https://doi.org/10.1007/s00280-007-0480-1>
- Fass, L. (2008). Imaging and cancer: a review. *Mol Oncol*, 2(2), 115-152. <https://doi.org/10.1016/j.molonc.2008.04.001>
- Faubert, B., Li, K. Y., Cai, L., Hensley, C. T., Kim, J., Zacharias, L. G., . . . DeBerardinis, R. J. (2017). Lactate Metabolism in Human Lung Tumors. *Cell*, 171(2), 358-371.e359. <https://doi.org/10.1016/j.cell.2017.09.019>
- Frolova, A. I., & Moley, K. H. (2011). Glucose transporters in the uterus: an analysis of tissue distribution and proposed physiological roles. *Reproduction*, 142(2), 211-220. <https://doi.org/10.1530/rep-11-0114>
- Gatenby, R. A., & Gillies, R. J. (2004). Why do cancers have high aerobic glycolysis? *Nat Rev Cancer*, 4(11), 891-899. <https://doi.org/10.1038/nrc1478>
- Grabellus, F., Nagarajah, J., Bockisch, A., Schmid, K. W., & Sheu, S. Y. (2012). Glucose transporter 1 expression, tumor proliferation, and iodine/glucose uptake in thyroid cancer with emphasis on poorly differentiated thyroid carcinoma. *Clin Nucl Med*, 37(2), 121-127. <https://doi.org/10.1097/RLU.0b013e3182393599>
- Hennipman, A., Smits, J., van Oirschot, B., van Houwelingen, J. C., Rijksen, G., Neyt, J. P., . . . Staal, G. E. (1987). Glycolytic enzymes in breast cancer, benign breast disease and normal breast tissue. *Tumour Biol*, 8(5), 251-263. <https://doi.org/10.1159/000217529>
- Hollinshead, K. E. R., Parker, S. J., Eapen, V. V., Encarnacion-Rosado, J., Sohn, A., Oncu, T., . . . Kimmelman, A. C. (2020). Respiratory Supercomplexes Promote Mitochondrial Efficiency and Growth in Severely Hypoxic Pancreatic Cancer. *Cell Rep*, 33(1), 108231. <https://doi.org/10.1016/j.celrep.2020.108231>
- Hong, R., & Lim, S. C. (2012). <sup>18</sup>F-fluoro-2-deoxyglucose uptake on PET CT and glucose transporter 1 expression in colorectal adenocarcinoma. *World J Gastroenterol*, 18(2), 168-174. <https://doi.org/10.3748/wjg.v18.i2.168>

**4TH INTERNATIONAL LATIN AMERICAN  
CONGRESS ON NATURAL AND APPLIED SCIENCES**

- Housman, G., Byler, S., Heerboth, S., Lapinska, K., Longacre, M., Snyder, N., & Sarkar, S. (2014). Drug resistance in cancer: an overview. *Cancers (Basel)*, 6(3), 1769-1792. <https://doi.org/10.3390/cancers6031769>
- Hoxhaj, G., & Manning, B. D. (2020). The PI3K-AKT network at the interface of oncogenic signalling and cancer metabolism. *Nat Rev Cancer*, 20(2), 74-88. <https://doi.org/10.1038/s41568-019-0216-7>
- Huang, X. Q., Chen, X., Xie, X. X., Zhou, Q., Li, K., Li, S., . . . Su, J. (2014). Co-expression of CD147 and GLUT-1 indicates radiation resistance and poor prognosis in cervical squamous cell carcinoma. *Int J Clin Exp Pathol*, 7(4), 1651-1666.
- Hui, S., Ghergurovich, J. M., Morscher, R. J., Jang, C., Teng, X., Lu, W., . . . Rabinowitz, J. D. (2017). Glucose feeds the TCA cycle via circulating lactate. *Nature*, 551(7678), 115-118. <https://doi.org/10.1038/nature24057>
- Hurst, J. H. (2016). William Kaelin, Peter Ratcliffe, and Gregg Semenza receive the 2016 Albert Lasker Basic Medical Research Award. *J Clin Invest*, 126(10), 3628-3638. <https://doi.org/10.1172/jci90055>
- Jun, Y. J., Jang, S. M., Han, H. L., Lee, K. H., Jang, K. S., & Paik, S. S. (2011). Clinicopathologic significance of GLUT1 expression and its correlation with Apaf-1 in colorectal adenocarcinomas. *World J Gastroenterol*, 17(14), 1866-1873. <https://doi.org/10.3748/wjg.v17.i14.1866>
- Kaira, K., Endo, M., Abe, M., Nakagawa, K., Ohde, Y., Okumura, T., . . . Nakamura, Y. (2010). Biologic correlation of 2-[18F]-fluoro-2-deoxy-D-glucose uptake on positron emission tomography in thymic epithelial tumors. *Journal of clinical oncology*, 28(23), 3746-3753.
- Kaira, K., Okumura, T., Ohde, Y., Takahashi, T., Murakami, H., Oriuchi, N., . . . Yamamoto, N. (2011). Correlation between 18F-FDG uptake on PET and molecular biology in metastatic pulmonary tumors. *Journal of Nuclear Medicine*, 52(5), 705-711.
- Kawauchi, K., Araki, K., Tobiume, K., & Tanaka, N. (2008). p53 regulates glucose metabolism through an IKK-NF-kappaB pathway and inhibits cell transformation. *Nat Cell Biol*, 10(5), 611-618. <https://doi.org/10.1038/ncb1724>
- Kim, Y. H., Jeong, D. C., Pak, K., Han, M. E., Kim, J. Y., Liangwen, L., . . . Oh, S. O. (2017). SLC2A2 (GLUT2) as a novel prognostic factor for hepatocellular carcinoma. *Oncotarget*, 8(40), 68381-68392. <https://doi.org/10.18632/oncotarget.20266>
- Krall, A. S., Mullen, P. J., Surjono, F., Momcilovic, M., Schmid, E. W., Halbrook, C. J., . . . Christofk, H. R. (2021). Asparagine couples mitochondrial respiration to ATF4 activity and tumor growth. *Cell Metab*, 33(5), 1013-1026.e1016. <https://doi.org/10.1016/j.cmet.2021.02.001>
- Krzeslak, A., Wojcik-Krowiranda, K., Forma, E., Jozwiak, P., Romanowicz, H., Bienkiewicz, A., & Brys, M. (2012). Expression of GLUT1 and GLUT3 glucose transporters in endometrial and breast cancers. *Pathol Oncol Res*, 18(3), 721-728. <https://doi.org/10.1007/s12253-012-9500-5>
- Kuang, R., Jahangiri, A., Mascharak, S., Nguyen, A., Chandra, A., Flanigan, P. M., . . . Aghi, M. K. (2017). GLUT3 upregulation promotes metabolic reprogramming associated with antiangiogenic therapy resistance. *JCI Insight*, 2(2), e88815. <https://doi.org/10.1172/jci.insight.88815>
- Kunkel, M., Moergel, M., Stockinger, M., Jeong, J. H., Fritz, G., Lehr, H. A., & Whiteside, T. L. (2007). Overexpression of GLUT-1 is associated with resistance to radiotherapy and adverse prognosis in squamous cell carcinoma of the oral cavity. *Oral Oncol*, 43(8), 796-803. <https://doi.org/10.1016/j.oraloncology.2006.10.009>



**4TH INTERNATIONAL LATIN AMERICAN  
CONGRESS ON NATURAL AND APPLIED SCIENCES**

- Luo, X. M., Zhou, S. H., & Fan, J. (2010). Glucose transporter-1 as a new therapeutic target in laryngeal carcinoma. *J Int Med Res*, 38(6), 1885-1892. <https://doi.org/10.1177/147323001003800601>
- Macheda, M. L., Rogers, S., & Best, J. D. (2005). Molecular and cellular regulation of glucose transporter (GLUT) proteins in cancer. *J Cell Physiol*, 202(3), 654-662. <https://doi.org/10.1002/jcp.20166>
- Martínez-Reyes, I., Cardona, L. R., Kong, H., Vasan, K., McElroy, G. S., Werner, M., . . . Chandel, N. S. (2020). Mitochondrial ubiquinol oxidation is necessary for tumour growth. *Nature*, 585(7824), 288-292. <https://doi.org/10.1038/s41586-020-2475-6>
- McBrayer, S. K., Cheng, J. C., Singhal, S., Krett, N. L., Rosen, S. T., & Shanmugam, M. (2012). Multiple myeloma exhibits novel dependence on GLUT4, GLUT8, and GLUT11: implications for glucose transporter-directed therapy. *Blood*, 119(20), 4686-4697. <https://doi.org/10.1182/blood-2011-09-377846>
- McDermott, E. W., Barron, E. T., Smyth, P. P., & O'Higgins, N. J. (1990). Premorphological metabolic changes in human breast carcinogenesis. *Br J Surg*, 77(10), 1179-1182. <https://doi.org/10.1002/bjs.1800771029>
- Medina, R. A., & Owen, G. I. (2002). Glucose transporters: expression, regulation and cancer. *Biol Res*, 35(1), 9-26. <https://doi.org/10.4067/s0716-97602002000100004>
- Medina Villaamil, V., Aparicio Gallego, G., Valbuena Rubira, L., García Campelo, R., Valladares-Ayerbes, M., Grande Pulido, E., . . . Antón Aparicio, L. M. (2011). Fructose transporter GLUT5 expression in clear renal cell carcinoma. *Oncol Rep*, 25(2), 315-323. <https://doi.org/10.3892/or.2010.1096>
- Meynet, O., Bénétiau, M., Jacquin, M. A., Pradelli, L. A., Cornille, A., Carles, M., & Ricci, J. E. (2012). Glycolysis inhibition targets Mcl-1 to restore sensitivity of lymphoma cells to ABT-737-induced apoptosis. *Leukemia*, 26(5), 1145-1147. <https://doi.org/10.1038/leu.2011.327>
- Newsholme, E. A., & Board, M. (1991). Application of metabolic-control logic to fuel utilization and its significance in tumor cells. *Adv Enzyme Regul*, 31, 225-246. [https://doi.org/10.1016/0065-2571\(91\)90015-e](https://doi.org/10.1016/0065-2571(91)90015-e)
- Plathow, C., & Weber, W. A. (2008). Tumor cell metabolism imaging. *J Nucl Med*, 49 Suppl 2, 43s-63s. <https://doi.org/10.2967/jnumed.107.045930>
- Porpaczy, E., Bilban, M., Heinze, G., Gruber, M., Vanura, K., Schwarzingler, I., . . . Jaeger, U. (2009). Gene expression signature of chronic lymphocytic leukaemia with Trisomy 12. *Eur J Clin Invest*, 39(7), 568-575. <https://doi.org/10.1111/j.1365-2362.2009.02146.x>
- Pradelli, L. A., Bénétiau, M., Chauvin, C., Jacquin, M. A., Marchetti, S., Muñoz-Pinedo, C., . . . Ricci, J. E. (2010). Glycolysis inhibition sensitizes tumor cells to death receptors-induced apoptosis by AMP kinase activation leading to Mcl-1 block in translation. *Oncogene*, 29(11), 1641-1652. <https://doi.org/10.1038/onc.2009.448>
- Reinicke, K., Sotomayor, P., Cisterna, P., Delgado, C., Nualart, F., & Godoy, A. (2012). Cellular distribution of Glut-1 and Glut-5 in benign and malignant human prostate tissue. *J Cell Biochem*, 113(2), 553-562. <https://doi.org/10.1002/jcb.23379>
- Sabatini, D. M. (2017). Twenty-five years of mTOR: Uncovering the link from nutrients to growth. *Proc Natl Acad Sci U S A*, 114(45), 11818-11825. <https://doi.org/10.1073/pnas.1716173114>
- Schwartz, M. K. (1992). Enzymes as prognostic markers and therapeutic indicators in patients with cancer. *Clin Chim Acta*, 206(1-2), 77-82. [https://doi.org/10.1016/0009-8981\(92\)90008-e](https://doi.org/10.1016/0009-8981(92)90008-e)
- Shim, H., Dolde, C., Lewis, B. C., Wu, C. S., Dang, G., Jungmann, R. A., . . . Dang, C. V. (1997). c-Myc transactivation of LDH-A: implications for tumor metabolism and

**4TH INTERNATIONAL LATIN AMERICAN  
CONGRESS ON NATURAL AND APPLIED SCIENCES**

- growth. *Proc Natl Acad Sci U S A*, 94(13), 6658-6663.  
<https://doi.org/10.1073/pnas.94.13.6658>
- Takahashi, Y., Akahane, T., Yamamoto, D., Nakamura, H., Sawa, H., Nitta, K., . . . Kamada, H. (2014). Correlation between positron emission tomography findings and glucose transporter 1, 3 and L-type amino acid transporter 1 mRNA expression in primary central nervous system lymphomas. *Mol Clin Oncol*, 2(4), 525-529.  
<https://doi.org/10.3892/mco.2014.287>
- Tarn, C., Skorobogatko, Y. V., Taguchi, T., Eisenberg, B., von Mehren, M., & Godwin, A. K. (2006). Therapeutic effect of imatinib in gastrointestinal stromal tumors: AKT signaling dependent and independent mechanisms. *Cancer Res*, 66(10), 5477-5486.  
<https://doi.org/10.1158/0008-5472.Can-05-3906>
- Tsukioka, M., Matsumoto, Y., Noriyuki, M., Yoshida, C., Nobeyama, H., Yoshida, H., . . . Ishiko, O. (2007). Expression of glucose transporters in epithelial ovarian carcinoma: correlation with clinical characteristics and tumor angiogenesis. *Oncol Rep*, 18(2), 361-367.
- Vander Heiden, M. G., Cantley, L. C., & Thompson, C. B. (2009). Understanding the Warburg effect: the metabolic requirements of cell proliferation. *Science*, 324(5930), 1029-1033. <https://doi.org/10.1126/science.1160809>
- Vasan, K., Werner, M., & Chandel, N. S. (2020). Mitochondrial Metabolism as a Target for Cancer Therapy. *Cell Metab*, 32(3), 341-352.  
<https://doi.org/10.1016/j.cmet.2020.06.019>
- Warburg, O. (1956). On the origin of cancer cells. *Science*, 123(3191), 309-314.  
<https://doi.org/10.1126/science.123.3191.309>
- Watanabe, M., Naraba, H., Sakyō, T., & Kitagawa, T. (2010). DNA damage-induced modulation of GLUT3 expression is mediated through p53-independent extracellular signal-regulated kinase signaling in HeLa cells. *Mol Cancer Res*, 8(11), 1547-1557.  
<https://doi.org/10.1158/1541-7786.Mcr-10-0011>
- Watanabe, Y., Suefuji, H., Hirose, Y., Kaida, H., Suzuki, G., Uozumi, J., . . . Hayabuchi, N. (2013). 18F-FDG uptake in primary gastric malignant lymphoma correlates with glucose transporter 1 expression and histologic malignant potential. *Int J Hematol*, 97(1), 43-49. <https://doi.org/10.1007/s12185-012-1225-4>
- Wuest, M., Hamann, I., Bouvet, V., Glubrecht, D., Marshall, A., Trayner, B., . . . Wuest, F. (2018). Molecular Imaging of GLUT1 and GLUT5 in Breast Cancer: A Multitracer Positron Emission Tomography Imaging Study in Mice. *Mol Pharmacol*, 93(2), 79-89.  
<https://doi.org/10.1124/mol.117.110007>
- Wuest, M., Trayner, B. J., Grant, T. N., Jans, H.-S., Mercer, J. R., Murray, D., . . . Cheeseman, C. I. (2011). Radiopharmacological evaluation of 6-deoxy-6-[18F] fluoro-D-fructose as a radiotracer for PET imaging of GLUT5 in breast cancer. *Nuclear medicine and biology*, 38(4), 461-475.
- Yen, T. C., See, L. C., Lai, C. H., Yah-Huei, C. W., Ng, K. K., Ma, S. Y., . . . Hsueh, S. (2004). 18F-FDG uptake in squamous cell carcinoma of the cervix is correlated with glucose transporter 1 expression. *J Nucl Med*, 45(1), 22-29.
- Zhu, A., Lee, D., & Shim, H. (2011). Metabolic positron emission tomography imaging in cancer detection and therapy response. *Semin Oncol*, 38(1), 55-69.  
<https://doi.org/10.1053/j.seminoncol.2010.11.012>



**THE MOLECULAR MECHANISM OF CANCER METASTASIS**

**KANSER METASTAZININ MOLEKÜLER MEKANİZMASI**

**Rabia KALELİ**

Sivas Cumhuriyet Üniversitesi

ORCID NO: 0000-0003-0228-5727

**Şeyda BERK**

Dr. Öğretim Üyesi, Sivas Cumhuriyet Üniversitesi

ORCID: 0000-0003-4687-0223

**ÖZET**

Metastaz, kansere bağlı ölümlerin en fazlasından sorumlu olan kanserin ayırt edici özelliğidir. Metastatik tümörler erken dönemde belirginleşir ve dünya çapında kansere bağlı ölümlerin başlıca nedenlerinden biridir. Metastaz genleri, ortaklaşa istilaya ve ankraktan bağımsızlığa neden olan hedef bulma reseptörlerini, bunların ligandlarını ve hücre dışı matrisi bozan proteinazları kodlar. Bağışıklık sistemi hücrelerinin yuvalarına fizyolojik olarak aracılık eden, gelişimsel olarak temel olmayan stres tepkisi genleridir. Metastatik potansiyel, bu genlerin anormal ekspresyonu veya eklenmesiyle kanser hücrelerine kazandırılır. Kanser metastazı, birincil kanser hücrelerinin lenfatik veya kan damarları yoluyla uzak bölgelere istila ettiği süreçtir. Kanser hücrelerinin ya lenfatik ya da kan damarları yoluyla ya da her ikisi yoluyla yayıldığı moleküler mekanizmalar tam olarak belirlenmemekle birlikte bu konu üzerinde çalışmalar hala devam etmektedir. Yıllar geçtikçe metastatik sürecin verimsizliğini açıklamaya çalışmak için birçok hipotez geliştirildi, ancak bu teorilerin hiçbiri mevcut biyolojik ve klinik gözlemleri tam olarak açıklamıyor. Metastazı teşvik eden mekanizmaların sıkı bir şekilde düzenlenmesi ve buna paralel olarak kaçınan inhibitör mekanizmalar metastazın şiddetine ve bölgesine katkıda bulunur. Tümör hücresi kaderinin bireysel bir varlık olarak ve ayrıca farklı teşvik edici faktörler ve ilişkili moleküler mekanizmalarla kombinasyon halinde kapsamlı bir şekilde anlaşılması önümüzdeki yıllarda beklenmektedir. Bu, bilim adamlarının hedefe yönelik kanser tedavileri için tasarım stratejilerini tasvir etmelerini sağlayacaktır. Kanser biyolojisi araştırmalarının sürekli gelişimi ve metastaz araştırmalarında yeni paradigmanın ortaya çıkışı, bu yayılma sürecinin bazı moleküler temellerini ortaya çıkarmıştır. Metastaz, kanser hücreleri ve mikroçevreleri arasındaki çeşitli etkileşimlerin, bu hücrelerin programlanmış davranışlarını aşmasına izin veren değişiklikler sağladığı evrimsel bir sürecin son ürünüdür. Böylece tümör hücreleri yeni doku habitatlarında çoğalır ve gelişir ve sonuçta organ işlev bozukluğuna ve ölüme neden olur. Metastaza dahil olan birçok moleküler faktörü ve süreci anlamak, kanser metastazını önlemek ve tedavi etmek için etkili, hedefe yönelik yaklaşımların gelişmesine olanak sağlamaktadır. İstilacı tümör hücresi, hedef bölgeye giderken diğer proteinler ve hücrelerle etkileşime girer. Bu etkileşimlerin tanınması, metastatik hücrenin hareketliliğini ve plastisitesini yöneten bazı biyolojik ilkelerinin anlaşılmasını geliştirdi. Tümör mikroçevresi ile iletişim, istilacı kanser hücrelerinin stromal zorlukların üstesinden gelmesine, yerleşmesine ve kolonize olmasına izin verir.

**4TH INTERNATIONAL LATIN AMERICAN  
CONGRESS ON NATURAL AND APPLIED SCIENCES**

Kanser hücrelerinin bu özellikleri, tümör hücresinin kendisinde ve mikroçevresindeki genetik ve epigenetik modifikasyonlar tarafından yönlendirilir. Metastaza dahil olan moleküler ve genetik kavramların ve süreçlerin daha derinden anlaşılması, başarılı müdahaleler için açık terapötik yöntemler geliştirmek için oldukça önem taşımaktadır.

**Anahtar Kelimeler:** Kanser Metastazı; Epitelyal-Mezenkimal Dönüşüm; İnvazyon; Ekstravazasyon

**ABSTRACT**

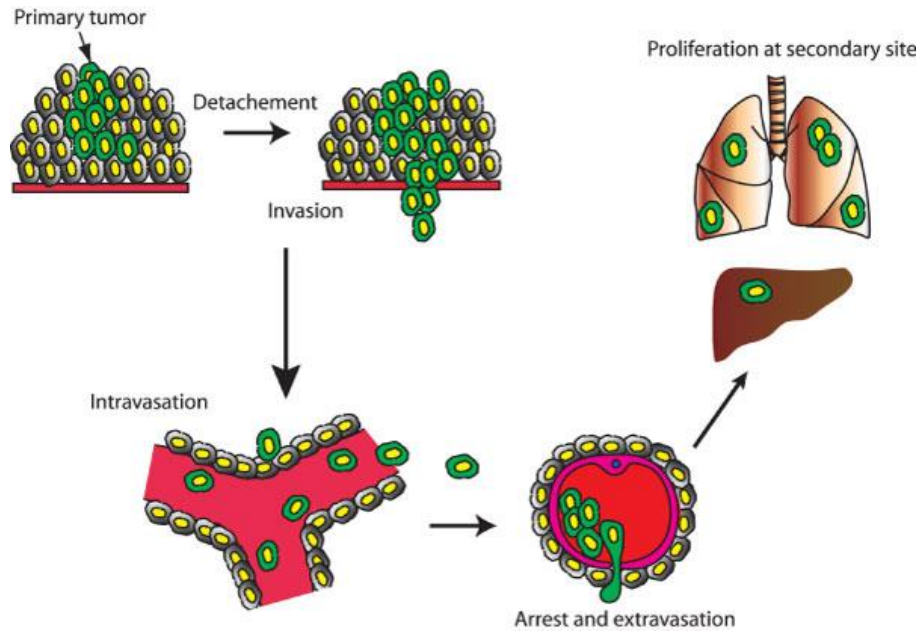
Metastasis is the hallmark of cancer, responsible for the greatest number of cancer-related deaths. Early detection of metastatic tumors, which are one of the main causes of cancer-related mortality globally. Metastasis genes encode target-finding receptors, their ligands, and proteinases that degrade the extracellular matrix, causing joint invasion and anchorage independence. These stress response genes, which are physiological mediators of immune system cell nests, are developmentally non-essential. Aberrant expression or splicing of these genes gives cancer cells the ability to spread. The process by which initial cancer cells spread to distant areas through lymphatic or blood arteries is known as cancer metastasis. Studies on this topic are still underway, despite the fact that the molecular mechanisms by which cancer cells move through lymphatic or blood vessels, or both, have not yet been fully elucidated. Over the years, a number of theories have been created to try to explain why the metastatic process is ineffective, but none of these theories entirely explains the present biological and clinical facts. The extent and location of metastasis are influenced by the strict regulation of the mechanisms encouraging metastasis and the corresponding inhibitory processes. In the upcoming years, it is anticipated that a thorough understanding of tumor cell destiny as an independent entity, as well as in combination with other stimulating stimuli and associated molecular pathways, will be achieved. This will make it possible for researchers to outline design plans for focused cancer therapies. Some of the molecular underpinnings of this diffusion process have been disclosed by the ongoing advancement of cancer biology research and the creation of new paradigms in metastasis research. The process by which cancer cells interact with their surroundings to bring about modifications that enable these cells to deviate from their preprogrammed activity results in metastasis. As a result, tumor cells multiply and grow in new tissue environments, ultimately leading to organ malfunction and death. The development of efficient, focused strategies to prevent and cure cancer metastasis is made possible by an understanding of the numerous biological variables and processes involved in metastasis. During its route to the target site, the invasive tumor cell engages in interactions with other proteins and cells. Understanding some of the basic principles that control the motility and flexibility of the metastatic cell has improved as a result of the recognition of these interactions. To overcome stromal obstacles, settle, and colonize, invasive cancer cells must communicate with the tumor microenvironment. The microenvironment and the tumor cell's own genetic and epigenetic alterations are what control these characteristics of cancer cells. To create clear therapeutic modalities for effective interventions, it is essential to have a deeper grasp of the molecular and genetic concepts and processes involved in metastasis.

**Keywords:** Cancer metastasis; Epithelial-mesenchymal transition; Invasion; Extravasation

## GİRİŞ

Metastaz, normal hücrelerin kontrolsüz çoğalan, bağışıklık sisteminden kaçan, programlanmış hücre ölümüne (apoptoz) dirençli hale gelen, anjiyogenezi uyaran, istilacı potansiyel kazanan, kan dolaşımında hayatta kalan ve kanserli büyümeler oluşturan onkojenik hücelere dönüştüğü dinamik, çok yönlü bir süreçtir (Şek. 1) (Hanahan & Weinberg, 2011). Metastatik kanser için ilk tedavi yöntemi, etkili olabilen sistemik kemoterapidir, ancak hastalar genellikle organ yetmezliği ve yüksek enfeksiyon oranları gibi ciddi yan etkilerden muzdariptir (Dillekås et al., 2019).

Kanseri etkili bir şekilde hedef alan yeni tedavilerin geliştirilmesindeki en büyük engel, metastatik süreci anlamamamızdır. Kanser ilerlemesi sırasında epitelyal-mezenkimal geçiş (EMT), epitelyal-mezenkimal plastisite (EMP) ve bağışıklık sistemi modülasyonu gibi konuların daha sağlam bir şekilde anlaşılması, daha etkili kanser tedavisinin yeni bir çağını başlatabilir (Castaneda et al., 2022)



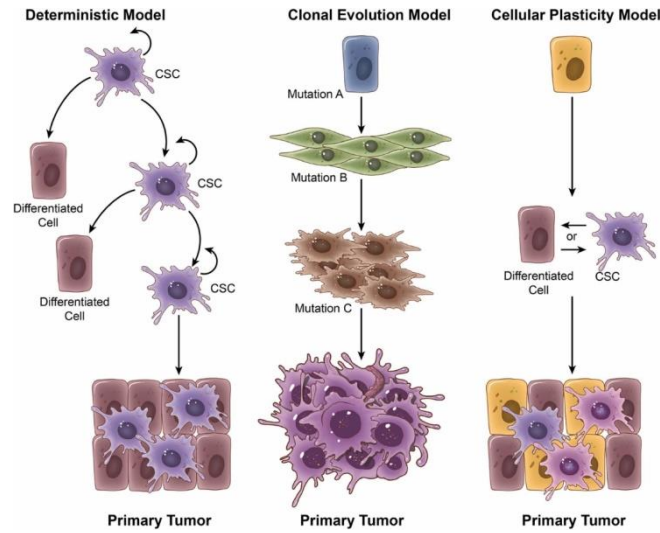
**Şekil.1** Metastatik süreç. Metastazın ilk adımları, primer tümörün proliferasyonunu ve bitişik dokular ve bazal membranlardan invazyonu gerektirir. Bu süreç, tek tek tümör hücreleri birincil tümör kütesinden ayrıldığında ve kan veya lenf yoluyla uzak bir hedef organa taşındığında, tümör kan damarlarını veya lenfatik kanalları istila edene kadar devam eder. Daha sonra, tümör hücreleri uzak organ içindeki küçük damarlarda durur, çevreleyen dokuya ekstrasvazyon yapar ve ikincil bölgede çoğalır. Tüm bu adımlar, tümör hücreleri apoptotik sinyallerden ve konakçı bağışıklık tepkilerinden kaçınırken ve hayatta kalırken gerçekleştirilmelidir (Liotta, 1989).

Metastaz, kanserin klinik yönetimi için büyük önem taşır çünkü kanser ölümlerinin çoğu birincil tümörden ziyade yayılmış hastalıkla ilişkilidir (Liotta, 1989). Kanser hastalarında sekonder tümör prevalansına rağmen, metastaz son derece verimsiz bir süreçtir. Uzak bir bölgeyi başarılı bir şekilde kolonize etmek için, bir kanser hücresi kaskadın tüm adımlarını tamamlamalıdır.

Metastatik süreçteki pek çok adımın metastatik verimsizliğe katkıda bulunduğu düşünülse de bu süreci tam olarak anlamamamız, bazı kilit düzenleyici noktaların farkında olduğumuzu ancak tümünün farkında olmadığımızı gösteriyor. (Hunter et al., 2008). Örneğin, damar içi hücrelerin hemodinamik kuvvetler ve parçalama ile yıkımının, metastatik verimsizliğin ana kaynağı olduğu düşünülmüştür (Weiss et al., 1992). Bununla birlikte, son kanıtlar bunun her zaman böyle olmayabileceğini ve kan dolaşımındaki hücrelerin kılcal yataklarda tutulduğunu ve yüksek etkinlikle damar dışına çıktığını ve ikincil bölgelerde uzun süre uykuda kaldığını göstermektedir (Luzzi et al., 1998).

## 1.Primer Tümör

Kansere kimyasal karsinogenez, viral enfeksiyonlar, epigenetik değişiklikler ve somatik mutasyonlar dahil olmak üzere çeşitli faktörler neden olur (Alexandrov et al., 2013; Sell, 2010). İki farklı model, normal hücrelerin kanser hücrelerine dönüşümü hakkındaki mevcut anlayışımızı bilgilendirmektedir (Şek. 2). Deterministik modelin savunucuları, somatik kök hücrelerin somatik mutasyonlar yoluyla dönüşümünün, kendini yenileme yeteneklerine sahip tümör hücrelerinin ayrı bir alt popülasyonunu oluşturduğunu varsayar; Bu hücreler kanser kök hücreleri (KKH) olarak bilinir (Barker et al., 2007; Singh et al., 2004).



**Şekil 2.** Tümör başlatma modelleri. Deterministik modelde (solda), KKH'ler hiyerarşik yapının tepesidir. Kendini yenileyebilen csc'lerin daha az tümörjenik farklılaşmış hücreler ürettiği varsayılmaktadır. Klonal evrim modelinde (ortada), tümör hücrelerine normal hücrelere göre üreme avantajları sağlamak için mutasyonlar veya epigenetik modifikasyonlar birikir. Hücresel plastisite modeli (sağda), csc'lerin orijin hücreleri olmadığını varsayar; bunun yerine, plastisite, heterojen bir primer tümörle sonuçlanan KKH'ler veya farklılaşmış hücreler olabilen normal hücrelerin bir özelliğidir (Castaneda et al., 2022).

Onkojenlerdeki ve tümör baskılayıcı genlerdeki mutasyonlar, kontrolsüz çoğalmaya ve hücrelerin büyümesine yol açar. Onkojenlerdeki mutasyonların sadece heterozigot olması gerekir ve onkojenin bir kopyasındaki mutasyon dönüşüm için yeterlidir (Griffiths et al., 2000). Onkojenlerin etkilerinin aksine, tümör baskılayıcılar kontrolsüz çoğalmayı dizginleme işlevi görür; *p53*'ü kodlayan gen, en iyi karakterize edilen tümör baskılayıcı genlerden biridir (Griffiths et al., 2000). *P53*, DNA hasarı üzerine stabilize edilir ve hasarlı DNA'nın replikasyonunu önlemek için hücre döngüsü durmasına neden olur. *P53* mutasyona

uğradığında, DNA hasarı meydana geldiğinde ne apoptoz ne de hücre döngüsü durması indüklenir, bu da anormal hücre döngüsü ilerlemesine ve kontrolsüz çoğalmaya yol açar (Griffiths et al., 2000). Dış stresin, besin eksikliklerinin ve oksijen eksikliklerinin, yerleşik bir birincil tümörden hücrelerin göçünü uyardığı varsayılmıştır. Bununla birlikte, *HER2+* meme kanserinde, son kanıtlar, kanser hücrelerinin, birincil tümör elle tutulur hale gelmeden önce bile yayıldığını ve dolaşımdaki kanser hücrelerinin, tümör büyümesinin ikincil bölgelerini tohumlayabildiğini göstermektedir (Harper et al., 2016).

## **2. Anjiyogenez**

Kanser hücrelerinin primer tümörden diğer bölgelere yayılmasının ana yolu anjiyogenezdir (Castaneda et al., 2022). Tümörde yeni oluşan kan damarları hatalı biçimlendirilmiş, hiperplastiktir, aşırı dallanma içerir ve oldukça geçirgen ve sızdırıcıdır, bu da tümör hücrelerinin birincil bölgeden kaçmasına izin verir (Fukumura & Jain, 2008; Weidner et al., 1991). Primer tümörlerde, besinlerin ve oksijenin optimal olmayan perfüzyonu vardır, bu da tümör içinde hipoksik ve asidik bölgelere ve yüksek interstisyel basınca neden olur (Bao et al., 2006; Shweiki et al., 1992; Zhong et al., 1999). Sızdıran vaskülatür ayrıca bağışıklık hücrelerinin düzgün çalışmasını engeller ve sistemik kemoterapi alan hastalarda kemoterapötik ilaçların tümöre taşınmasını bozar (Maeda, 2001). Anjiyojenik anahtar kapalıyken primer tümörler küçük kalır ve lokalize olur. Anjiyojenik süreç, ilk tümör oluşumundan aylar veya yıllar sonra aktive edilebilir ve tümör büyümesinin yenilenmesine, tümör hücrelerinin sürekli replikasyonuna ve kanser hücrelerinin tümörden ikincil bölgelere yayılmasına yol açar (Bielenberg & Zetter, 2015; Carmeliet & Jain, 2000; Folkman, 2002; Tonini et al., 2003). *Vasküler endotel büyüme faktörü-C (VEGF-C)* veya *Vasküler endotel büyüme faktörü-D (VEGF-D)*'nin aşırı ekspresyonu, kanser hücresi yayılmasını meditatif yapan tümörle ilişkili lenfatik damarların büyümesini destekler (Mandriota et al., 2001). Bu lenfatik damarlar, lenf düğümlerinde bulunan *kemokin ligand 21 (CCL21)* yoluyla tümöre doğru dendritik hücreler toplayarak immün baskılayıcı bir ortam yaratır (Karaman & Detmar, 2014).

## **3. Epitelyal-mezenkimal dönüşüm**

Anjiyogenez sırasında, tüm kanser hücreleri vaskülatüre girme ve hayatta kalma yeteneğine sahip değildir. Başarılı bir şekilde metastaz yapmak için tümör hücrelerinin istilacı ve kök hücre benzeri özellikler kazanması gerekir (Hanahan & Weinberg, 2011). Kanser hücreleri, EMT'nin gelişim programını ele geçirerek bu süreci gerçekleştirir (Cano et al., 2000; Mani et al., 2007; Yang et al., 2004). EMT aktivasyonu, epitel hücrelerinin apikal-bazal polaritelerini ve hücre-hücre kavşaklarını kaybetmelerine ve mezenkimal hücrelerin özellikleri olan istilacı ve göç kabiliyetleri kazanmalarına neden olur (Lamouille et al., 2014). Epitel durumundaki hücreler, sıkı, yapışık ve boşluk kavşakları yoluyla hücre-hücre etkileşimleri oluşturur (Oka et al., 1993; Tunggal et al., 2005). EMT uygulanan bir hücre popülasyonunda, aynı anda hem epitelyal hem de mezenkimal belirteçleri ekspresyon eden hücreler tespit edilir. Bu sözde hibrit E / M hücreleri, E-kadherin ve N-kadherin aracılı bağlilik yoluyla hücre-hücre etkileşimleri oluşturabilir, ancak bu etkileşimler epitel durumundakinden önemli ölçüde daha zayıftır (Mrozik et al., 2018a). Metastazın birincil itici güçleri olan daha mezenkimal özelliklere sahip hücreler, göçü ve invazyonu kolaylaştıran aktin ve vimentin içeren hücre iskeletlerine sahiptir (Lamouille et al., 2014).

EMT, *Forkhead box protein 2 (FOXC2)*, *Twist*, *Snail*, *Slug*, *Çinko parmak E-kutu-bağlama homeobox 1/2 (ZEB1/2)* ve *Gooseoid* dahil olmak üzere çoklu transkripsiyon faktörleri tarafından düzenlenir (Hollier et al., 2013; Mani et al., 2007; Taube et al., 2010; Vasaiakar et al., 2021; Yang et al., 2004). Bu transkripsiyon faktörleri, *Nörojenik lokus çentik homolog proteini (NOTCH)*, *Wingless and Int-1 (Wnt)*, *glikojen sentaz kinaz-3 beta (GSK3β)* ve

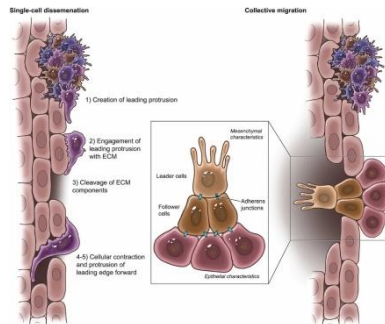


*Transforme edici büyüme faktör-beta'nın (TGFβ)* aracılık ettiği yollar da dahil olmak üzere çeşitli sinyal yollarını aktive eder ve DNA replikasyonunu, bağışıklık tepkisini ve kanser hücrelerinin istilacı ve göçmen yeteneklerini etkiler (Deshmukh et al., 2021; Kwon et al., 2016; Puisieux et al., 2014; Werden et al., 2016; Zhang et al., 2016; Zheng & Kang, 2014).

EMP, hücrelerin epitelyal ve mezenkimal durumlar arasında dönüşüm yapma yeteneği olarak tanımlanır (Hanahan & Weinberg, 2011; Kröger et al., 2019). Bu plastisite, bir mezenkimal durumun edinilmesinin göç ve invazyon için önemli olduğu, ancak metastatik tohumlamanın mezenkimal-epitel geçişi (MET) olarak bilinen bir fenomende bir epitel fenotipine geri dönüş gerektirdiği için kanser metastazı için kritiktir (Fischer et al., 2015). EMP'li hücrelerin mikro ortamdaki değişikliklere uyum sağlamak için EMT'ye maruz kalabileceği veya karşılanabileceği görülmektedir (Alix-Panabières et al., 2017; Liu et al., 2014; Pastushenko et al., 2018). EMP'li hücrelerin, EMT spektrumunun her iki ucundaki hücelere göre daha yüksek tümör başlatma ve metastatik potansiyele sahip olduğu da varsayılmaktadır (Alix-Panabières et al., 2017; Soundararajan et al., 2015).

#### 4. Invazyon

Primer tümör hücrelerinin kan dolaşımına girmesi, tek hücreli yayılma veya toplu göç yoluyla gerçekleşebilir. Her invazyon türünde yer alan hücreler spesifik morfolojik özelliklere sahiptir ve iki invazyon türünün moleküler mekanizmaları farklıdır (Yu et al., 2013). Hem tek hücreli yayılma hem de toplu göç, morfolojideki değişiklikleri ve göç yollarını oluşturmak için dokunun yeniden şekillenmesini içerir (Krakhmal et al., 2015). Tek hücreli yayılma beş adımı içerir (Şek. 3). Birincisi, önde gelen bir çıkıntı oluşturan hücre iskeletinin polarizasyonudur. İkinci adım, hücre yüzeyinde kümeler oluşturmak için önde gelen çıkıntının hücre dışı matris (ECM) ile hücre içi mekanik sinyalleme hücre dışı yapışmayı birleştirmek ve kuvvet üretmektir. Üçüncü adım, ECM bileşenlerinin bölünmesiyle sonuçlanan ön kenarın arkasındaki hücre yüzeyi proteazlarının aktivasyonudur. Dördüncü adımda, aktomiyozin hücre iskeleti yoluyla üretilen gerilim, hücresel kasılma ile sonuçlanır. Son olarak, arka kenarda yapışma bağları kopar ve bu da kanser hücrelerinin ileri hareketine neden olur (Chen et al., 2014). Tek hücreli yayılımın merkezinde, göçle ilgili streslerle başa çıkabilen sağlam bir hücre iskeleti bulunur. EMT sırasında kazanılan mezenkimal ara filament vimentin, basınç ve kayma gerilmesine karşı koruma sağlayan elastik bir ağ oluşturarak göçmen bir hücrenin strese karşı direncini güçlendirir (Hu et al., 2019; Kidd et al., 2014; Mendez et al., 2014). Nükleer membranla ilişkili ara filament lamin ayrıca mekanik strese karşı direnç sağlar. Laminler hemen hemen tüm yetişkin memeli hücrelerinde eksprese edilir ve invazyon sırasında nükleer parçalanmayı önler (Harada et al., 2014).



**Şekil 3.** Kanser ilerlemesi sırasında invazyon türleri. Kanser hücrelerinin primer tümöre bitişik kan damarlarına girmesi, tek hücreli yayılma (solda) veya toplu göç (sağda) yoluyla gerçekleşebilir. Tek hücreli yayılma, çıkıntıdan sonra mezenkimal özellikler kazanan



uyarlanabilir tek hücreleri içerir. Toplu göçün ana invazyon türü olduğuna inanılıyor. Toplu göç sırasında, bir hücre kümesi bir kan damarına girer. Ön kenar mezenkimal özelliklere sahip hücreler içerir ve takip eden hücreler epitel özelliklerine sahiptir (Castaneda et al., 2022).

Toplu göçte, yayılan hücreler, E-kadherin, N-kadherin ve *CD44* gibi adezyon molekülleri ile birbirine bağlanır (Liu et al., 2019; Mrozik et al., 2018b; Padmanaban et al., 2019; Wolf et al., 2020; Yang et al., 2019). Toplu göç, tek hücreli yayılmaya göre daha yüksek invazif ve metastatik potansiyel ile sonuçlanır (Aiello et al., 2018; Hegerfeldt et al., 2002). Toplu göç sırasında, lider hücre ile takipçi hücreler arasında gen ekspresyonu, morfolojisi ve fonksiyonunda belirgin bir fark vardır (Şek. 3) (Tambe et al., 2011). Lider hücreler, ECM'nin yeniden şekillenmesinde önemli bir rol oynar ve takip eden hücrelerden daha yüksek konsantrasyonlarda harici sinyallere maruz kalır (Bianco et al., 2007; Janssens et al., 2010). Lider hücreler, kimyasal ve mekanik sinyalleri ileten ve hücre iskeletinin yeniden düzenlenmesine, yapısal yeniden düzenlenmesine ve hücre kolektifinin morfolojik polarizasyonuna yardımcı olan integrin- $\beta 1$  gibi integrinler yoluyla ECM ile temas eder (Rørth, 2009). ECM yeniden şekillenmesi, tümör hücresi göçünün anahtarıdır ve matrisin birikmesi, matris liflerinin yeniden hizalanması ve büyüme faktörlerinin lider hücreler tarafından salgılanması, istilaya yardımcı olan mekanik strese neden olur (Lintz et al., 2017).

### **5. Intravazasyon**

İki tür intravazasyon vardır: aktif ve pasif (Bockhorn et al., 2007). Pasif intravazasyonda çoğu hücre ölür veya apoptoza uğrar (Bockhorn et al., 2007). Bu hücrelerin, tümörlerin hipoksik ortamı ve sızdıran vaskülatürü nedeniyle azalan besin kaynağı nedeniyle döküldüğüne inanılmaktadır (Bockhorn et al., 2007; Krzyszczyk et al., 2018). Aktif intravazasyon sırasında hücreler, kemotaksis süreci boyunca besin ve büyüme faktörü gradyanları boyunca bir kan damarına doğru göç eder (Roussos et al., 2011). Bu hücreler ECM'yi ve bazal membranı sindirir ve aktif olarak bir kan damarına intravazasyon yapar (Bockhorn et al., 2007). Dolaşımda, bu kanser hücreleri trombositlerle birleşerek tümör hücrelerinin kesme kuvvetine dayanmasını sağlar (Follain et al., 2020; Strilic & Offermanns, 2017). Bu dolaşımdaki tümör hücreleri içindeki EMT indüksiyonu, ara filamentlerin bu saf kuvvete dayanacak şekilde yeniden düzenlenmesine izin verir (Xin et al., 2020).

### **6. Ekstravazasyon**

Metastatik lezyonlar oluşturmak için kanser hücrelerinin, ikincil bölgedeki endotel hücrelerine yapışmayı, endotel bariyerinin modülasyonunu ve altta yatan dokuya trans-endotel göçünü içeren zorlu ekstravazasyon sürecinden geçmesi gerekir (Wang et al., 2019). Baskın ekstravazasyon şekli, tümör hücrelerinin iki endotel hücresi arasında göç ettiği paraselüler göçtür (Wang et al., 2019). Bu işlem sırasında, selektinler, kadherinler ve integrinler dahil olmak üzere birçok ligand ve reseptör, tümör hücresi ile endotel hücreleri arasındaki yapışmaya katkıda bulunur (Nieminen et al., 2006; Teo et al., 2012). Ek olarak, ekstravazasyon, trombositler, Miyeloid türevli baskılayıcı hücreler (MDSC) ve Tümör-ilişkili makrofajlar (TAM) dahil olmak üzere tümör hücreleri ile kan hücreleri arasındaki etkileşime dayanır (Wang et al., 2019). Trombositler, *Transforme edici büyüme faktör-beta1 (TGF $\beta$ 1)* ve granül türevli Adenozin trifosfat'ı (ATP) serbest bırakarak, endotel kavşaklarını modüle ederek ve tümör hücresi trans-endotel göçünü teşvik ederek invazif bir mezenkimal fenotipi indükler (Labelle et al., 2011; Stanger & Kahn, 2013; Wang et al., 2019). Miyeloid hücreler, vasküler geçirgenliği artırmak için *Vasküler endotel büyüme faktörü'nü (VEGF)* de serbest bırakan ekiplerde *Vasküler hücre adezyon proteini 1 (VCAM1)* ve *Vasküler adezyon protein 1'in (VAP1)* yukarı regülasyonunu indükler (Qian et al., 2009). Kanser hücreleri ayrıca mezenkimal özellikler kazandıktan sonra bazal yüzeylerinde invadopodia oluştururlar; Bu

## 4TH INTERNATIONAL LATIN AMERICAN CONGRESS ON NATURAL AND APPLIED SCIENCES

yapılar çıkıntılı ve yapışkandır ve endotel bariyerini yıkmak için MMP-9 ve MMP-2 gibi matris metaloproteinazları serbest bırakır (Jacob, 2015; Leong et al., 2014).

### SONUÇ

Metastaz, birden çok adımın sıralı olarak tamamlanmasını gerektiren karmaşık bir süreçtir. Tüm adımların ön koşulu, özel adaptasyonlar elde etmek için bir hücre alt kümesinin dönüştürülmesidir. Bu alt popülasyonlar, birincil tümör içinde zaten mevcut olabilir veya nesiller boyu mutasyonlardan sonra gelişebilir. İntravazasyon verimsiz bir süreçtir ve çoğu tümörü birincil konularıyla sınırlar. Bununla birlikte, bir kez intravaze edildiğinde, tümörler dolaşımında başarılı bir şekilde hayatta kalır ve verimli bir şekilde damar dışına çıkar. Kanser hücrelerinin nerede metastaz yaptığı, kemokinler, sitokinler ve büyüme faktörlerini içeren spesifik mekanizmaların yanı sıra spesifik olmayan dolaşım modelleri ve kılcal yakalama ile belirlenir. Bu, bazı onkojenlerin tümör hücrelerine yalnızca istilacı özellikler kazandırmakla kalmayıp aynı zamanda kendi kendini yenileme potansiyellerini artırma olasılığını da artırır. Bu tür yeteneklerin, yayılmış bir tümör hücresinin kendini kurması ve metastaz olarak büyümesi için çok önemli olması muhtemeldir. Metastatik kaskadın anlaşılmasındaki daha fazla ilerleme şüphesiz bize metastazı engellemek için klinik olarak ilgili ipuçları sunacaktır.

### KAYNAKÇA

- Aiello, N. M., Maddipati, R., Norgard, R. J., Balli, D., Li, J., Yuan, S., Yamazoe, T., Black, T., Sahnoud, A., Furth, E. E., Bar-Sagi, D., & Stanger, B. Z. (2018). EMT Subtype Influences Epithelial Plasticity and Mode of Cell Migration [Article]. *Developmental Cell*, 45(6), 681-695.e684. <https://doi.org/10.1016/j.devcel.2018.05.027>
- Alexandrov, L. B., Nik-Zainal, S., Wedge, D. C., Aparicio, S. A., Behjati, S., Biankin, A. V., Bignell, G. R., Bolli, N., Borg, A., & Børresen-Dale, A.-L. (2013). Signatures of mutational processes in human cancer. *Nature*, 500(7463), 415-421.
- Alix-Panabières, C., Mader, S., & Pantel, K. (2017). Epithelial-mesenchymal plasticity in circulating tumor cells. *Journal of Molecular Medicine*, 95, 133-142.
- Bao, S., Wu, Q., Sathornsumetee, S., Hao, Y., Li, Z., Hjelmeland, A. B., Shi, Q., McLendon, R. E., Bigner, D. D., & Rich, J. N. (2006). Stem cell-like glioma cells promote tumor angiogenesis through vascular endothelial growth factor. *Cancer Research*, 66(16), 7843-7848.
- Barker, N., Van Es, J. H., Kuipers, J., Kujala, P., Van Den Born, M., Cozijnsen, M., Haegebarth, A., Korving, J., Begthel, H., & Peters, P. J. (2007). Identification of stem cells in small intestine and colon by marker gene Lgr5. *Nature*, 449(7165), 1003-1007.
- Bianco, A., Poukkula, M., Cliffe, A., Mathieu, J., Luque, C. M., Fulga, T. A., & Rørth, P. (2007). Two distinct modes of guidance signalling during collective migration of border cells [Article]. *Nature*, 448(7151), 362-365. <https://doi.org/10.1038/nature05965>
- Bielenberg, D. R., & Zetter, B. R. (2015). The contribution of angiogenesis to the process of metastasis. *The Cancer Journal*, 21(4), 267-273.
- Bockhorn, M., Jain, R. K., & Munn, L. L. (2007). Active versus passive mechanisms in metastasis: do cancer cells crawl into vessels, or are they pushed? [Note]. *Lancet Oncology*, 8(5), 444-448. [https://doi.org/10.1016/S1470-2045\(07\)70140-7](https://doi.org/10.1016/S1470-2045(07)70140-7)
- Cano, A., Pérez-Moreno, M. A., Rodrigo, I., Locascio, A., Blanco, M. J., del Barrio, M. G., Portillo, F., & Nieto, M. A. (2000). The transcription factor snail controls epithelial-

**4TH INTERNATIONAL LATIN AMERICAN  
CONGRESS ON NATURAL AND APPLIED SCIENCES**

- mesenchymal transitions by repressing E-cadherin expression. *Nature cell biology*, 2(2), 76-83.
- Carmeliet, P., & Jain, R. K. (2000). Angiogenesis in cancer and other diseases. *Nature*, 407(6801), 249-257.
- Castaneda, M., den Hollander, P., Kuburich, N. A., Rosen, J. M., & Mani, S. A. (2022). Mechanisms of cancer metastasis. *Semin Cancer Biol*, 87, 17-31. <https://doi.org/10.1016/j.semcancer.2022.10.006>
- Chen, M.-S., Peng, P.-W., Liou, B.-C., Kuo, H.-C., Ou, K.-L., & Yang, T.-S. (2014). Single-molecule manipulation and detection platform for studying cancer cell chemotaxis. *Journal of Polymer Engineering*, 34(3), 259-265. <https://doi.org/doi:10.1515/polyeng-2013-0217>
- Deshmukh, A. P., Vasaikar, S. V., Tomczak, K., Tripathi, S., Den Hollander, P., Arslan, E., Chakraborty, P., Soundararajan, R., Jolly, M. K., & Rai, K. (2021). Identification of EMT signaling cross-talk and gene regulatory networks by single-cell RNA sequencing. *Proceedings of the National Academy of Sciences*, 118(19), e2102050118.
- Dillekås, H., Rogers, M. S., & Straume, O. (2019). Are 90% of deaths from cancer caused by metastases? *Cancer medicine*, 8(12), 5574-5576.
- Fischer, K. R., Durrans, A., Lee, S., Sheng, J., Li, F., Wong, S. T., Choi, H., El Rayes, T., Ryu, S., & Troeger, J. (2015). Epithelial-to-mesenchymal transition is not required for lung metastasis but contributes to chemoresistance. *Nature*, 527(7579), 472-476.
- Folkman, J. (2002). Role of angiogenesis in tumor growth and metastasis. *Seminars in oncology*,
- Follain, G., Herrmann, D., Harlepp, S., Hyenne, V., Osmani, N., Warren, S. C., Timpson, P., & Goetz, J. G. (2020). Fluids and their mechanics in tumour transit: shaping metastasis [Review]. *Nature Reviews Cancer*, 20(2), 107-124. <https://doi.org/10.1038/s41568-019-0221-x>
- Fukumura, D., & Jain, R. K. (2008). Imaging angiogenesis and the microenvironment. *Apmis*, 116(7-8), 695-715.
- Griffiths, A., Miller, J., Suzuki, D., Lewontin, R., & Gelbart, W. (2000). Cancer: the genetics of aberrant cell control. *An Introduction to Genetic Analysis*.
- Hanahan, D., & Weinberg, R. A. (2011). Hallmarks of cancer: the next generation. *cell*, 144(5), 646-674.
- Harada, T., Swift, J., Irianto, J., Shin, J.-W., Spinler, K. R., Athirasala, A., Diegmiller, R., Dingal, P. C. D. P., Ivanovska, I. L., & Discher, D. E. (2014). Nuclear lamin stiffness is a barrier to 3D migration, but softness can limit survival. *Journal of Cell Biology*, 204(5), 669-682. <https://doi.org/10.1083/jcb.201308029>
- Harper, K. L., Sosa, M. S., Entenberg, D., Hosseini, H., Cheung, J. F., Nobre, R., Avivar-Valderas, A., Nagi, C., Girnius, N., & Davis, R. J. (2016). Mechanism of early dissemination and metastasis in Her2+ mammary cancer. *Nature*, 540(7634), 588-592.
- Hegerfeldt, Y., Tusch, M., Bröcker, E. B., & Friedl, P. (2002). Collective cell movement in primary melanoma explants: Plasticity of cell-cell interaction,  $\beta$ 1-integrin function, and migration strategies [Article]. *Cancer Research*, 62(7), 2125-2130. <https://www.scopus.com/inward/record.uri?eid=2-s2.0-0036532136&partnerID=40&md5=8a2e4874025e54026923d8e85d6b7284>
- Hollier, B. G., Tinnirello, A. A., Werden, S. J., Evans, K. W., Taube, J. H., Sarkar, T. R., Sphyris, N., Shariati, M., Kumar, S. V., & Battula, V. L. (2013). FOXC2 Expression Links Epithelial–Mesenchymal Transition and Stem Cell Properties in Breast Cancer FOXC2 in EMT and Cancer Stem Cells. *Cancer Research*, 73(6), 1981-1992.
- Hu, J., Li, Y., Hao, Y., Zheng, T., Gupta, S. K., Parada, G. A., Wu, H., Lin, S., Wang, S., Zhao, X., Goldman, R. D., Cai, S., & Guo, M. (2019). High stretchability, strength,

**4TH INTERNATIONAL LATIN AMERICAN  
CONGRESS ON NATURAL AND APPLIED SCIENCES**

- and toughness of living cells enabled by hyperelastic vimentin intermediate filaments. *Proceedings of the National Academy of Sciences*, 116(35), 17175-17180.  
<https://doi.org/doi:10.1073/pnas.1903890116>
- Hunter, K. W., Crawford, N. P., & Alsarraj, J. (2008). Mechanisms of metastasis. *Breast Cancer Res*, 10 Suppl 1(Suppl 1), S2. <https://doi.org/10.1186/bcr1988>
- Jacob, T. (2015). Diving modifications for post-polio survivors: Three case studies [Article]. *Palaestra*, 29(2), 1. <https://www.scopus.com/inward/record.uri?eid=2-s2.0-85074512757&partnerID=40&md5=78a498da2ab29ea3316dc486e11e6f0b>
- Janssens, K., Sung, H. H., & Rørth, P. (2010). Direct detection of guidance receptor activity during border cell migration [Article]. *Proceedings of the National Academy of Sciences of the United States of America*, 107(16), 7323-7328.  
<https://doi.org/10.1073/pnas.0915075107>
- Karaman, S., & Detmar, M. (2014). Mechanisms of lymphatic metastasis. *The Journal of clinical investigation*, 124(3), 922-928.
- Kidd, M. E., Shumaker, D. K., & Ridge, K. M. (2014). The role of vimentin intermediate filaments in the progression of lung cancer. *Am J Respir Cell Mol Biol*, 50(1), 1-6.  
<https://doi.org/10.1165/rcmb.2013-0314TR>
- Krakhmal, N. V., Zavyalova, M. V., Denisov, E. V., Vtorushin, S. V., & Perelmuter, V. M. (2015). Cancer invasion: Patterns and mechanisms [Review]. *Acta Naturae*, 7(2), 17-28. <https://doi.org/10.32607/20758251-2015-7-2-17-28>
- Kröger, C., Afeyan, A., Mraz, J., Eaton, E. N., Reinhardt, F., Khodor, Y. L., Thiru, P., Bierie, B., Ye, X., & Burge, C. B. (2019). Acquisition of a hybrid E/M state is essential for tumorigenicity of basal breast cancer cells. *Proceedings of the National Academy of Sciences*, 116(15), 7353-7362.
- Krzyszczczyk, P., Acevedo, A., Davidoff, E. J., Timmins, L. M., Marrero-Berrios, I., Patel, M., White, C., Lowe, C., Sherba, J. J., Hartmanshenn, C., O'Neill, K. M., Balter, M. L., Fritz, Z. R., Androulakis, I. P., Schloss, R. S., & Yarmush, M. L. (2018). The growing role of precision and personalized medicine for cancer treatment. *TECHNOLOGY*, 06(03n04), 79-100. <https://doi.org/10.1142/s2339547818300020>
- Kwon, O.-J., Zhang, L., Wang, J., Su, Q., Feng, Q., Zhang, X. H., Mani, S. A., Paulter, R., Creighton, C. J., & Ittmann, M. M. (2016). Notch promotes tumor metastasis in a prostate-specific Pten-null mouse model. *The Journal of clinical investigation*, 126(7), 2626-2641.
- Labelle, M., Begum, S., & Hynes, R. (2011). Direct Signaling between Platelets and Cancer Cells Induces an Epithelial-Mesenchymal-Like Transition and Promotes Metastasis [Article]. *Cancer Cell*, 20(5), 576-590. <https://doi.org/10.1016/j.ccr.2011.09.009>
- Lamouille, S., Xu, J., & Derynck, R. (2014). Molecular mechanisms of epithelial–mesenchymal transition. *Nature reviews Molecular cell biology*, 15(3), 178-196.
- Leong, H. S., Robertson, A. E., Stoletov, K., Leith, S. J., Chin, C. A., Chien, A. E., Hague, M., Ablack, A., Carmine-Simmen, K., McPherson, V. A., Postenka, C., Turley, E. A., Courtneidge, S. A., Chambers, A. F., & Lewis, J. D. (2014). Invadopodia Are Required for Cancer Cell Extravasation and Are a Therapeutic Target for Metastasis [Article]. *Cell Reports*, 8(5), 1558-1570. <https://doi.org/10.1016/j.celrep.2014.07.050>
- Lintz, M., Muñoz, A., & Reinhart-King, C. A. (2017). The Mechanics of Single Cell and Collective Migration of Tumor Cells. *Journal of Biomechanical Engineering*, 139(2). <https://doi.org/10.1115/1.4035121>
- Liotta, L. (1989). Principles of molecular cell biology of cancer; Cancer metastases. *Cancer Principles and Practice of Oncology*, 98-115.
- Liu, S., Cong, Y., Wang, D., Sun, Y., Deng, L., Liu, Y., Martin-Trevino, R., Shang, L., McDermott, S. P., & Landis, M. D. (2014). Breast cancer stem cells transition between



**4TH INTERNATIONAL LATIN AMERICAN  
CONGRESS ON NATURAL AND APPLIED SCIENCES**

- epithelial and mesenchymal states reflective of their normal counterparts. *Stem cell reports*, 2(1), 78-91.
- Liu, X., Taftaf, R., Kawaguchi, M., Chang, Y.-F., Chen, W., Entenberg, D., Zhang, Y., Gerratana, L., Huang, S., Patel, D. B., Tsui, E., Adorno-Cruz, V., Chirieleison, S. M., Cao, Y., Harney, A. S., Patel, S., Patsialou, A., Shen, Y., Avril, S., . . . Liu, H. (2019). Homophilic CD44 Interactions Mediate Tumor Cell Aggregation and Polyclonal Metastasis in Patient-Derived Breast Cancer Models. *Cancer Discovery*, 9(1), 96-113. <https://doi.org/10.1158/2159-8290.Cd-18-0065>
- Luzzi, K. J., MacDonald, I. C., Schmidt, E. E., Kerkvliet, N., Morris, V. L., Chambers, A. F., & Groom, A. C. (1998). Multistep nature of metastatic inefficiency: dormancy of solitary cells after successful extravasation and limited survival of early micrometastases. *Am J Pathol*, 153(3), 865-873. [https://doi.org/10.1016/s0002-9440\(10\)65628-3](https://doi.org/10.1016/s0002-9440(10)65628-3)
- Maeda, H. (2001). The enhanced permeability and retention (EPR) effect in tumor vasculature: the key role of tumor-sepective macromolecular drug targeting. *Adv Enzyme Regul*, 41, 189-207.
- Mandriota, S. J., Jussila, L., Jeltsch, M., Compagni, A., Baetens, D., Prevo, R., Banerji, S., Huarte, J., Montesano, R., & Jackson, D. G. (2001). Vascular endothelial growth factor-C-mediated lymphangiogenesis promotes tumour metastasis. *The EMBO journal*, 20(4), 672-682.
- Mani, S. A., Yang, J., Brooks, M., Schwaninger, G., Zhou, A., Miura, N., Kutok, J. L., Hartwell, K., Richardson, A. L., & Weinberg, R. A. (2007). Mesenchyme Forkhead 1 (FOXC2) plays a key role in metastasis and is associated with aggressive basal-like breast cancers. *Proceedings of the National Academy of Sciences*, 104(24), 10069-10074.
- Mendez, M. G., Restle, D., & Janmey, P. A. (2014). Vimentin Enhances Cell Elastic Behavior and Protects against Compressive Stress. *Biophysical Journal*, 107(2), 314-323. <https://doi.org/https://doi.org/10.1016/j.bpj.2014.04.050>
- Mrozik, K. M., Blaschuk, O. W., Cheong, C. M., Zannettino, A. C. W., & Vandyke, K. (2018a). N-cadherin in cancer metastasis, its emerging role in haematological malignancies and potential as a therapeutic target in cancer. *BMC cancer*, 18(1), 1-16.
- Mrozik, K. M., Blaschuk, O. W., Cheong, C. M., Zannettino, A. C. W., & Vandyke, K. (2018b). N-cadherin in cancer metastasis, its emerging role in haematological malignancies and potential as a therapeutic target in cancer. *BMC cancer*, 18(1), 939. <https://doi.org/10.1186/s12885-018-4845-0>
- Nieminen, M., Henttinen, T., Merinen, M., Marttila-Ichihara, F., Eriksson, J. E., & Jalkanen, S. (2006). Vimentin function in lymphocyte adhesion and transcellular migration [Article]. *Nature cell biology*, 8(2), 156-162. <https://doi.org/10.1038/ncb1355>
- Oka, H., Shiozaki, H., Kobayashi, K., Inoue, M., Tahara, H., Kobayashi, T., Takatsuka, Y., Matsuyoshi, N., Hirano, S., & Takeichi, M. (1993). Expression of E-cadherin cell adhesion molecules in human breast cancer tissues and its relationship to metastasis. *Cancer Research*, 53(7), 1696-1701.
- Padmanaban, V., Krol, I., Suhail, Y., Szczerba, B. M., Aceto, N., Bader, J. S., & Ewald, A. J. (2019). E-cadherin is required for metastasis in multiple models of breast cancer. *Nature*, 573(7774), 439-444. <https://doi.org/10.1038/s41586-019-1526-3>
- Pastushenko, I., Brisebarre, A., Sifrim, A., Fioramonti, M., Revenco, T., Boumahdi, S., Van Keymeulen, A., Brown, D., Moers, V., & Lemaire, S. (2018). Identification of the tumour transition states occurring during EMT. *Nature*, 556(7702), 463-468.
- Puisieux, A., Brabletz, T., & Caramel, J. (2014). Oncogenic roles of EMT-inducing transcription factors. *Nature cell biology*, 16(6), 488-494.

**4TH INTERNATIONAL LATIN AMERICAN  
CONGRESS ON NATURAL AND APPLIED SCIENCES**

- Qian, B., Deng, Y., Im, J. H., Muschel, R. J., Zou, Y., Li, J., Lang, R. A., & Pollard, J. W. (2009). A Distinct Macrophage Population Mediates Metastatic Breast Cancer Cell Extravasation, Establishment and Growth. *PLOS ONE*, 4(8), e6562. <https://doi.org/10.1371/journal.pone.0006562>
- Rørth, P. (2009). Collective cell migration [Review]. *Annual Review of Cell and Developmental Biology*, 25, 407-429. <https://doi.org/10.1146/annurev.cellbio.042308.113231>
- Roussos, E. T., Condeelis, J. S., & Patsialou, A. (2011). Chemotaxis in cancer. *Nature Reviews Cancer*, 11(8), 573-587. <https://doi.org/10.1038/nrc3078>
- Sell, S. (2010). On the stem cell origin of cancer. *The American journal of pathology*, 176(6), 2584-2594.
- Shweiki, D., Itin, A., Soffer, D., & Keshet, E. (1992). Vascular endothelial growth factor induced by hypoxia may mediate hypoxia-initiated angiogenesis. *Nature*, 359(6398), 843-845.
- Singh, S. K., Hawkins, C., Clarke, I. D., Squire, J. A., Bayani, J., Hide, T., Henkelman, R. M., Cusimano, M. D., & Dirks, P. B. (2004). Identification of human brain tumour initiating cells. *Nature*, 432(7015), 396-401.
- Soundararajan, R., Paranjape, A. N., Barsan, V., Chang, J. T., & Mani, S. A. (2015). A novel embryonic plasticity gene signature that predicts metastatic competence and clinical outcome [Article]. *Scientific Reports*, 5, Article 11766. <https://doi.org/10.1038/srep11766>
- Stanger, B. Z., & Kahn, M. L. (2013). Platelets and Tumor Cells: A New Form of Border Control [Short survey]. *Cancer Cell*, 24(1), 9-11. <https://doi.org/10.1016/j.ccr.2013.06.009>
- Strilic, B., & Offermanns, S. (2017). Intravascular Survival and Extravasation of Tumor Cells [Review]. *Cancer Cell*, 32(3), 282-293. <https://doi.org/10.1016/j.ccell.2017.07.001>
- Tambe, D. T., Corey Hardin, C., Angelini, T. E., Rajendran, K., Park, C. Y., Serra-Picamal, X., Zhou, E. H., Zaman, M. H., Butler, J. P., Weitz, D. A., Fredberg, J. J., & Trepat, X. (2011). Collective cell guidance by cooperative intercellular forces [Article]. *Nature Materials*, 10(6), 469-475. <https://doi.org/10.1038/nmat3025>
- Taube, J. H., Herschkowitz, J. I., Komurov, K., Zhou, A. Y., Gupta, S., Yang, J., Hartwell, K., Onder, T. T., Gupta, P. B., & Evans, K. W. (2010). Core epithelial-to-mesenchymal transition interactome gene-expression signature is associated with claudin-low and metaplastic breast cancer subtypes. *Proceedings of the National Academy of Sciences*, 107(35), 15449-15454.
- Teo, G. S. L., Ankrum, J. A., Martinelli, R., Boetto, S. E., Simms, K., Sciuto, T. E., Dvorak, A. M., Karp, J. M., & Carman, C. V. (2012). Mesenchymal stem cells transmigrate between and directly through tumor necrosis factor- $\alpha$ -activated endothelial cells via both leukocyte-like and novel mechanisms [Article]. *Stem Cells*, 30(11), 2472-2486. <https://doi.org/10.1002/stem.1198>
- Tonini, T., Rossi, F., & Claudio, P. P. (2003). Molecular basis of angiogenesis and cancer. *Oncogene*, 22(42), 6549-6556.
- Tunggal, J. A., Helfrich, I., Schmitz, A., Schwarz, H., Günzel, D., Fromm, M., Kemler, R., Krieg, T., & Niessen, C. M. (2005). E-cadherin is essential for in vivo epidermal barrier function by regulating tight junctions. *The EMBO journal*, 24(6), 1146-1156.
- Vasaikar, S. V., Deshmukh, A. P., den Hollander, P., Addanki, S., Kuburich, N. A., Kudaravalli, S., Joseph, R., Chang, J. T., Soundararajan, R., & Mani, S. A. (2021). EMTome: A resource for pan-cancer analysis of epithelial-mesenchymal transition genes and signatures. *British journal of cancer*, 124(1), 259-269.



**4TH INTERNATIONAL LATIN AMERICAN  
CONGRESS ON NATURAL AND APPLIED SCIENCES**

- Wang, J., Li, D., Cang, H., & Guo, B. (2019). Crosstalk between cancer and immune cells: Role of tumor-associated macrophages in the tumor microenvironment [Review]. *Cancer medicine*, 8(10), 4709-4721. <https://doi.org/10.1002/cam4.2327>
- Weidner, N., Semple, J. P., Welch, W. R., & Folkman, J. (1991). Tumor angiogenesis and metastasis—correlation in invasive breast carcinoma. *New England Journal of Medicine*, 324(1), 1-8.
- Weiss, L., Nannmark, U., Johansson, B. R., & Bagge, U. (1992). Lethal deformation of cancer cells in the microcirculation: a potential rate regulator of hematogenous metastasis. *Int J Cancer*, 50(1), 103-107. <https://doi.org/10.1002/ijc.2910500121>
- Werden, S., Sphyris, N., Sarkar, T. R., Paranjape, A., LaBaff, A., Taube, J., Hollier, B., Ramirez-Peña, E., Soundararajan, R., & Den Hollander, P. (2016). Phosphorylation of serine 367 of FOXC2 by p38 regulates ZEB1 and breast cancer metastasis, without impacting primary tumor growth. *Oncogene*, 35(46), 5977-5988.
- Wolf, K. J., Shukla, P., Springer, K., Lee, S., Coombes, J. D., Choy, C. J., Kenny, S. J., Xu, K., & Kumar, S. (2020). A mode of cell adhesion and migration facilitated by CD44-dependent microtentacles. *Proceedings of the National Academy of Sciences*, 117(21), 11432-11443. <https://doi.org/doi:10.1073/pnas.1914294117>
- Xin, Y., Li, K., Yang, M., & Tan, Y. (2020). Fluid shear stress induces emt of circulating tumor cells via jnk signaling in favor of their survival during hematogenous dissemination [Article]. *International Journal of Molecular Sciences*, 21(21), 1-16, Article 8115. <https://doi.org/10.3390/ijms21218115>
- Yang, C., Cao, M., Liu, Y., He, Y., Du, Y., Zhang, G., & Gao, F. (2019). Inducible formation of leader cells driven by CD44 switching gives rise to collective invasion and metastases in luminal breast carcinomas. *Oncogene*, 38(46), 7113-7132. <https://doi.org/10.1038/s41388-019-0899-y>
- Yang, J., Mani, S. A., Donaher, J. L., Ramaswamy, S., Itzykson, R. A., Come, C., Savagner, P., Gitelman, I., Richardson, A., & Weinberg, R. A. (2004). Twist, a master regulator of morphogenesis, plays an essential role in tumor metastasis. *cell*, 117(7), 927-939.
- Yu, M., Bardia, A., Wittner, B. S., Stott, S. L., Smas, M. E., Ting, D. T., Isakoff, S. J., Ciciliano, J. C., Wells, M. N., Shah, A. M., Concannon, K. F., Donaldson, M. C., Sequist, L. V., Brachtel, E., Sgroi, D., Baselga, J., Ramaswamy, S., Toner, M., Haber, D. A., & Maheswaran, S. (2013). Circulating Breast Tumor Cells Exhibit Dynamic Changes in Epithelial and Mesenchymal Composition. *Science*, 339(6119), 580-584. <https://doi.org/doi:10.1126/science.1228522>
- Zhang, J., Tian, X.-J., & Xing, J. (2016). Signal transduction pathways of EMT induced by TGF- $\beta$ , SHH, and WNT and their crosstalks. *Journal of clinical medicine*, 5(4), 41.
- Zheng, H., & Kang, Y. (2014). Multilayer control of the EMT master regulators. *Oncogene*, 33(14), 1755-1763.
- Zhong, H., De Marzo, A. M., Laughner, E., Lim, M., Hilton, D. A., Zagzag, D., Buechler, P., Isaacs, W. B., Semenza, G. L., & Simons, J. W. (1999). Overexpression of hypoxia-inducible factor 1 $\alpha$  in common human cancers and their metastases. *Cancer Research*, 59(22), 5830-5835.

**LYMPHOCYTE LEVEL AT DIAGNOSIS IN HODGKIN LYMPHOMA: COULD IT  
BE AN INDICATOR OF THE STAGE AT INITIAL DIAGNOSIS?**

**Istemi SERIN**

University of Health Sciences, Istanbul Training and Research Hospital,

Department of Hematology

ORCID ID: 0000-0003-1855-774X

## **INTRODUCTION**

Hodgkin lymphoma (HL), formerly called Hodgkin's disease, is a rare monoclonal lymphoid hematologic malignancy with high cure rates [1]. As a result of the studies, this disease has been divided into two different subgroups: Classical Hodgkin lymphoma (cHL) and nodular lymphocyte-predominant Hodgkin lymphoma (NLP-HL). The current gold standard for advanced stage risk stratification in HL is the International Prognostic Score (IPS) [2]. Despite the existence of standard risk classification systems and effective treatment approaches, 34% to 37% of advanced stage HLs relapse or progress [3]. Therefore, for the sake of prognosis and early prediction of the stage, it is necessary to develop new easily usable parameters. Many studies have been conducted with the goal of determining the prognosis and estimation of the stage of this type of lymphoma consisting of different morphological features. In summary, from studies on tumor microenvironment and host immunity, it can be said that changes in lymphocyte ratio and subtypes constitute a new research subject. At this point, absolute monocyte count (AMC), absolute lymphocyte count (ALC) are shown as prognostic factors [4–6]. Similarly, we see that the developed parameters such as neutrophil-lymphocyte ratio are also used in determining prognosis [7]. Main aim in

present study was to show the relationship between initial lymphocyte count and stage and to examine their effects on prognosis. The initial lymphocyte count which is proven in advanced stage patients, could be an important factor in terms of showing the prognosis also in the early stage.

## **Material and method**

In this study, 190 patients diagnosed with HL between January 2010 and September 2020 were included. HL subtypes (NSHL, MCHL, LDHL, LRHL, NLP-HL), diagnosis stages, presence of bulky or mediastinal mass, lymphadenopathy areas (cervical, thoracic, abdomen, pelvis), as well as demographic data of patients such as age and gender were recorded. It was aimed to obtain a cut-off in the statistical analysis performed in order to reveal the relationship between lymphocyte level and stage, which is the main hypothesis of the study.

## **Results**

Of the 190 patients evaluated, 77 were female (40,5%), and 113 were male (59,5%). When evaluated, in terms of histological subtype, it was seen that 133 patients (70%) were diagnosed with NSHL. When mortality and affecting factors were examined, it was seen that only high leukocyte count at initial diagnosis and advanced age were associated with

mortality. To obtain a cut-off in terms of lymphocyte level and stage relationship, which is the hypothesis of our study; a value of 2380 / mm<sup>3</sup> and below was found to be associated with stage 3-4 disease with a sensitivity of 86,44% and a specificity of 33,3% (AUC: 0,613 (0,539-0,682), p <0,007)

## **Discussion**

The histological distinguishing feature of cHL is that Reed Sternberg cells form approximately 2% of the environment alongside the other tumor microenvironment. Studies have shown that the background known as the tumor microenvironment has a significant effect on prognosis [8]. Tumor-infiltrating lymphocytes and tumor-infiltrating macrophages are reported to be prognostic factors for survival in patients [8–10]. It has long been known that the initial lymphocyte count has a prognostic role in cHL, and lymphopenia (<600 cells / mm<sup>3</sup> or <8% of leukocytes) is also associated with adverse survival outcome [5, 9]. In this study, it was aimed to reveal the factors affecting prognosis, response and progression in the Hodgkin group and create a new field in terms of scoring at the time of diagnosis by revealing the relationship between lymphocyte count at the time of diagnosis and stage.

The current approach to HL should be a personalized treatment. Many patients with HL can be treated with standard therapy and therefore they are at risk of potential long-term complications. The factors that determine patients with a low or high risk of relapse will therefore be most useful in optimising treatment based on the patient's expected clinical outcome to avoid over-treatment of some patients and under-treatment of others. Prognostic factors for early-stage HL have been identified and include the presence of a large mediastinal mass, an increased sedimentation rate, involvement of multiple nodal sites, extranodal involvement, age of 50 years, or massive splenic disease [11]. A different prognostic scoring system has been developed for advanced stage HL by the International Prognostic Factor Project [2]. As a result of this study, seven variables were defined: being over 45 years of age,

presence of stage IV disease, being male, leukocyte count  $\geq 15,000$ , lymphocyte count <600, albumin <4,0 g / dL and hemoglobin <10,5 g / dL. The 5-year PFS is 42% in patients with five or more factors, while the 5-year PFS is 84% in patients without negative prognostic factors.

**Keywords:** Hodgkin lymphoma, lymphocyte, stage, prognosis

## **References**

1. Amraee, A., Evazi, M. R., Shakeri, M., Roozbeh, N., Ghazanfarpour, M., Ghorbani, M., Ansari, J., & Darvish, L. (2019). Efficacy of nivolumab as checkpoint inhibitor drug on survival rate of patients with relapsed/refractory classical Hodgkin lymphoma: a meta-analysis of prospective clinical study. *Clinical & translational oncology : official publication of the Federation of Spanish Oncology Societies and of the National Cancer Institute of Mexico*, 21(8), 1093–1103.
2. Hasenclever, D., & Diehl, V. (1998). A prognostic score for advanced Hodgkin's disease. International Prognostic Factors Project on Advanced Hodgkin's Disease. *The New England journal of medicine*, 339(21), 1506–1514.

**4TH INTERNATIONAL LATIN AMERICAN  
CONGRESS ON NATURAL AND APPLIED SCIENCES**

3. Koh, Y. W., Kang, H. J., Park, C., Yoon, D. H., Kim, S., Suh, C., Kim, J. E., Kim, C. W., & Huh, J. (2012). Prognostic significance of the ratio of absolute neutrophil count to absolute lymphocyte count in classic Hodgkin lymphoma. *American journal of clinical pathology*, 138(6), 846–854.
4. Seshadri, T., Pintilie, M., Keating, A., Crump, M., & Kuruvilla, J. (2008). The relationship between absolute lymphocyte count with PFS in patients with Hodgkin's lymphoma undergoing autologous hematopoietic cell transplant. *Bone marrow transplantation*, 42(1), 29–34.
5. Tadmor, T., Bari, A., Marcheselli, L., Sacchi, S., Aviv, A., Baldini, L., Gobbi, P. G., Pozzi, S., Ferri, P., Cox, M. C., Cascavilla, N., Iannitto, E., Federico, M., & Polliack, A. (2015). Absolute Monocyte Count and Lymphocyte-Monocyte Ratio Predict Outcome in Nodular Sclerosis Hodgkin Lymphoma: Evaluation Based on Data From 1450 Patients. *Mayo Clinic proceedings*, 90(6), 756–764.
6. Quail, D. F., & Joyce, J. A. (2013). Microenvironmental regulation of tumor progression and metastasis. *Nature medicine*, 19(11), 1423–1437.
7. Troppan, K., Deutsch, A., Gerger, A., Stojakovic, T., Beham-Schmid, C., Wenzl, K., Neumeister, P., & Pichler, M. (2014). The derived neutrophil to lymphocyte ratio is an independent prognostic factor in patients with diffuse large B-cell lymphoma. *British journal of cancer*, 110(2), 369–374.
8. Steidl, C., Lee, T., Shah, S. P., Farinha, P., Han, G., Nayar, T., Delaney, A., Jones, S. J., Iqbal, J., Weisenburger, D. D., Bast, M. A., Rosenwald, A., Muller-Hermelink, H. K., Rimsza, L. M., Campo, E., Delabie, J., Braziel, R. M., Cook, J. R., Tubbs, R. R., Jaffe, E. S., ... Gascoyne, R. D. (2010). Tumor-associated macrophages and survival in classic Hodgkin's lymphoma. *The New England journal of medicine*, 362(10), 875–885.
9. Schreck, S., Friebel, D., Buettner, M., Distel, L., Grabenbauer, G., Young, L. S., & Niedobitek, G. (2009). Prognostic impact of tumour-infiltrating Th2 and regulatory T cells in classical Hodgkin lymphoma. *Hematological oncology*, 27(1), 31–39.
10. Koh, Y. W., Kang, H. J., Park, C., Yoon, D. H., Kim, S., Suh, C., Kim, J. E., Kim, C. W., & Huh, J. (2012). Prognostic significance of the ratio of absolute neutrophil count to absolute lymphocyte count in classic Hodgkin lymphoma. *American journal of clinical pathology*, 138(6), 846–854.
11. Ansell S. M. (2020). Hodgkin lymphoma: A 2020 update on diagnosis, risk-stratification, and management. *American journal of hematology*, 95(8), 978–989.

**COMPARATIVE ANALYSIS OF NEW OPPORTUNITIES FOR  
PHARMACOTHERAPY OF NON-SPECIFIC  
ULCERATIVE COLITIS AND WAYS TO IMPROVE ITS PERFORMANCE  
EVALUATION**

**P.H. Najafgulieva**

**R.Sh.Qasimov**

Azerbaijan Medical University, Baku, Azerbaijan

**ABSTRACT**

The aim of our study was to improve outcomes by improving complex therapy in patients with non-specific ulcerative colitis.

**Materials and methods:** From 2008 to 2022, there were 261 patients diagnosed with non-specific ulcerative colitis under our control, of whom 171 were women and 90 were men. The age of the patients ranged from 16 to 68. 58 patients had total colitis, 84 patients had left-sided lesions, 119 patients had proctitis and proctosigmoiditis. In the complex treatment of these patients, anti-inflammatory drugs - aminosalicylates - sulfasalazine or salofalk, corticosteroids; immunodepressants were used. Salofalk was used as a suppository during proctitis, as a microenema in left-sided lesions, and in general form as a tablet. Metipred was used during complex therapy as a corticosteroid. Hydrocortisone is prescribed in the form of rectal drops or microenemas in the case of distal localized lesions and I-II degree lesions. 6-mercaptopurine and azathioprine were mainly used in the complex therapy of immunodepressants. Elimination of the acute phase and remission was achieved in the majority of patients who received this treatment regimen. In 11 patients with left-sided ulcerative colitis, emergency surgery, subtotal resection of the colon and colostomy were performed due to perforation of the large intestine. From 6 months to 2 years after surgery, the preserved part of the large intestine was rehabilitated with candles and microenemas, topical mesalazine, metronidazole, and hormones such as intestinal antiseptics. Then, in the second stage of the operation, an operation to restore intestinal permeability was performed with the cancellation of the colostomy. Acute toxic dilatation was observed in 13 patients with left-sided ulcerative colitis. In 7 patients with toxic dilatation, the condition was stabilized with conservative therapy, and in the other 6 patients, because conservative therapy did not work, surgery was performed - subtotal resection of the large intestine, ileostomy was performed. Hormones, local mesalazine, metronidazole, suppositories and intestinal antiseptics in the form of microenemas were injected into the preserved part of the large intestine in these patients between 6 months and 2 years after the operation. Then, in the second stage of the operation, an operation to restore intestinal permeability was performed by canceling the ileostomy. In 6 patients with total colitis, conservative treatment did not work, stools were bloody and mucous 14-16 times a day, the disease was aggravated by pseudopolyposis, radical surgery was performed. From 6 months to 2 years postoperatively, patients were treated conservatively, mainly with hydrocortisone as rectal drops and microenemas, according to the above effect. As a result, the process in the rectum was completely canceled and the patients underwent an operation to restore intestinal permeability by closing the ileostomy. Against the background of treatment, favorable results were obtained in 100% of patients with proctitis.

**4TH INTERNATIONAL LATIN AMERICAN  
CONGRESS ON NATURAL AND APPLIED SCIENCES**

**Conclusion:** According to our observations, complex therapy with anti-inflammatory aminosalicylates sulfasalazine or salofalk, corticosteroids and immunodepressants in patients with non-specific ulcerative colitis was a favorable method that led to rapid activation of patients, quick elimination of the acute period, early discharge from the hospital and a significant reduction of relapses, complications and during the surgery performed on time allows patients to get a positive result. Positive results are achieved in 70-80% of cases after the operation. Annual preventive examination is recommended.

**Key words:** ulcerative colitis, toxic dilatation, surgical treatment



**4TH INTERNATIONAL LATIN AMERICAN  
CONGRESS ON NATURAL AND APPLIED SCIENCES**

**USE OF OILSEEDS BY-PRODUCTS IN AQUA-FEEDS**

**Dr. Syed Makhdoom Hussain**

Fish Nutrition Laboratory, Department of Zoology, Government College University,  
Faisalabad.

**ABSTRACT**

In the current talk will discuss about the use of conventional and non-conventional plant by-products in aqua-feeds to promote the sustainable production of multiple fish species in aquaculture. The development of sustainable protein sources to substitute fish meal in aqua-feeds is critical to the continued growth and intensification of aquaculture productivity. Fish feed plays an important role in the growth of the aquaculture industry. Fishmeal (FM) has been employed as the principal protein element in aquaculture because of its beneficial essential amino acids, high digestibility, and palatability. Fishmeal prices are expected to rise by 20% between now and 2030 because of rising demand and increased output. This requires the search for better FM alternatives for long term aqua-feed production. In this light, much efforts have been conducted to seek the sustainable supplies of protein sources to substitute FM. Good nutrition in production systems is essential to economically produce a healthy, high product the first consideration for formulation of feed is the quality of the feed ingredients. Use of plant protein source in the feed industry has been in practice for various advantages such as sustainability, availability, cost effectiveness etc. Because of their high protein content, excellent amino acid profile, low cost, and year-round availability, they are commonly utilized as a cost-effective alternative to high-quality fish meal in diets for many aquaculture fish species. *Moringa oleifera* leaf meal, *Moringa oleifera* seed meal, Canola meal, Sunflower meal, and Cottonseed meal have all been studied extensively. Different supplements, such as enzymes, probiotics, organic acids, and Nano-particles, are also given to fish meals in addition to plant by-products. All of these factors help fish species enhance their growth, nutrient digestibility, and body composition.

**Keywords:** plant by-products, replacement, feed formulation, cost effective, environment friendly

**4TH INTERNATIONAL LATIN AMERICAN  
CONGRESS ON NATURAL AND APPLIED SCIENCES**

**IMPACT OF HEAVY METALS CONTENT FOUND IN IRRIGATED RED PEPPER  
IN CHALLAWA INDUSTRIAL AREA**

**Aminu Ado Kaugama**

**Mahrazu A. Yusuf Phd**

**Ushie Onumashi Afi Phd**

**Yusha'u Safiyanu Muhammad**

**Ansar Bilyamin Adam**

**Jabir Abdullahi Muhammad**

Department of Geography and Resources Development Federal University Wukari

Department of Geography Bayaro University Kano

Department of Chemical Science Federal University Wukari

Department of Chemistry Kano University of Science and Technology Wudil

Department of Chemistry Sa'adatu Rimi College of Education Kumbotso, Kano

**ABSTRACT**

Wastewater from Challawa industrial area were used for irrigation purpose, red pepper were sample and used to determine the presence of heavy metal content and their concentrations in the sample. The sample were collected and prepared using standard analytical procedures. The concentration of red pepper was determined using atomic absorption Spectroscopy (AAS). The mean concentration ug/g obtained from the analysis was found to be pb 12.82, Cd 2.02, Cu 2.99, Zn 3.67 and Cr 7.96. The results indicated that significant amount of Pb, Cd and Cr are beyond permissible limit whereas Cu and Zn concentration are within the permissible limit. There is health risk in taking excess amount of those heavy metals in higher concentration above permissible limit.

**Keywords:** Red pepper, AAS, Heavy metal, Waste water, Permissible limit.

**4TH INTERNATIONAL LATIN AMERICAN  
CONGRESS ON NATURAL AND APPLIED SCIENCES**

**PREPARATION AND EVALUATION OF TOPICAL PREPARATION OF  
EULALIOPSIS BINATA EXTRACT**

**Jyoti Sinha**

**Vinod Kumar**

Department of Pharmacy, School of health Sciences, Sushant University, Grurugram Sec 55,  
Haryana, India;

**Corresponding Author:** Dr Vinod Kumar, Department of Pharmacy, School of Health  
Sciences, Sushant University, Grurugram Sec 55, Haryana, India;

**ABSTRACT**

Now a days, human race suffer from number of health problems like respiratory obstruction, arthritis, heart disease, stroke, diabetes etc. and the major cause of all diseases is the poor diet, lack of exercise and formation of free radical etc. However by improving the life style can easily get rid from majority of diseases for example use of antioxidant in diet can easily avoid the formation of free radicals and Reactive oxygen species (ROS) that are able to bind with almost all cell/tissue, causing damage that result in various degenerative diseases. Scientific study revealed that the plant are the rich source of antioxidants and human race used plants since time immemorial to treat illness. *Eulaliopsis binata* (sabai grass or Chinese alpine rush), is a perennial plant belonging to the grass family that is grown in many Asian countries and most commonly used to make rope, feeder material for plants etc in India, but apart from this it also possess the antimicrobial, anti-inflammatory and wound healing activities. For its better pharmacological effect homogeneous, semi-solid or viscous preparations that possess a relatively fluid consistency and are intended for external application to the skin. Research stated that the topical preparation gain attention of researchers, from the past few decades. In this study we prepared the cream of aqueous extract from the leaf of *Eulaliopsis binata* and evaluate its different analyzing parameters.

**Key Words:** Eulaliopsis binate, Topical preparation, Cream, Antimicrobial, Antioxidants

**NOVEL CRYOPROTECTANTS AND THEIR EFFECTS ON DECREASING  
GLYCEROL CONCENTRATION DURING CRYOPRESEVATION**

**Kave Koorehpaz**

Urmia University, Faculty of Veterinary Medicine, Department of Theriogenology and  
Obstetrics, Urmia, Iran.

ORCID NO: <http://orcid.org/0000-0003-1968-9453>

**ABSTRACT**

Cryoprotectants are extensive supplements that added on extender to reduce ice-crystal formation during freeze-thawing process. In the field of theriogenology and obstetrics, we cryopreserve the sperm to control transmission of various bacterial or viral micro-organisms. On the other hand, cryopreservation is useful to store and transfer high-producer genes in farm animals. Two type of cryoprotectants use in extender including non-permeating and permeating. Permeating cryoprotectants entering the sperm and replacing with intracellular water and thus cellular dehydration occur. Polyethylene glycol, glycerol and DMSO are kind of permeating cryoprotectants that use extremely on sperm cryopreservation in both human and animals. Second type of cryoprotectants are permeating cryoprotectants such as polysaccharides, polyaminoacids and disaccharides that reduce the freezing temperature of extender and thus reduce extracellular ice formation. Novel cryoprotectants that use in field of sperm cryopreservation are carboxymethyl cellulose, trehalose, platelet-rich plasma, polyvinylpyrrolidone and cyclodextrins. Recent studies demonstrated that adding variable concentration of novel cryoprotectants on extender can reduce DNA fragmentation index (DFI), reactive oxygen species (ROS). Furthermore, plasma membrane integrity (PMI) and sperm parameters significantly enhance with adding these novel cryoprotectants. Moreover, some investigations showed that with adding different cryoprotectants before freeze-thawing process in extender simultaneously with glycerol, we can manipulate on exact concentration of glycerol that proved previously on studies. Glycerol have adverse effect on sperm during cryopreservation of sperm and can damage on sperm during freeze-thawing process that named cryoinjury. Some studies proved that when other supplements as carboxymethyl cellulose and trehalose added on extender, we can reduce the concentration of glycerol on extender and replace it with novel non-permeating cryoprotectants. Reduction of glycerol concentration from 6% to 4%(v/v) is suitable for sperm and enhance all sperm parameters such as progressive motility, viability and etc.

**keywords:** Cryoprotectants, cryodamage, extender, sperm.

**4TH INTERNATIONAL LATIN AMERICAN  
CONGRESS ON NATURAL AND APPLIED SCIENCES**

**HYDROXYMETHYL-P-TOLUENESULFONAMIDE AS AN ANTIOXIDANT  
ADDITIVE TO DIESEL FUELS**

**ГИДРОКСИМЕТИЛ-П-ТОЛУОЛСУЛЬФОНАМИД В КАЧЕСТВЕ  
АНТИОКСИДАНТНОЙ ПРИСАДКИ К ДИЗЕЛЬНЫМ ТОПЛИВАМ**

**Novotorzhina Nelya**

Leading Researcher, Associate Professor, Institute of Additive Chemistry, Azerbaijan.  
ORCID NO: <https://orcid.org/0000-0001-6618-7574>,

**Rzayeva Irada**

Leading Researcher, Associate Professor, Institute of Additive Chemistry, Azerbaijan.  
ORCID NO: <https://orcid.org/0000-0001-9169-3268>

**Kazimzadeh Shafa**

Engineer, Institute of Additive Chemistry, Azerbaijan.  
ORCID: <https://orcid.org/0000-0002-3016-9849>

**Safarova Mehpara**

Chief Researcher, Institute of Additive Chemistry, Azerbaijan.  
ORCID: <https://orcid.org/0000-0002-2680-5654>

**Gahramanova Gariba**

Leading Researcher, Associate Professor, Institute of Additive Chemistry, Azerbaijan.  
ORCID NO: <https://orcid.org/0000-0003-4554-9681>

**Mustafayeva Yegana**

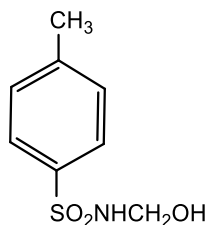
Engineer, Institute of Additive Chemistry, Azerbaijan.  
ORCID: <https://orcid.org/0000-0001-7004-6299>

**АННОТАЦИЯ**

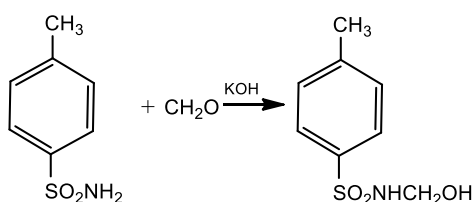
В связи с развитием машиностроения потребность в антиокислительных присадках к топливам растет из года в год, это связано с тем, что при неполном сгорании топлив в моторах и двигателях в процессе их эксплуатации ухудшается коэффициент полезного действия, что приводит к образованию осадков, забивающих топливные фильтры и форсунки двигателей.



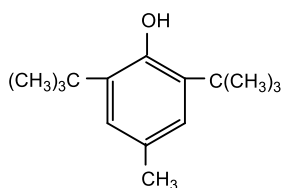
Авторы данной работы предложили новое соединение гидроксиметил-п-толуолсульфонамид в качестве антиокислительной присадки к дизельным топливам, формулы:



Соединение получено взаимодействием п-толуолсульфонамида с параформом в щелочной среде по нижеследующей схеме:



Исследование антиокислительных свойств, проводились в сравнении известной антиокислительной присадки ионол, формулы:



Результаты исследования показали, что антиокислительные свойства гидроксиметил-п-толуолсульфонамида значительно превосходят антиокислительные свойства ионола. Это можно объяснить наличием в синтезированном соединении гидроксильных, амидных и ароматических групп.

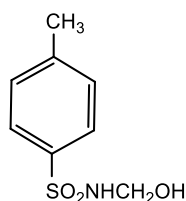
Гидроксиметил-п-толуолсульфонамид может быть рекомендован в качестве антиокислительной присадки к дизельным топливам.

**Ключевые слова:** антиокислительные присадки, толуолсульфонамид, дизельное топливо

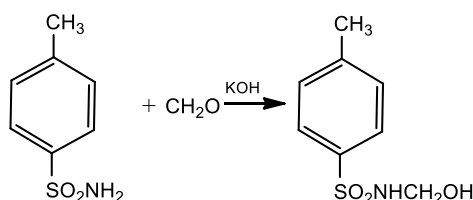
## ABSTRACT

In connection with the development of the engineering industry, the demand for antioxidant additives to fuels is growing from year to year, this is due to the fact that with incomplete combustion of fuels in motors and engines during their operation, the efficiency deteriorates, which leads to the formation of precipitation that clogs the fuel filters and nozzles of engines.

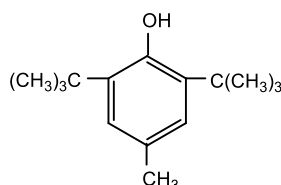
The authors of this work proposed a new compound, hydroxymethyl-p-toluenesulfonamide, as an antioxidant additive to diesel fuels, with the formula:



The compound was obtained by the interaction of p-toluenesulfonamide with paraform in an alkaline medium according to the following scheme:



The study of antioxidant properties was carried out by comparing the known antioxidant additive ionol, formula:



The results of the study showed that the antioxidant properties of hydroxymethyl-p-toluenesulfonamide are much superior to the antioxidant properties of ionol. This can be explained by the presence of hydroxyl, amide, and aromatic groups in the synthesized compound.

Hydroxymethyl-p-toluenesulfonamide can be recommended as an antioxidant additive for fuels.

**Keywords:** antioxidant additives, toluenesulfonamides, diesel fuel

**4TH INTERNATIONAL LATIN AMERICAN  
CONGRESS ON NATURAL AND APPLIED SCIENCES**

**DETERMINATION OF THE INFLUENCE OF STRUCTURE, SIZE OF WORKING  
NESTS AND THEIR FORAGING ON THE DEVELOPMENT OF FIELD MOUSE IN  
SOWN AREAS**

ƏKİN SAHƏLƏRİNDƏ İŞLƏK YUVALARIN QURLUŞUNUN, ÖLÇÜLƏRİNİN,  
ONLARIN QIDA YIĞIMININ ÇÖL SIÇANLARININ İNKİŞAFINA TƏSİRİNİN  
MÜƏYYƏN EDİLMƏSİ

ОПРЕДЕЛЕНИЕ ВЛИЯНИЯ СТРОЕНИЯ, РАЗМЕРОВ РАБОЧИХ ГНЕЗД И ИХ  
КОРМОВОГО СБОРА НА РАЗВИТИЕ ПОЛЕВОЙ МЫШИ НА ПОСЕВНЫХ  
ПЛОЩАДЯХ

**Associate Professor Allakhverdiyev Elkhan Rajaf**  
Azerbaijan State Agrarian University

**D. student, Abbasova Nahida Shavaat**  
Azerbaijan State Agrarian University

**XÜLASƏ**

Kənd təsərrüfatı bitkilərinə daha çox zərər vuran zərərvericilərdən biri də gəmiricilərin əsas nümayəndələrindən olan adi çöl siçanıdır (*Misrotus socialis pall*). Azərbaycan faunasının tərkibində 8 fəsilə və 19 cinsə daxil olan 37 növ gəmirici yayılmışdır. Çöl siçanlarına qarşı mübarizə tədbirlərinin hazırlanmasında işlək yuvaların quruluşunun, ölçülərinin, onların sayının öyrənilməsinin böyük əhəmiyyəti vardır. Məqalədə bunlarla yanaşı yuvalarda qida yığımının və digər göstəricilərin çöl siçanlarının inkişafına təsiri şərh edilmişdir.

İlk dəfə olaraq Azərbaycanın Mil-Qarabağ bölgəsində 2021-2022-ci illərdə müxtəlif əkin sahələrində çöl siçanlarının inkişafına təsir edən amillərdən asılı olaraq yuvaların ölçüləri (eni və hündürlüyü) və yuvalarda toplanmış yem ehtiyatının mühüm əhəmiyyətinin olması müəyyən edilmişdir. Eyni zamanda tədqiqatlar zamanı çöl siçanlarının yuvalarının dərinliyi ilin mövsümləri üzrə dəyişməsidə müəyyən edilmişdir.

Müşahidələrdən və ölçmələrdən məlum olur ki, çöl siçanlarının yuvalarının dərinliyi müxtəlif olur. Ən dayaz yuvaların dərinliyi 5-10 sm-ə qədər, buğda, arpa əkin sahələrində şumlamadan asılı olaraq 20-25 sm, nadir hallarda isə daha dərin olmuşdur.

Tədqiqatlar zamanı işlək yuvaların eni və hündürlüklərin nisbətən böyük olması həmin yuvalarda daha çox miqdarda yem ehtiyatının olmasına təsadüf edilmişdir. Qeyid etmək lazımdır ki, işlək yuvaların ölçülərinin dəyişməsinə müvafiq olaraq daha çox yem ehtiyatına əsasən payız mövsümündə rast gəlinmişdir. Beləki, taxıl əkinlərində payızda işlək yuvalarda yem ehtiyatının miqdarı 236,3-250,4 qram, yonca sahələrində 241,3-258,4 qram, meyvə və üzümlüklərdə isə daha çox 243,2-264,3 qrama bərabər olmuşdur.

Tədqiqatlardan belə nəticəyə gəlmək mümkündür ki, işlək yuvaların ölçülərinin böyüklüyü çöl siçanlarının bu yuvalarda xüsusilə də meyvə və üzümünlüklərdə təsadüf edilən işlək yuvalada daha çox miqdarda yem ehtiyatının toplanmaları üçün əlverişli olmuşdur. Bu isə işlək yuvaların ölçülərinin böyüklüyü və yuvalarda yem ehtiyatının bolluğunun çöl siçanlarının bu yuvalarda artıb çoxalmaları üçün əlverişli şəraitin olması zəruriyyətini yaradır.

**Açar sözlər:** əkin sahələri, çöl siçanları, yuvaların quruluşu, gəmiricilər

## **АБСТРАКТНЫЙ**

Полевая мышь (*Misrotus socialis pall*), один из основных представителей грызунов, является одним из вредителей, наносящих наибольший ущерб сельскохозяйственным культурам. Животный мир Азербайджана включает 37 видов грызунов, принадлежащих к 8 семействам и 19 родам. Изучение строения, размеров и количества функциональных гнезд имеет большое значение при подготовке мероприятий по борьбе с полевыми мышами. Кроме них, в статье описано влияние сбора пищи в гнездах и других показателей на развитие полевых мышей.

Впервые в Миль-Карабахском районе Азербайджана в 2021-2022 годах было установлено, что размеры гнезд (ширина и высота) и собранный в гнездах кормовой запас имеют значение в зависимости от факторов, влияющих на развитие полевых мышей. В то же время в ходе исследований установлено, что глубина гнезд полевых мышей изменяется в зависимости от времени года.

Из наблюдений и измерений известно, что глубина гнезд полевых мышей неодинакова. Глубина самых мелких гнезд была до 5-10 см, 20-25 см была в зависимости от вспашки на пшеничном и ячменном полях, редко бывало и глубже.

В ходе исследований было выявлено, что относительно большая ширина и высота рабочих гнезд совпадали с наличием в них больших запасов корма. Следует отметить, что изменения размеров рабочих гнезд были обнаружены в осенний сезон в зависимости от кормовой базы. Так, количество кормовых запасов в рабочих гнездах осенью на зерновых культурах составило 236,3-250,4 грамма, на полях люцерны - 241,3-258,4 грамма, а на плодовых и виноградниках - 243,2-264,3 грамма.

Из исследований можно сделать вывод, что размер рабочих гнезд был благоприятным для того, чтобы полевые мыши собирали в этих гнездах больше запасов пищи, особенно в рабочих гнездах, обнаруженных во фруктовых и виноградных садах. Это приводит к благоприятным условиям для роста и размножения полевых мышей в этих гнездах из-за больших размеров рабочих гнезд и обилии кормовой базы в гнездах.

**Ключевые слова:** посевные площади, полевые мыши, устройство гнезд, грызуны.

**4TH INTERNATIONAL LATIN AMERICAN  
CONGRESS ON NATURAL AND APPLIED SCIENCES**

**ABSTRACT**

The field mouse (*Misrotus socialis pall*), one of the main representatives of rodents, is one of the most damaging pests to crops. The animal world of Azerbaijan includes 37 species of rodents belonging to 8 families and 19 genera. The study of the structure, size and number of functional nests is very important for the preparation of measures to control field mice. In addition to these, the paper describes the effect of nest collection and other indicators on the development of field mice.

For the first time in the Mil-Karabakh region of Azerbaijan in 2021-2022, the size of nests (width and height) and the amount of food collected in the nests were found to be relevant to the factors influencing the development of field mice. At the same time, studies have found that the depth of field mouse nests varies with the time of year.

From observations and measurements, we know that the depth of field mouse nests varies. The depth of the shallowest nests was up to 5-10 cm, 20-25 cm depending on ploughing in wheat and barley fields, rarely deeper.

Studies showed that the relatively large width and height of the working nests coincided with the presence of large fodder reserves in the nests. It should be noted that variation in working nest size was found during the autumn season depending on the food availability. For example, the number of forage nests in autumn in grain crops was 236.3-250.4 grams, in alfalfa fields, 241.3-258.4 grams, and in fruit and vineyards, 243.2-264.3 grams.

We may conclude from the research that the size of the worker nests was favourable for field mice to collect more food reserves in these nests, especially in the worker nests found in orchards and vineyards. This leads to favourable conditions for the growth and reproduction of field mice in these nests due to the large size of the working nests and the abundance of food in the nests.

**Key words:** sowing area, field mouse, nesting, rodents.

**GROWTH VARIATION IN FOREST TREE SPECIES IN AFFORESTATION OF  
GRADONI TERRACING**

**Nilüfer YAZICI**

Ass. Prof., Isparta University of Applied Sciences

ORCID NO: 0000-0002-4397-5639

**Nebi BİLİR**

Professor, Isparta University of Applied Sciences

ORCID NO: 0000-0001-9911-4304

**ABSTRACT**

The study was carried out to contribute forestry practices in an afforestation area established by gradoni terracing of Taurus cedar also called Cedar of Lebanon (*Cedrus libani* A.Rich.), Anatolian black pine [*Pinus nigra* Arnold. subsp. *pallasiana* (Lamb.) Holmboe] and Crimean juniper (*Juniperus excelsa* M. Bieb. *excelsa*) in southern part of Turkiye in 2007. The species *C. libani* (0.4 million ha), *P. nigra* (4.3) and *J. excelsa* (1.5) occupy at 6.2 million ha which of 26.8% total forest area of Turkiye. However, 42% of total forest area of Turkiye is unproductive or also called degraded forest. It was 25% in *C. libani*, 33% in *P. nigra* and 73% in *J. excelsa*. Afforestation practices included many stages is main tool in conversion of degraded forest to productive forest.

Tree height and diameter at base were measured in thirty individuals chosen randomly in each species at end of growth period of 2022. The species were compared by linear model of analysis of variance for the characteristics. Tree height and diameter at base were related by correlation analysis for each species.

Anatolian black pine had the highest diameter at base (11.96 cm), while tree height was the highest in Taurus cedar (3.55 m). There were also large differences among individuals within species for the characteristics. Individual tree heights were ranged from 1.95 m to 5.50 m in *C. libani*, from 1.87 to 4.05 in *P. nigra*, from 1.85 to 3.24 in *J. excelsa*, while, diameter at base varied between 1.95 and 5.20 cm in *C. libani*, between 7.50 and 15.38 cm in *P. nigra*, and between 6.08 and 11.38 cm in *J. excelsa* for individual trees.



**4TH INTERNATIONAL LATIN AMERICAN  
CONGRESS ON NATURAL AND APPLIED SCIENCES**

Species showed significant ( $p \leq 0.01$ ) differences for tree height and diameter at base according to results of analysis of variance. There were positive and significant ( $p \leq 0.05$ ) relations between the characteristics in all the species. According to results of correlation analysis phenotypic correlation coefficients ( $r_p$ ) were 0.919 in *C. libani*, 0.618 in *P. nigra* and 0.507 in *J. excels*.

Results of the study were discussed based on plantation forestry and other forestry practices in the species.

**Keywords:** Growth, Plantation, Silviculture, Seedling, Variation.

**EFFECT OF TERRACING ON GROWTH OF TAURUS CEDAR (*CEDRUS LIBANI*):  
A CASE STUDY FROM ISPARTA DISTRICT**

**Nilüfer YAZICI**

Ass. Prof., Isparta University of Applied Sciences

ORCID NO: 0000-0002-4397-5639

**Nebi BİLİR**

Professor, Isparta University of Applied Sciences

ORCID NO: 0000-0001-9911-4304

**ABSTRACT**

Taurus cedar (*Cedrus libani* A. Rich.) is a key species used in Turkish plantation forestry widely. Soil treatment also known soil preparation has play important role in biological and economical success of the plantation forestry together with other biotic and a-biotic factors such as climatic, edaphic and geographic characteristics.

In this case study, growth performances of Taurus cedar were compared between soil preparation by terracing and control treatment (mean un-preparation) based on tree height and diameter at base of sampled 35 trees of each treatment in plantation areas established at Isparta district from southern part of Turkiye in 2008.

Terracing preparation had higher tree height (211.6 cm) to control (178.9 cm) opposite to diameter at base (6.46 cm and 7.73 cm), while individual trees showed large difference for the characteristics within treatment. Tree height had higher variation than diameter in both treatments.

The treatments showed similar ( $p>0.05$ ) growth performances for the characteristics performed by analysis of variance. Positive and significant ( $p\leq 0.01$ ) phenotypic relations ( $r$ ) between tree height and diameter at base in terracing ( $r=.699$ ) and control ( $r=.559$ ) treatments, and also pooled treatments ( $r=.314$ ).

Present case study was carried out by one year data and limited area. New studies should be carried out by different characteristics such as survival, diameter at breast height, and locations to give accurate conclusions.

**Keywords:** Diameter, Forest, Height, Soil, Survival.

## **INTRODUCTION**

Taurus cedar also known Cedar of Lebanon (*Cedrus libani* A. Rich.) is used plantation forestry widely (Ayan *et al.*, 2017) because of social-cultural importance and commercial wood product of the species, although limited natural distribution (0.4 million ha) in Taurus mountains at southern Turkiye (OGM, 2022). Many biotic and a-biotic factors such as climatic, edaphic and geographic characteristics and treatments such as soil treatment/soil preparation or its different methods, watering, fertilization could play important roles in success of the plantation forestry practices.

In this case study, plantation areas prepared by terracing and control (mean un-preparation in the paper) were compared by tree height and diameter at base to contribute plantation forestry of the species.

## **MATERIAL AND METHODS**

Two plantation areas of Taurus cedar were sampled soil preparation by terracing and control (mean un-preparation) treatments established at Isparta district from southern part of Turkiye in 2008 (Table 1, Figure 1). The plantations were close to each other. We assumed climatic and epahic conditions, provenance of the seedlings, seedling type and planting foresters were similar in the areas.

**Table 1.** Some details of the plantation areas.

<b>Treatments</b>	<b>Latitude (N)</b>	<b>Longitude (E)</b>	<b>Altitude (m)</b>	<b>Slope (%)</b>	<b>Aspect</b>	<b>Spacing (m)</b>
<b>Terracing</b>	37°51'647"	30°29'2932"	1122	25-30	<b>West</b>	3x1.5
<b>Control</b>	37°51'818"	30°28'792"	1062	30-35	<b>South</b>	2x1.5



**Fig. 1.** Terracing (left side) and control areas.

Growth data (Tree height-**TH** and diameter at base-**D<sub>0</sub>**) was collected from 35 individual trees sampled randomly from each treatment at end of growth period of 2022.

The treatments were compared for the tree height and diameter at base by following linear ANOVA model at SPSS (SPSS, 2011):

$$Y_{ij} = \mu + P_j + e_{ij} \quad (1)$$

Where  $Y_{ij}$  is the observation from the  $j^{th}$  tree of the  $i^{th}$  treatment,  $\mu$  is overall mean,  $P_i$  is the random effect of the  $i^{th}$  treatment, and  $e_{ij}$  is random error.

Tree height and diameter at base was related by Pearson's phenotypic correlation analysis at SPSS (SPSS, 2011).

## RESULTS AND DISCUSSION

Terracing preparation had higher tree height (211.6 cm) performance than control treatment (178.9 cm), while control treatment (7.73 cm) showed higher diameter at base performance than terracing treatment (6.46 cm) (Table 2, Figure 2). It could be said that annual increments were 0.15 m for TH and 0.0046 m for  $D_0$  in terracing, while they were 0.12 m and 0.0046 m in control, respectively (Table 2). Averages of tree height and diameter at base were found 9.0 m and 0.27 m in 30 years plantation of the species at southern Turkiye (Kartal and Bilir, 2022). They were reported 3.55 m and 9.05 cm in 15 years plantations established by terracing by Yazıcı and Bilir (2023). Averages of tree height and diameter at base were reported 2.01 m and 0.32 m in 9 years common plantation of the species (Bilir, 2004). However there could be many biotic and a-biotic factors such as climatic, edaphic and geographic characteristics could be effective on the performances. For instance, significant

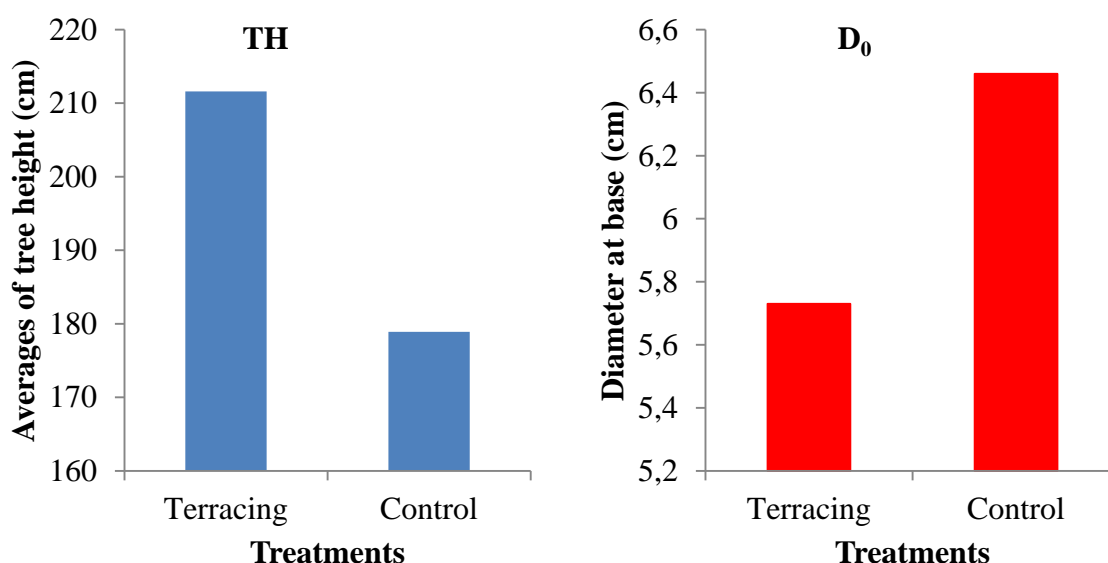
**4TH INTERNATIONAL LATIN AMERICAN  
CONGRESS ON NATURAL AND APPLIED SCIENCES**

effect of soil preparation or soil properties on growth performance of afforestation practices was reported by Göl and Yel (2016) and Yazıcı and Turan (2016). The results emphasized importance of location and plantation practices, and evaluation of age of plantations. Averages of tree height and diameter at base were found 43 cm, 116 cm and 201 cm for tree height; 10.7 mm, 22.0 mm and 32.3 mm for diameter at base in a plantation of the species at 3, 6 and 9 years (Bilir, 2004). Boydak (1996) emphasized importance of age in growth performance of the species.

Tree height had higher variation than diameter based on coefficient of variation in both treatments. It was found 17.6% for tree height and 11.4% for diameter at base for pooled treatments (Table 2). The result could be used in forestry practices such as forest tending in the species.

**Table 2.** Averages, ranges and coefficient of variation (CV) for the characteristics.

	Terracing		Control		Total	
	TH (cm)	D <sub>0</sub> (cm)	TH (cm)	D <sub>0</sub> (cm)	TH (cm)	D <sub>0</sub> (cm)
Averages	211.6	5.73	178.9	6.46	195.3	6.09
Ranges	135-310	3.90-7.45	135-245	4.47-8.34	135-310	3.90-8.34
CV%	14.8	11.4	16.0	15.2	17.6	11.4



**Fig. 2.** Averages of the characteristics.

Individual growth performances were varied between 135 cm and 310 cm for TH, and between and 3.90 cm and 7.45 cm for D<sub>0</sub> in terracing and ranged from 135 cm to 245 cm for TH, and ranged 4.47 cm to 8.34 cm for D<sub>0</sub> in control (Table 2, Figure 3). It could be a guide for future practices such as forest tending. Similar individual variations were also found for the characteristics in the species (i.e., Bilir, 2004; Özel, 2018; Kartal and Bilir, 2022; Yazıcı



**4TH INTERNATIONAL LATIN AMERICAN  
CONGRESS ON NATURAL AND APPLIED SCIENCES**

and Bilir, 2023). It indicated large genetic diversity in the species, and importance of selection in forestry practices. The results showed importance of seed sources and individuals in seed source for seed harvesting.



**Fig. 3.** Individual height variation in terracing.

Terracing and control showed similar ( $p>0.05$ ) growth performances for the characteristics based on results of analysis of variance (Table 3). However, the case study was carried out by limited data collected from two areas.

**Table 3.** Results of analysis of variance for the characteristics of the species.

<b>Characteristics</b>	<b>Source of variation</b>	<b>df</b>	<b>Mean Square</b>	<b>F</b>	<b>P value</b>
<b>TH</b>	Between Groups	2	34	1011.246	.751
	Within Groups	87	35	1346.371	
	Total	89	69		
<b>D<sub>0</sub></b>	Between Groups	2	34	.590	.617
	Within Groups	87	35	.955	
	Total	89	69		



There were positive and significant ( $p \leq 0.01$ ) phenotypic relations ( $r$ ) between tree height and diameter at base in terracing ( $r = 0.699$ ) and control ( $r = 0.559$ ) (Figure 4). Similar results were also reported in early studies of the species (i.e., Bilir, 2004; Özel, 2018; Ertugrul and Bilir, 2020; Kartal and Bilir, 2022; Yazıcı and Bilir, 2023). The results could be used for future studies in the species.

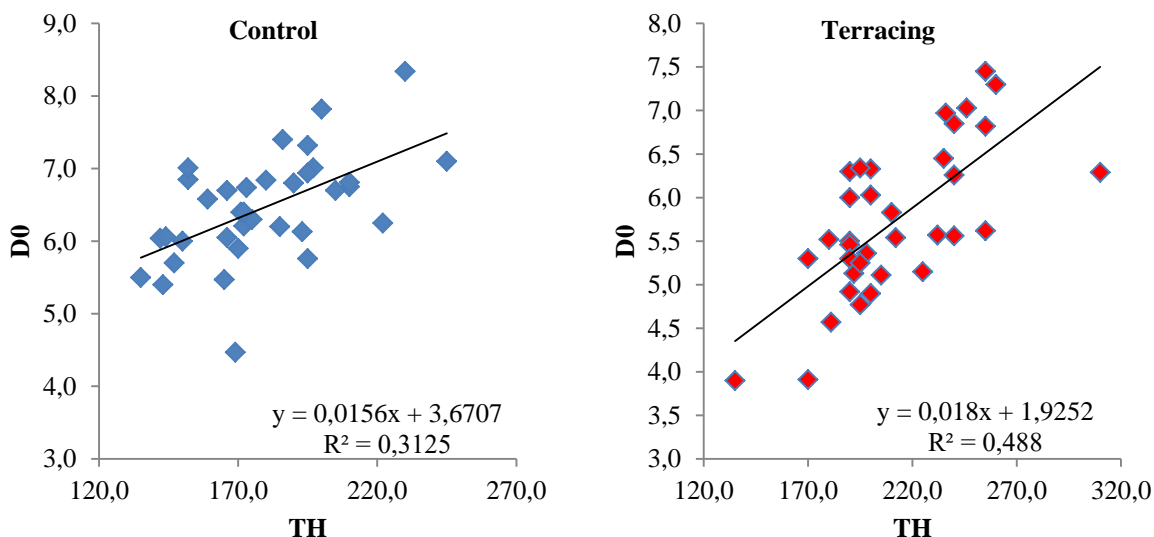


Fig. 4. Relations between tree height and diameter at base in treatments.

## CONCLUSIONS

Results of the study could be used in forestry practices. However, the present case study was carried out by one year data and limited area of Taurus cedar. New studies should be carried out by different characteristics such as survival, number of branches, diameter at breast height, and locations of different species to give accurate conclusions.

## REFERENCES

- Ayan, S., Yer, E.N., Gulseven, O. (2017). Evaluation of Taurus cedar (*Cedrus libani* A. Rich.) afforestation areas in Turkey in terms of climate type. *Journal of Forestry Faculty of Artvin Coruh University*, 18:152-161.
- Bilir, N. (2004). Phenotypic age-age correlations for height, diameter and volume in *Cedrus libani* A. Rich. *Journal of Forestry Faculty of Suleyman Demirel University*, A(1):12-18.
- Boydak, M. (1996). Ecology, silviculture and conservation of Taurus cedar (*Cedrus libani* A. Rich.). Ministry of Forestry press, No:12, Ankara.

**4TH INTERNATIONAL LATIN AMERICAN  
CONGRESS ON NATURAL AND APPLIED SCIENCES**

- Ertuğrul, G.S., Bilir N. (2020). Evaluation on natural regenerations in Kütahya-Simav district of Anatolian black pine. *Artvin Coruh University Journal of Forestry Faculty*, 21(1), 75-81.
- Göl, C., Yel, S. (2016). Assessing the effects of different soil preparation methods on sampling growth in afforestation studies. *Turkish Journal of Forestry*, 17(2): 125-131.
- Kartal, R., Bilir, N. (2022). Evaluation of Ehrami black pine plantations in Isparta district: 30<sup>th</sup> year results. *Bartın University International Journal of Natural and Applied Sciences*, 5:10-17.
- OGM. (2022). Forestry Statistics-2021. [www.ogm.gov.tr](http://www.ogm.gov.tr). Turkiye, Ankara (Date of access: 15.07.2022).
- Özel, S. (2018). Silvicultural evaluation of plantations in Isparta-Yalvaç district. Graduate School of Natural and Applied Science, Suleyman Demirel University, PhD. Thesis, Isparta.
- SPSS. (2011). IBM SPSS Statistics for Windows, Version 20.0., NY: IBM Corp.
- Yazıcı, N., Bilir, N. (2023). Growth variation in forest tree species in afforestation of gradoni terracing. 4<sup>th</sup> Latin American Scientific Research Congresses, Rio de Janeiro, 13-15 March, (in press).
- Yazıcı, N., Turan, A. (2016). Effect of forestry afforestation on some soil properties: A case study from Turkey. *Fresenius Environmental Bulletin*, 25(7): 2509-2513.

**GROWTH VARIATION IN FOREST TREE SPECIES IN AFFORESTATION OF  
GRADONI TERRACING**

**Nilüfer YAZICI**

Ass. Prof., Isparta University of Applied Sciences

ORCID NO: 0000-0002-4397-5639

**Nebi BİLİR**

Professor, Isparta University of Applied Sciences

ORCID NO: 0000-0001-9911-4304

**ABSTRACT**

The study was carried out to contribute forestry practices in an afforestation area established by gradoni terracing of Taurus cedar also called Cedar of Lebanon (*Cedrus libani* A.Rich.), Anatolian black pine [*Pinus nigra* Arnold. subsp. *pallasiana* (Lamb.) Holmboe] and Crimean juniper (*Juniperus excelsa* M. Bieb. *excelsa*) in southern part of Türkiye in 2007. The species *C. libani* (0.4 million ha), *P. nigra* (4.3) and *J. excelsa* (1.5) occupy at 6.2 million ha which of 26.8% total forest area of Türkiye. However, 42% of total forest area of Türkiye is unproductive or also called degraded forest. It was 25% in *C. libani*, 33% in *P. nigra* and 73% in *J. excelsa*. Afforestation practices included many stages is main tool in conversion of degraded forest to productive forest.

Tree height and diameter at base were measured in thirty individuals chosen randomly in each species at end of growth period of 2022. The species were compared by linear model of analysis of variance for the characteristics. Tree height and diameter at base were related by correlation analysis for each species.

Anatolian black pine had the highest diameter at base (11.96 cm), while tree height was the highest in Taurus cedar (3.55 m). There were also large differences among individuals within species for the characteristics. Individual tree heights were ranged from 1.95 m to 5.50 m in *C. libani*, from 1.87 to 4.05 in *P. nigra*, from 1.85 to 3.24 in *J. excelsa*, while, diameter at base varied between 1.95 and 5.20 cm in *C. libani*, between 7.50 and 15.38 cm in *P. nigra*, and between 6.08 and 11.38 cm in *J. excelsa* for individual trees.

Species showed significant ( $p \leq 0.01$ ) differences for tree height and diameter at base according to results of analysis of variance. There were positive and significant ( $p \leq 0.05$ ) relations between the characteristics in all the species. According to results of correlation analysis phenotypic correlation coefficients ( $r_p$ ) were 0.919 in *C. libani*, 0.618 in *P. nigra* and 0.507 in *J. excelsa*.

**4TH INTERNATIONAL LATIN AMERICAN  
CONGRESS ON NATURAL AND APPLIED SCIENCES**

Results of the study were discussed based on plantation forestry and other forestry practices in the species.

**Keywords:** Growth, Plantation, Silviculture, Seedling, Variation.

## INTRODUCTION

Taurus cedar also called Cedar of Lebanon (*Cedrus libani* A.Rich.), Anatolian black pine [*Pinus nigra* Arnold. subsp. *pallasiana* (Lamb.) Holmboe] and Crimean juniper (*Juniperus excelsa* M. Bieb. *excelsa*) are important forest tree species because of their large natural distributions in different ecological conditions. They cover 26.8% total forest area which is 23.1 million ha of Turkey. However, about 42% of the species and Turkey are degraded/unproductive forest area (Table 1, OGM, 2022).

**Table 1.** Forest area of the species and Turkey

Species	Productive (ha)	Degraded (ha)	Total (million ha)
<i>C. libani</i>	0.3 (75%)	0.1 (25%)	0.4
<i>P. nigra</i>	2.9 (67%)	1.4 (33%)	4.3
<i>J. excelsa</i>	0.4 (27%)	1.1 (73%)	1.5
Turkey	13.5 (52%)	9.6 (42%)	23.1

Afforestation practices are main tools in conversion of degraded forest to productive forest. The practices are many stages from seed collection, seedling production, planting, soil preparation to forest tending. Soil preparation has play important role in successful afforestation. For instance, Göl and Yel (2016) indicated importance of soil preparation method in Anatolian black pine plantation. Gradoni terracing is one of the soil preparation methods in afforestation practices. It could be also seen as an environmental factor in the practices. In this study, growth variation in three tree species in an afforestation established by gradoni terracing were examined based on tree height and diameter at base to contribute afforestation and other forestry practices of the species.

## MATERIAL AND METHODS

Tree height (TH), diameter at base ( $D_0$ ) data was collected from a afforestation area (37°52'930" N latitude, 30°30'157" E Longitude, 968 m asl.) established by gradoni terracing soil preparing method in southern part of Turkey in 2007 (Figure 1).



**Fig. 1.** Studied afforestation area

Thirty individuals of Taurus cedar, Anatolian black pine and Crimean juniper were sampled randomly from each species at the same area to collect tree height (**TH**) and diameter at base (**D<sub>0</sub>**) data at end of growth period of 2022.

Collected data was performed by one-way analysis of variance to compare the species for the characteristics at SPSS (SPSS, 2011).

Phenotypic correlations ( $r_p$ ) between tree height (TH) and diameter at base in the species were estimated by (Falconer (1989)).

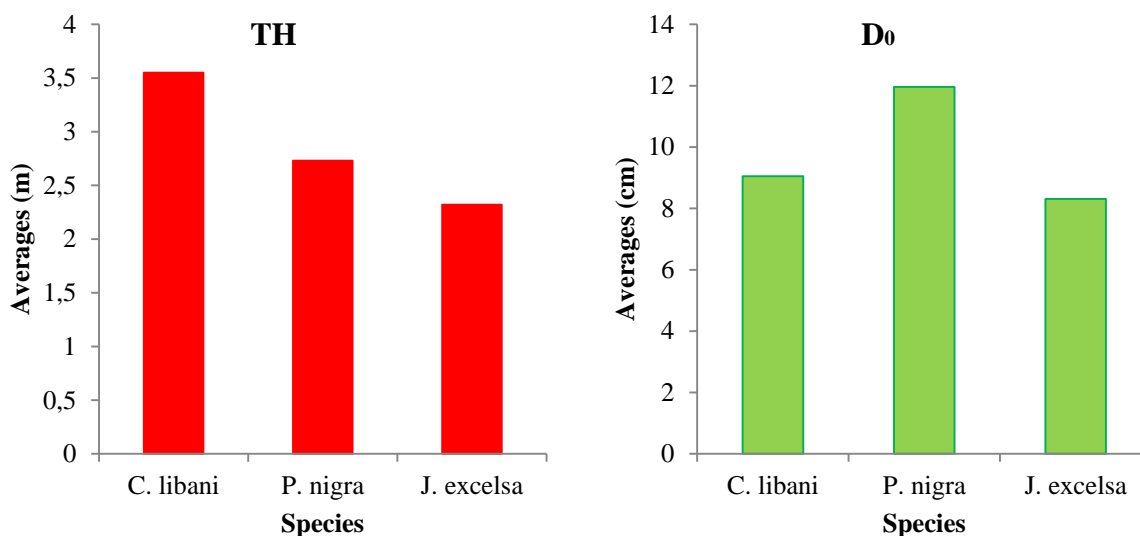
## RESULTS AND DISCUSSION

Averages, ranges and standard deviation of tree height and diameter at base for the species were given in Table 2. Average of diameter at base was the highest in Anatolian black pine (*Pinus nigra*) (11.96 cm), while tree height was the highest in Taurus cedar (*Cedrus libani*) (3.55 m) (Table 2, Figure 2).

**Table 2.** Averages, minimum, maximum and standard deviation for the characteristics in the species.

	<i>C. libani</i>		<i>P. nigra</i>		<i>J. excelsa</i>	
	TH (m)*	D <sub>0</sub> (cm)	TH (m)	D <sub>0</sub> (cm)	TH (m)	D <sub>0</sub> (cm)
<b>Averages</b>	3.55 <sup>c</sup>	9.05 <sup>a</sup>	2.73 <sup>b</sup>	11.96 <sup>b</sup>	2.32 <sup>a</sup>	8.31 <sup>a</sup>
<b>Minimum</b>	1.95	5.96	1.87	7.50	1.85	6.08
<b>Maximum</b>	5.50	15.33	4.05	15.38	3.25	11.38
<b>St. deviation</b>	2.36	.91	.60	2.59	.38	1.33

\*; Same letters are not significantly ( $p > 0.01$ ) different among the species.



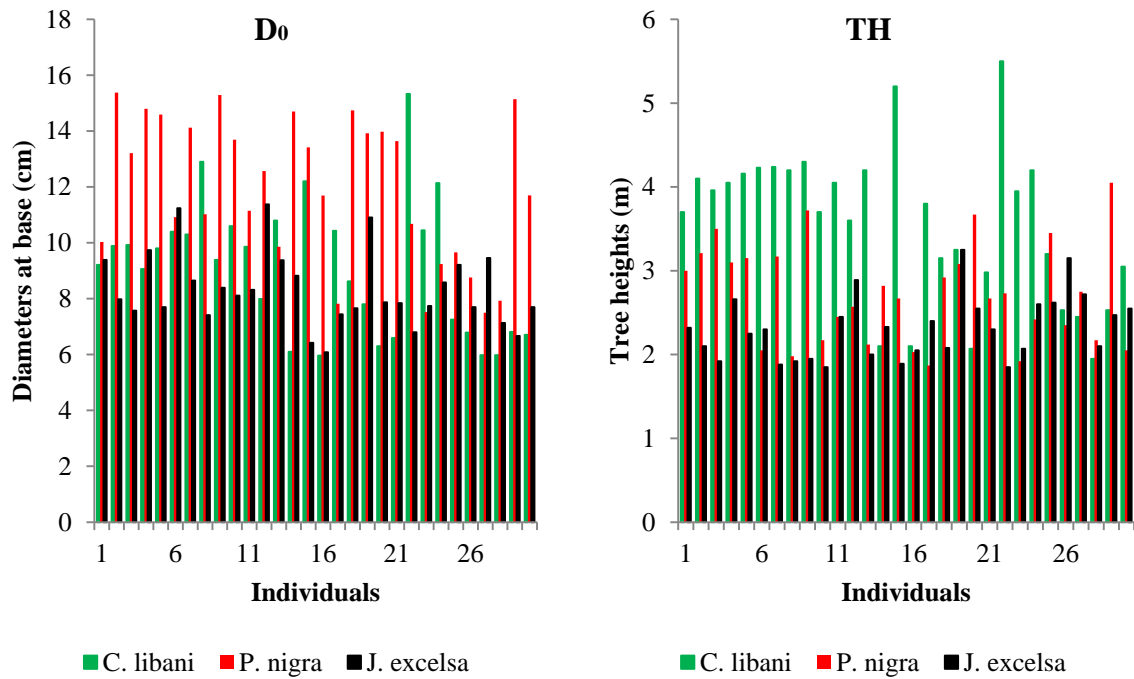
**Fig. 2.** Averages of the characteristics for the species

Averages were 9 m in *C. libani* and 12.3 m in *P. nigra* of tree height, and 27.2 cm in *C. libani* and 40.9 cm in *P. nigra* of diameter at base in an afforestation area from southern Turkiye (Kartal and Bilir, 2022). Annual increments of *C. libani*, *P. nigra* and *J. excelsa* were 0.24 m, 0.18 m and 0.15 m for tree height, and 0.30 cm, 0.80 cm and 0.55 cm in the species, respectively (Table 2). The increments of *C. libani* and *P. nigra* were reported 0.30 m and 0.41 m for tree height, and 0.91 cm and 1.36 cm for diameter at base in the species in a thirty year afforestation, respectively (Kartal and Bilir, 2022). Similar higher performances of *P. nigra* to *C. libani* were also reported by Özel (2018). The results indicated importance of species, location and age in afforestation practices.

Individual trees showed also large differences within species for the characteristics. Individual tree heights were ranged from 1.95 m to 5.50 m in *C. libani*, from 1.87 to 4.05 in *P. nigra*, and from 1.85 to 3.24 in *J. excelsa*. It was between 1.95 and 5.20 cm in *C. libani*, between 7.50 and 15.38 cm in *P. nigra*, and between 6.08 and 11.38 cm in *J. excelsa* for diameter at base (Table 2, Figure 3). Similar variations among individuals were also found for tree height and diameter at base in *C. libani* and *P. nigra* (Kartal and Bilir, 2022; Özel, 2018), and reproductions of *P. nigra* (Ertugrul and Bilir, 2020).



**4TH INTERNATIONAL LATIN AMERICAN  
CONGRESS ON NATURAL AND APPLIED SCIENCES**



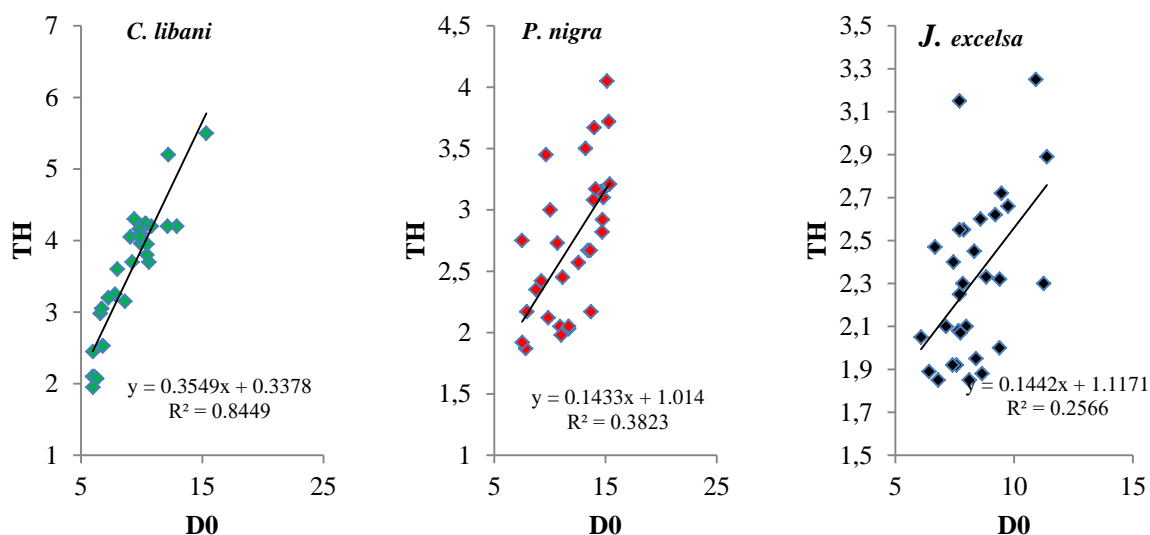
**Fig. 3.** Individual tree height and diameter at base in the species

According to results of analysis of variance showed significant ( $p \leq 0.01$ ) differences among the species for tree height and diameter at base (Table 3). The results were well accordance between *C. libani* and *P. nigra* for tree height and diameter at base in (Kartal and Bilir, 2022; Özel, 2018). The species were more homogenous for diameter at base than tree height according to Duncan's multiple range' test (Duncan, 1955) (Table 2). The results emphasized importance of tree species and characteristics in afforestation and forestry practices.

**Table 3.** Results of analysis of variance for the characteristics of the species

Characteristics	Source of variation	df	Mean Square	F	P value
<b>D<sub>0</sub></b>	Between Groups	2	111.378	23.815	.000
	Within Groups	87	4.677		
	Total	89			
<b>TH</b>	Between Groups	2	11.851	26.663	.000
	Within Groups	87	.444		
	Total	89			

Positive and significant ( $p \leq 0.05$ ) phenotypic relations between tree height and diameter at base in *C. libani* ( $r_p = .919$ ), *P. nigra* ( $r_p = .618$ ) and *J. excelsa* ( $r_p = .507$ ) according to results of correlation analysis (Figure 4). Similar findings were reported in plantation areas of *C. libani* and *P. nigra* (Kartal and Bilir, 2022; Özel, 2018), and reproductions of *P. nigra* (Ertugrul and Bilir, 2020). The results could be used forestry practices such as forest tending, and future studies in the species.



**Fig. 4.** Relations between tree height and diameter at base in the species

## CONCLUSIONS

Results of the study showed importance of selection of tree species in afforestation practices. Relations between the characteristics could be a tool for future studies in the species. The study was carried out in an afforestation area of the species by one year data and limited characteristics. Future studies could be carried out in different locations, species, soil preparation methods, and characteristics such as survival.

## REFERENCES

- Duncan, DB. (1955) Multiple range and multiple F-test. *Biometrics*, 11,1-5.
- Ertuğrul, G.S., Bilir N. (2020). Evaluation on natural regenerations in Kütahya-Simav district of Anatolian black pine. *Artvin Coruh University Journal of Forestry Faculty*, 21(1), 75-81.
- Falconer, D.S. (1989). Introduction to Quantitative Genetics. 3<sup>rd</sup> Edition, Longman Scientific and Technical, New York.
- Göl, C., Yel, S. (2016). Assessing the effects of different soil preparation methods on sampling growth in afforestation studies. *Turkish Journal of Forestry*, 17(2): 125-131.

**4TH INTERNATIONAL LATIN AMERICAN  
CONGRESS ON NATURAL AND APPLIED SCIENCES**

- Kartal, R., Bilir, N. (2022). Evaluation of Ehrami black pine plantations in Isparta district: 30<sup>th</sup> year results. *Bartın University International Journal of Natural and Applied Sciences*, 5:10-17.
- OGM. (2022). Forestry Statistics-2021. [www.ogm.gov.tr](http://www.ogm.gov.tr). Turkiye, Ankara (Date of access: 15.07.2022).
- Özel, S. (2018). Silvicultural evaluation of plantations in Isparta-Yalvaç district. Graduate School of Natural and Applied Science, Suleyman Demirel University, PhD. Thesis, Isparta.
- SPSS. (2011). IBM SPSS Statistics for Windows, Version 20.0., NY: IBM Corp.

Serim Tuna KOÇ

Trakya Üniversitesi Fen Bilimleri Enstitüsü Biyoteknoloji ve Genetik Anabilim Dalı

ORCID NO: 0000-0002-6216-6351

## ÖZET

Antosiyaninler, bitkiler alemindeki en yaygın doğal pigmentlerden biridir. Bitkisel besinlerin kırmızıdan mora kadar değişen renklerinden sorumlu olan ve insan sağlığına olumlu etkisi olan suda çözünür pigmentlerdir. pH ve sıcaklık değişimlerine karşı çok hassastırlar. Antosiyaninler, polifenoller grubuna ait flavonoid maddelerdir. Çoğu meyve, sebze ve çeşitli içeceklerde (meyve suyu, bira, şarap ve kahve) yaklaşık 7.000 farklı flavonoid bulunur. Her bitki türü, kırmızıdan maviye bir dizi renk sergileyen, dolayısıyla meyve ve sebzelerin renklerini taşıyan karakteristik bir antosiyanin pigmentine sahiptir. Antosiyaninler doğada O-glikozitler şeklinde bulunurlar, bunların aglikonlarına (sakkarit olmayan kısım) antosiyanidinler denir. En yaygın antosiyanidinler, siyanidin, delfinidin, peonidin, malvidin, pelargonidin ve petunidindir. Antosiyaninlerin insan sağlığı üzerindeki yararlı etkileri 16. yüzyıldan beri bilinmektedir. Antosiyaninler, antiinflamatuvar, antikanser, antimikrobiyal, anti-obezite ve antidiyabetik etkilerinin yanı sıra kardiyovasküler hastalıklar üzerinde koruyucu etkilere sahiptir. *Aronya* (*Aronia melanocarpa*), yüksek fenolik bileşik içeriği, antioksidan özellikleri ve sağlık üzerindeki olumlu etkisi nedeniyle son yıllarda tüketiciler tarafından tercih edilen bir meyve türüdür. Aronia, içindeki antosiyaninler toplam polifenollerin yaklaşık %25'ini oluşturur. Antosiyanin miktarının %64'ünü siyanidin-3-galaktosid ve %29'unu siyanidin-3-arabinosid oluşturmaktadır. Ayrıca, eser miktarda pelargonidin 3-O-galaktosid ve pelargonidin arabinosid tespit edilmiştir. Antosiyaninler ise meyvenin hem kabuğunda hem de etinde bulunmaktadır. Meyvenin olgunlaşma sırasındaki antosiyanin konsantrasyonu, rengi ve görsel çekiciliği artırır. Bu derlemede aronya meyvesindeki antosiyaninler ve sağlık üzerine olan etkilerine ilişkin araştırma sonuçları sunulmuştur.

**Anahtar Kelimeler:** Aronya, Polifenol, Sağlık

## **ABSTRACT**

One of the most prevalent naturally occurring pigments in the plant kingdom is anthocyanin. These are water-soluble pigments that give plant meals their colors, which range from red to purple, and they are beneficial to human health. They are extremely sensitive to changes in temperature and pH. Anthocyanins are flavonoid compounds that fall under the category of polyphenols. Most fruits, vegetables, and diverse drinks include one of the approximately 7,000 distinct flavonoids (e.g., juice, beer, wine, and coffee). Each plant species has a distinctive anthocyanin pigment that displays a spectrum of colors from red to blue, giving fruits and vegetables their distinct hues. In nature, anthocyanins appear as O-glycosides; their aglycones (non-saccharide parts) are known as anthocyanidins. Cyanidine, delphinidine, peonidine, malvidine, pelargonidine, and petunidine are the most prevalent anthocyanidins. Since the 16th century, anthocyanins have been associated with improved human health. Due to its high phenolic component content, antioxidant qualities, and advantageous effects on health, aronia (*Aronia melanocarpa*) has become a popular fruit type in recent years. Aronia contains roughly 25% of the total amount of polyphenols in anthocyanins. Cyanidin-3-galactoside makes up 64% of the anthocyanin content, whereas cyanidin-3-arabinoside makes up 29%. Furthermore, pelargonidin 3-O-galactoside and pelargonidin arabinoside in trace levels were found. The fruit's surface and flesh are both covered in anthocyanins. Fruit's anthocyanin concentration grows as it ripens, giving it more color and aesthetic appeal. Research findings on the anthocyanins in aronia fruit and their impact on health are discussed in this review.

**Key Words:** Aronia, Polyphenols, Health

**4TH INTERNATIONAL LATIN AMERICAN  
CONGRESS ON NATURAL AND APPLIED SCIENCES**

**EVALUTION OF ATOMIC PROPERTIES FOR LI-LIKE IONS SYSTEMS USING HARTREE-FOCK AND  
CONFIGURATION INTERACTION METHODS**

**Prof.Dr.Qassim Shamkhi al khafaji**

Physics Department / Faculty of Science/ University of Kufa/ Iraq

**Prof.Dr.shaymaa Awad Kadhim**

Physics Department / Faculty of Science/ University of Kufa/ Iraq

**Noor Ali jaafar**

AMAL ALHAYAT HOSPITAL

**Hasanain Alawadi**

Department of Ecology, Faculty of Science, University of Kufa, Iraq

**PhD.Ihab Alfadhel**

Department of Geology / Faculty of Science/ University of Kufa/ Iraq

**ABSTRACT**

In this study, we investigated the effect of electron correlation for three-electrons systems ,on the K-shell , KL(<sup>1</sup>S)-shells (singlet states) and KL(<sup>3</sup>S)-shells (triplet states) in the ground state of Li-like ions (Li atom, Be<sup>+</sup> ion, B<sup>+2</sup> ion, and C<sup>+3</sup> ion). Among the atomic properties, are the inter-particle distribution function  $f(r_{12})$  for the Hartree -Fock (HF) and configuration interaction (CI) wave function approximations. The one-particle radial density distribution function  $D(r)$  expected values for the two techniques and  $(\langle r_1^n \rangle, \langle r_{12}^n \rangle)$  where n is an integer number from -2 to 2 ,the standard deviation  $\Delta r_1$  and  $\Delta r_{12}$ .The properties of the energies expectation values, repulsion potential energy  $\langle V_{ee} \rangle$ , attractive potential energy  $\langle V_{en} \rangle$  , total potential energy  $\langle V \rangle$  , kinetic energy  $\langle T \rangle$  and total energy  $\langle E \rangle$ . In conclusion increasing the atomic number leads to an increase in all studied energies by increasing the amount of ionization of the studied elements with both approximations, and it was found that the CI is the closest to the practical values, because it takes into account the neglected electronic bonding by the HF method. Finally, the equations have been programmed in Mathematics 2015 and all calculations have been calculated in atomic units.

**Keywords:** singlet states, triplet states, repulsion, Hartree, Mathematic



## INTRODUCTION

The foundation of the current quantum mechanics were laid in 1926 by Schrodinger , who published a series of papers on the subject [1].Schrodinger (2003), introduced the wave equation which was subsequently extended and successfully applied to a large number of problems . Since, it has become generally accepted that the Schrodinger wave equation offers an accurate description of microscopic phenomena. This wave equation can be solved exactly for the Hydrogen atom and Hydrogen molecular ion, with single electron . However , for a larger atom or molecule , the problem is made more complicated by the presence of potential energy terms which arise from the mutual repulsion between any two electrons . In practice the exact solution to the Schrodinger equation for many electron system is unobtainable[2] . In order to make the problem tractable it is necessary to have make use of approximate methods .This is the knowledge of the physics of the problem becomes important[3]. Any approximations which are made in solving the problem must be physically reasonable if meaningful results are to be obtained .The first and simplest of such approximations is due to Hartree [4] . In Hartree, the wave function  $\psi$  , for an N-electron system, can be written as a single product of N (one electron spin orbitals) [5]:

$$\begin{aligned}\Psi(1, 2, 3, \dots, N) &= \phi(1)\phi(2)\phi(3)\dots\dots\phi(N) \\ &= \phi_i(i)\dots\dots\phi_N(N) \end{aligned} \quad (1)$$

Where  $i = 1$  to  $N$ .  $\phi_i(i)$  depends on the space and spin coordinates of electron  $i$ . The resulting wave function is known as a Hartree product. According to the Pauli exclusion principle, the wave function must change sign on interchanging of any two electrons, i.e., the wave function must be antisymmetric. In addition, it also fails to take into account the indistinguishability of the electrons. Later on, Hartree and Fock used a new approximation of the wave function in which, Pauli exclusion principle was satisfied[6]. In the Hartree -Fock approximation, the coulombic electron-electron repulsion between electrons is taken into account by integrating the repulsion, this gives the average effect of the repulsion . The total wave function is written as single Slater determinate [7].

$$\Psi(1,2,3,\dots,N) = \frac{1}{\sqrt{N!}} \cdot \begin{vmatrix} \phi_1(1) & \phi_1(2) & \dots & \phi_1(N) \\ \phi_2(1) & \phi_2(2) & \dots & \phi_2(N) \\ \vdots & \vdots & \vdots & \vdots \\ \phi_N(1) & \phi_N(2) & \dots & \phi_N(N) \end{vmatrix} \quad (2)$$

The component of one particle function  $\phi_i(i)$  is referred to as spin-orbital. Any spin orbital may be written as the product of space orbital  $\phi$  and a spin Eigen function  $\alpha$  or  $\beta$ . The numbers in the parentheses denote the particles, and the subscripts 1,2...N denote the Eigen states. The inter change of any two-particle causes the sign of  $\psi$  to change, since it involves the interchange of corresponding two columns. This observation leads to a more familiar expression of the Pauli principle. One can easily prove that the probability of finding two electrons with the same spin at the same point in space is zero. The wave function for the one particle is defined as [8] :

$$(3) \quad \Psi_{n \ell m_\ell m_s}(\bar{r}) = R_{n\ell}(r) Y_{\ell m_\ell}(\theta, \phi) \sigma(s)$$

The radial factor  $R_{n\ell}(r)$  is related to the distance of electron from the nucleus and depends on the  $n$  (principal quantum number) and  $\ell$  (angular momentum quantum number) while the angular factor (spherical harmonic)  $Y_{\ell m}(\theta, \phi)$  supplies an angle dependence and depends on the  $\ell$  and  $m_\ell$  (magnetic quantum number). The quantum numbers  $n$ ,  $\ell$  and  $m_\ell$  take the value as following [9] :

$$\left. \begin{array}{l} n = 1, 2, 3, \dots \\ \ell = 0, 1, 2, \dots, (n-1) \\ m_\ell = 0, \pm 1, \pm 2, \dots, \pm \ell \end{array} \right\} (4)$$

The spin factor represents the forth quantum number which is added to complete the total representation of the wave function, and it can take only the values

$$+\frac{1}{2} \text{ or } -\frac{1}{2}$$

The basis set of one electron function chosen is consisted of the normalized Slater-type orbital defined by [10]:

$$(5) \quad \chi_{n\ell m} = \frac{(2\zeta)^{n+\frac{1}{2}}}{[(2n)!]^{1/2}} r^{n-1} e^{-\zeta r} Y_{\ell m}(\theta, \varphi)$$

The partitioning into its pair wise component (i, j), the two-particle density can be written as [11]:

Where the pair function can be defined as in eq.6[11].

$$A_{ij}^{mn} = \phi_i(m)\phi_j(n) - \phi_j(m)\phi_i(n) \quad (6)$$

$$(7) \quad \Gamma_{ij}(x_m, x_n) = \frac{1}{2} \sum_{i < j}^N A_{ij}^* A_{ij}$$

by substituting eq.(6) into eq. (7) we can find :

$$(8) \quad \Gamma_{ij}(x_m, x_n) = \frac{1}{2} \sum_{i < j}^N [\phi_i(x_m)\phi_j(x_n) - \phi_j(x_m)\phi_i(x_n)]^2$$

There were many studies that included the use of equations for calculating atomic properties, and depending on the most recent , there was a study on the atomic open shell analysis of the boron ion in the (1s and 2s) states using the Hartree -Fock (HF) approach. The energies and some atomic properties for each boron ion shell (K-shell, KL (singlet) and KL (triplet)) were calculated [12].

**CALCULATION**

a) Two-particle radial density distribution function  $D(r_1, r_2)$ :

In each individual electronic shell, the two-particle radial density distribution function  $D(r_1, r_2)$  is defined by (Al-Akaishi & Al-Khafaji, 2022).

$$(8) \quad D(r_1, r_2) = \iint \Gamma(r_1, r_2) r_1^2 r_2^2 d\Omega_1 d\Omega_2$$

Where  $d\Omega_i$  denotes integration over all angular coordinates of the position vector  $r_i$ , and it is defined as [13]:

$$(9) \quad d\Omega_i = \sin\theta_i d\theta_i d\phi_i$$

The normalize condition for the two-particle radial density distribution function  $D(r_1, r_2)$  is defined as [12].

$$(10) \quad \iint D(r_1, r_2) dr_1 dr_2 = 1$$

This means the two-particle density distribution  $D(r_1, r_2) dr_1 dr_2$  is a measure of probability of finding the two-electron simultaneously and their radial coordinates are in the range  $r_1$  and  $r_1 + dr_1$ , and  $r_2$  to  $r_2 + dr_2$ .

b) One-particle radial density distribution function  $D(r_1)$ :

The radial density distribution function  $D_{ij}(r_1)$  is a measure of the probability of finding an electron in each shell and it is defined as [14]:

$$(11) \quad D_{ij}(r_1) = \int_0^{\infty} D_{ij}(r_1, r_2) dr_2$$

c) One-particle expectation value  $\langle r_1^n \rangle$ :

The one-particle expectation value  $\langle r_1^n \rangle$  can be calculated from [15]:

$$(12) \quad \langle r_1^n \rangle = \int D_{ij}(r_1) r_1^n dr_1$$

**4TH INTERNATIONAL LATIN AMERICAN  
CONGRESS ON NATURAL AND APPLIED SCIENCES**

In the case (n=0) one can calculate the Normalization condition  $\langle 1 \rangle = 1$ .

d) The inter-particle expectation values  $\langle r_{12}^n \rangle$ :

The inter-particle expectation values  $\langle r_{12}^n \rangle$  can be calculated from [16]:

$$(13) \quad \langle r_{12}^n \rangle = \int f_{ij}(r_{12}) r_{12}^n dr_{12}$$

e) Standard deviation  $\Delta r_1$

The standard deviation of the distance of the test electron from the nucleus  $r_1$ , is defined as [17]:

$$(14) \quad \Delta r_1 = \sqrt{\langle r_1^2 \rangle - \langle r_1 \rangle^2}$$

f) Standard Deviation  $\Delta r_{12}$

The standard deviation of the inter electronic distance of the two electrons, is defined as [17]:

$$(15) \quad \Delta r_{12} = \sqrt{\langle r_{12}^2 \rangle - \langle r_{12} \rangle^2}$$

g) Energy expectation value  $\langle E \rangle$ :

The energy expectation value associated with the Hamiltonian operator can be written as follows[18]:

$$E = \langle \hat{H} \rangle = \int \psi^* \hat{H} \psi d\tau \quad (16)$$

And  $\hat{H}$  for the N-electron system is given by[18]:

**4TH INTERNATIONAL LATIN AMERICAN  
CONGRESS ON NATURAL AND APPLIED SCIENCES**

$$\hat{H} = -1/2 \sum_i^N \nabla_i^2 - \sum_i^N \frac{Z}{r_i} + \sum_{i<j}^N \frac{1}{r_{ij}} \quad (17)$$

Since  $E = T + V_{en} + V_{ee}$ , equation 17 is used to find the expectation values of the kinetic and potential energies, and is given by [19]:

$$\langle T \rangle = -1/2 \int \psi^* \left[ \sum_i^N \nabla_i^2 \right] \psi d\tau \quad (18)$$

$$\langle V \rangle = \int \psi^* \left[ \sum_i^N -\frac{Z}{r_i} + \sum_{i<j}^N \frac{1}{r_{ij}} \right] \psi d\tau \quad (19)$$

For an N-electron atomic wave function that satisfies the virial theorem the energy expectation value is related to the potential energy by [19].

$$\langle E \rangle = 1/2 \langle V \rangle \quad (20)$$

The potential energy is simplifying the sum of the electron-nuclear attraction energy and the inter electronic repulsion energy, which are proportional to the expectation values of  $1/r_1$  and  $1/r_{12}$  respectively. Therefore, equation 19 can be written as [9]:

$$\langle V \rangle = -Z \langle r_1^{-1} \rangle + \langle r_{12}^{-1} \rangle \quad (21)$$

The expectation value  $\langle r_1^{-1} \rangle$  and  $\langle r_{12}^{-1} \rangle$  are defined by 12 and 13 equations respectively. These were related to the density distribution  $D(r_1)$  and distribution function  $f(r_{12})$  which are defined previously.

## RESULTS AND DISCUSSIONS

Depending on the tables (1,2,3,and 4), we found the one-particle expectation values  $\langle r_1^n \rangle$  for (Li atom, Be+ ion, B+2 ion, and C+3 ion), when  $n=0$ , then  $\langle r_1^n \rangle = 1$ , this represents the normalization condition. As  $Z$  increases the values of  $\langle r_1^n \rangle$  increase for  $n$  negative values and vice versa for  $n$  positive values. For all systems the standard deviation values  $\Delta r_1$  decrease as  $Z$  increases. In all studied systems (three electrons), one-Particle Expectation Values  $\langle r_1^n \rangle$  for the K-shell is the largest compared to the values of other shells, when the values of  $n$  are negative and vice versa, because  $(n = -1)$  represents an attractive force between the electron and the nucleus of the K-shell, it is the largest due to its proximity to the nucleus. We also note that the intermediate shells have the same one-Particle Expectation Values



**4TH INTERNATIONAL LATIN AMERICAN  
CONGRESS ON NATURAL AND APPLIED SCIENCES**

$\langle r_1^n \rangle$  with respect to the HF approximation due to the neglect of electronic bonding, while the CI method takes it into account. Related, the inter-particle expectation values  $\langle r_{12}^n \rangle$ , from the tables (5,6,7 and 8), when  $n=0$ , then  $\langle r_{12}^n \rangle = 1$ , this represents the normalization condition for the fourth studied elements, as  $Z$  increases the values of  $\langle r_{12}^n \rangle$  increases for  $n$  negative values and vice versa for  $n$  positive values in addition to the values of  $\langle r_{12}^n \rangle$  increases with the number of ionization for  $n$  negative values ( $\langle r_{12}^n \rangle_{\text{Li}} > \langle r_{12}^n \rangle_{\text{Be}^{+1}} > \langle r_{12}^n \rangle_{\text{B}^{+2}} > \langle r_{12}^n \rangle_{\text{C}^{+3}}$ ), and vice versa for  $n$  positive values. For all systems the standard deviation values  $\Delta r_{12}$  decreases as  $Z$  increases also these values decrease with the number of ionization.

Moreover, the energy expectation value  $\langle E \rangle$ , from the tables (9,10,11 and 12), can be noticed as  $Z$  increases, all the energies increase for all systems because the nuclear charge effect increases. The repulsion potential energy  $\langle V_{ee} \rangle$  increases with the number of ionization, this holds for the attraction potential energy  $\langle V_{en} \rangle$  but here the difference is large and holds for the energy values  $\langle V \rangle$ ,  $\langle T \rangle$ ,  $\langle E \rangle$ . Total values of  $\langle V_{ee} \rangle$  of HF wave function greater than of CI wave function for two electron system, from table 13, total values of  $\langle V \rangle$ ,  $\langle T \rangle$  and  $\langle E \rangle$  of CI wave function greater than HF wave function for all systems because the HF approximation neglects the electronic correlation energy all results for two methods compared with experimental results were shown in figure 1 and figure 2 below.

**Table 1.** Expectation values  $\langle r_1^n \rangle$  and standard deviation  $\Delta r_1$

for the individual shells and the normalized total values for the Li - atom

shell	n = -2		n = -1		n = 0		n = 1		n = 2		$\Delta r_1$	
	HF	CI	HF	CI	HF	CI	HF	CI	HF	CI	HF	CI
$K_{\alpha} K_{\beta}$	14.890	14.908	2.685	2.686	1	1	0.573	0.573	0.447	0.447	0.344	0.344
$K_{\beta} L_{\alpha}$	7.663	7.664	1.515	1.516	1	1	2.223	2.210	9.094	8.963	2.037	2.019
$K_{\alpha} L_{\alpha}$	7.663	7.694	1.515	1.519	1	1	2.223	2.209	9.094	8.962	2.037	2.019
Total	10.072	10.088	1.905	1.907	1	1	1.673	1.664	6.211	6.124	1.847	1.831

**Table 2.** Expectation values  $\langle r_1^n \rangle$  and standard deviation  $\Delta r_1$

for the individual shells and the normalized total values for the Be<sup>+</sup> - ion.

Shell	n = -2	n = -1	n = 0	n = 1	n = 2	$\Delta r_1$
-------	--------	--------	-------	-------	-------	--------------

**4TH INTERNATIONAL LATIN AMERICAN  
CONGRESS ON NATURAL AND APPLIED SCIENCES**

	HF	CI	HF	CI	HF	CI	HF	CI	HF	CI	HF	CI
$K_{\alpha} K_{\beta}$	27.767	27.778	3.682	3.683	1	1	0.415	0.415	0.233	0.233	0.247	0.246
$K_{\beta} L_{\alpha}$	14.609	14.584	2.145	2.144	1	1	1.348	1.345	3.161	3.150	1.159	1.158
$K_{\alpha} L_{\alpha}$	14.609	14.665	2.145	2.146	1	1	1.348	1.345	3.161	3.149	1.159	1.158
Total	18.995	19.009	2.633	2.658	1	1	1.037	1.035	2.185	2.176	1.054	1.052

**Table 3.** Expectation values  $\langle r_1^n \rangle$  and standard deviation  $\Delta r_1$

for the individual shells and the normalized total values for the  $B^{+2}$ - ion.

Shell	n = -2		n = -1		n = 0		n = 1		n = 2		$\Delta r_1$	
	HF	CI	HF	CI	HF	CI	HF	CI	HF	CI	HF	CI
$K_{\alpha} K_{\beta}$	44.640	44.644	4.681	4.680	1	1	0.325	0.325	0.143	0.143	0.192	0.192
$K_{\beta} L_{\alpha}$	23.812	23.758	2.772	2.769	1	1	0.981	0.979	1.636	1.632	0.821	0.819
$K_{\alpha} L_{\alpha}$	23.812	23.894	2.772	2.775	1	1	0.981	0.979	1.636	1.632	0.821	0.820
Total	30.756	30.766	3.408	3.409	1	1	0.762	0.762	1.138	1.136	0.746	0.746

**Table 4.** Expectation values  $\langle r_1^n \rangle$  and standard deviation  $\Delta r_1$

for the individual shells and the normalized total values for the  $C^{+3}$ - ion .

Shell	n = -2		n = -1		n = 0		n = 1		n = 2		$\Delta r_1$	
	HF	CI	HF	CI	HF	CI	HF	CI	HF	CI	HF	CI
$K_{\alpha} K_{\beta}$	65.508	65.518	5.679	5.671	1	1	0.267	0.268	0.096	0.097	0.157	0.158
$K_{\beta} L_{\alpha}$	35.267	35.075	3.398	3.389	1	1	0.774	0.773	1.005	1.003	0.637	0.6368
$K_{\alpha} L_{\alpha}$	35.267	35.271	3.398	3.396	1	1	0.774	0.773	1.005	1.003	0.637	0.637
Total	45.347	45.288	4.159	4.152	1	1	0.605	0.605	0.699	0.701	0.477	0.477

**Table 5.** Expectation values  $\langle r_{12}^n \rangle$  and standard deviation  $\Delta r_{12}$

**4TH INTERNATIONAL LATIN AMERICAN  
CONGRESS ON NATURAL AND APPLIED SCIENCES**

for the individual shells and the normalized total values for the Li- atom .

Shell	n = -2		n = -1		n = 0		n = 1		n = 2		$\Delta r_{12}$	
	HF	CI	HF	CI	HF	CI	HF	CI	HF	CI	HF	CI
$K_{\alpha} K_{\beta}$	4.717	4.636	1.649	1.565	1	1	0.839	0.864	0.894	0.930	0.435	0.429
$K_{\beta} L_{\alpha}$	0.195	0.194	0.323	0.322	1	1	3.922	3.905	18.187	19.973	1.675	1.651
$K_{\alpha} L_{\alpha}$	0.119	0.129	0.308	0.320	1	1	3.927	3.909	18.187	17.969	1.662	1.641
Total	1.677	1.653	0.760	0.736	1	1	2.896	2.892	12.423	12.957	1.257	1.240

**Table 6.** Expectation values  $\langle r_{12}^n \rangle$  and standard deviation  $\Delta r_{12}$  for

the individual shells and the normalized total values for the Be<sup>+</sup>- ion .

Shell	n = -2		n = -1		n = 0		n = 1		n = 2		$\Delta r_{12}$	
	HF	CI	HF	CI	HF	CI	HF	CI	HF	CI	HF	CI
$K_{\alpha} K_{\beta}$	8.917	8.914	2.273	2.209	1	1	0.607	0.620	0.466	0.481	0.312	0.309
$K_{\beta} L_{\alpha}$	0.590	0.590	0.548	0.545	1	1	2.323	2.325	6.322	6.323	0.962	0.957
$K_{\alpha} L_{\alpha}$	0.327	0.326	0.513	0.513	1	1	2.329	2.329	6.322	6.315	0.946	0.943
Total	3.264	3.277	1.112	1.089	1	1	1.753	1.758	4.370	4.373	0.739	0.737

**Table 7.** Expectation values  $\langle r_{12}^n \rangle$  and standard deviation  $\Delta r_{12}$

for the individual shells and the normalized total values for the B<sup>+2</sup>- ion.

**4TH INTERNATIONAL LATIN AMERICAN  
CONGRESS ON NATURAL AND APPLIED SCIENCES**

Shell	n = -2		n = -1		n = 0		n = 1		n = 2		$\Delta r_{12}$	
	HF	CI	HF	CI	HF	CI	HF	CI	HF	CI	HF	CI
$K_{\alpha} K_{\beta}$	14.449	14.337	2.897	2.817	1	1	0.475	0.484	0.285	0.293	0.243	0.243
$K_{\beta} L_{\alpha}$	1.169	1.169	0.766	0.760	1	1	1.673	1.676	3.271	3.277	0.686	0.684
$K_{\alpha} L_{\alpha}$	0.620	0.620	0.708	0.707	1	1	1.679	1.681	3.271	3.274	0.671	0.670
Total	5.413	5.375	1.457	1.428	1	1	1.276	1.277	2.278	2.281	0.534	0.532

**Table 8.** Expectation values  $\langle r_{12}^n \rangle$  and standard deviation  $\Delta r_{12}$

for the individual shells and the normalized total values for the  $C^{+3}$ - ion .

Shell	n = -2		n = -1		n = 0		n = 1		n = 2		$\Delta r_{12}$	
	HF	CI	HF	CI	HF	CI	HF	CI	HF	CI	HF	CI
$K_{\alpha} K_{\beta}$	21.312	21.310	3.521	3.388	1	1	0.391	0.398	0.192	0.191	0.199	0.199
$K_{\beta} L_{\alpha}$	1.931	1.931	0.979	0.920	1	1	1.312	1.312	2.009	2.009	0.536	0.536
$K_{\alpha} L_{\alpha}$	0.999	0.999	0.900	0.890	1	1	1.318	1.318	2.009	2.009	0.522	0.519
Total	8.081	8.079	1.800	1.733	1	1	1.007	1.009	1.404	1.407	0.419	0.418

**Table 9.** Expectation values of the Potential energy  $\langle V \rangle$ , Kinetic energy  $\langle T \rangle$

and Total energy  $\langle E \rangle$  for Li – atom.

**4TH INTERNATIONAL LATIN AMERICAN  
CONGRESS ON NATURAL AND APPLIED SCIENCES**

Shell	< V <sub>ee</sub> >		< V <sub>en</sub> >		< V >		< T >		< E >	
	HF	CI	HF	CI	HF	CI	HF	CI	HF	CI
$K \begin{smallmatrix} K \\ \alpha \beta \end{smallmatrix}$	1.649	1.565	-8.055	-8.057	-6.405	-6.492	3.203	3.246	-3.203	-3.246
$K \begin{smallmatrix} L \\ \beta \alpha \end{smallmatrix}$	0.322	0.322	-4.546	-4.548	-4.223	-4.226	2.111	2.113	-2.112	-2.113
$K \begin{smallmatrix} L \\ \alpha \alpha \end{smallmatrix}$	0.308	0.320	-4.546	-4.556	-4.237	-4.236	2.119	2.118	-2.119	-2.118
Total	2.281	2.208	-17.146	-17.162	-14.865	-14.954	7.433	7.477	-7.433	-7.477

**Table 10.** Expectation values of the Potential energy < V >, Kinetic energy < T > and Total energy < E > for Be<sup>+</sup> - ion.

Shell	< V <sub>ee</sub> >		< V <sub>en</sub> >		< V >		< T >		< E >	
	HF	CI	HF	CI	HF	CI	HF	CI	HF	CI
$K \begin{smallmatrix} K \\ \alpha \beta \end{smallmatrix}$	2.273	2.209	-14.729	-14.731	-12.457	-12.522	6.228	6.261	-6.228	-6.261
$K \begin{smallmatrix} L \\ \beta \alpha \end{smallmatrix}$	0.548	0.545	-8.579	-8.575	-8.032	-8.031	4.016	4.015	-4.016	-4.015
$K \begin{smallmatrix} L \\ \alpha \alpha \end{smallmatrix}$	0.513	0.513	-8.579	-8.598	-8.067	-8.086	4.033	4.043	-4.033	-4.043
Total	3.335	3.267	-31.889	-31.905	-28.555	-28.638	14.277	14.319	-14.277	-14.319

**Table 11.** Expectation values of the Potential energy < V >, Kinetic energy < T > and Total energy < E > for B<sup>+2</sup> – ion .

Shell	< V <sub>ee</sub> >		< V <sub>en</sub> >		< V >		< T >		< E >	
	HF	CI	HF	CI	HF	CI	HF	CI	HF	CI
$K \begin{smallmatrix} K \\ \alpha \beta \end{smallmatrix}$	2.897	2.816	-23.403	-23.402	-20.506	-20.585	10.253	10.293	-10.253	-10.273

**4TH INTERNATIONAL LATIN AMERICAN  
CONGRESS ON NATURAL AND APPLIED SCIENCES**

$K_{\beta}L_{\alpha}$	0.766	0.760	-13.860	-13.849	-13.094	-13.089	6.547	6.544	-6.547	-6.544
$K_{\alpha}L_{\alpha}$	0.708	0.707	-13.860	-13.877	-13.152	-13.169	6.576	6.585	-6.576	-6.585
Total	4.371	4.283	-51.124	-51.113	-46.753	-46.844	23.376	23.422	-23.376	-23.422

**Table 12.** Expectation values of the Potential energy  $\langle V \rangle$ , Kinetic energy  $\langle T \rangle$  and

Total energy  $\langle E \rangle$  for  $C^{+3}$  – ion .

Shell	$\langle V_{ee} \rangle$		$\langle V_{en} \rangle$		$\langle V \rangle$		$\langle T \rangle$		$\langle E \rangle$	
	HF	CI	HF	CI	HF	CI	HF	CI	HF	CI
$K_{\alpha}K_{\beta}$	3.521	3.388	-34.076	-34.023	-30.555	-30.635	15.277	15.317	-15.277	-15.317
$K_{\beta}L_{\alpha}$	0.979	0.920	-20.389	-20.339	-19.409	-19.419	9.705	9.709	-9.704	-9.709
$K_{\alpha}L_{\alpha}$	0.900	0.890	-20.389	-20.379	-19.489	-19.491	9.744	9.745	-9.744	-9.746
Total	5.401	5.199	-74.854	-74.741	-69.453	-69.545	34.326	34.773	-34.726	-34.773

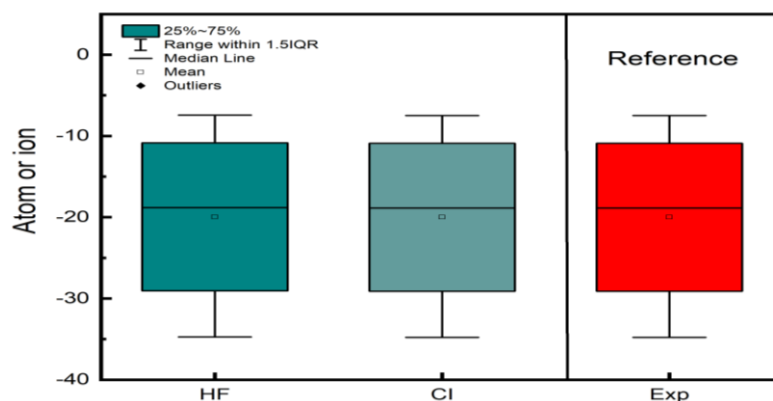


**4TH INTERNATIONAL LATIN AMERICAN  
CONGRESS ON NATURAL AND APPLIED SCIENCES**

**Table 13.** Hartree - Fock energies and correlation energies and overlap integrals between correlated and HF wave functions for Li – like ion .

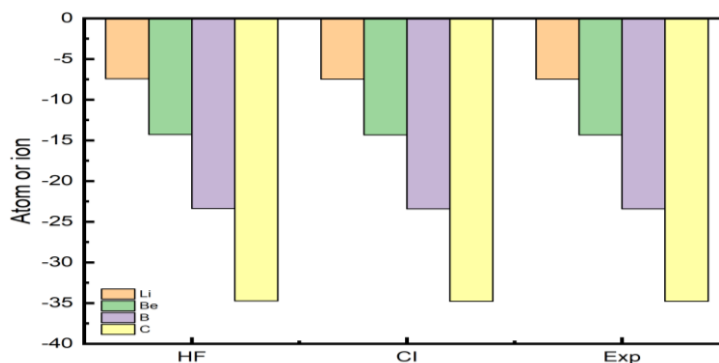
Atom or ion	Li	Be <sup>+</sup>	B <sup>+2</sup>	C <sup>+3</sup>
<b>HF</b>	-7.433	-14.277	-23.376	-34.726
<b>[20]</b>	-7.433	-14.277	-23.376	-34.726
<b>CI</b>	-7.477	-14.319	-23.422	-34.773
<b>Experiential [20]</b>	-7.478	-14.325	-23.425	-34.786

Depending on figure 1, the HF and CI methods were similar to the experimental results with a range of 25% to 75% same as the experimental presented as a reference in the figure. As a validation part of the results, we are confident the HF and CI are the best methods for ions and atoms.



**Figure 1.** A comparison of H.F and CI approximation methods with experimental results for studied elements.

**4TH INTERNATIONAL LATIN AMERICAN  
CONGRESS ON NATURAL AND APPLIED SCIENCES**



**Figure 1.** A comparison of H.F and CI approximation methods with experimental results for each studied element.

### CONCLUSION

Deduced for HF and CI wave functions methods for K-shell, through the this study of some atomic properties for Li-like ions (three system) , we concluded that , as Z increases the maximum values of inter-particle distribution function  $f(r_{12})$  and the one-particle radial density distribution function  $D(r)$  are increases and the positions of these maximum values decreases with Z increases . Related, the values of  $\langle r_1^n \rangle$  and  $\langle r_{12}^n \rangle$  increases for n negative values and decreases for n positive values. In this system the standard deviation values  $\Delta r_1$  and  $\Delta r_{12}$  decreases, all the energies are increases for this system .The repulsion potential energy  $\langle V_{ee} \rangle$  increases as the ionization increases , the values of  $\langle V \rangle$  ,  $\langle T \rangle$  and  $\langle E \rangle$  of CI wave function greater than HF wave function also It is closer to practical results, due to of neglecting the electronic bonding energy between electrons in HF method.

### ACKNOWLEDGEMENT

The work is partially supported by university of kufa ,faculty Science therefore so much thanks for them.

### REFERENCES

**4TH INTERNATIONAL LATIN AMERICAN  
CONGRESS ON NATURAL AND APPLIED SCIENCES**

1. Schrödinger, E., *Collected papers on wave mechanics*. Vol. 302. 2003: American Mathematical Soc.
2. Nakatsuji, H., *Discovery of a general method of solving the Schrodinger and dirac equations that opens a way to accurately predictive quantum chemistry*. Accounts of Chemical Research, 2012. **45**(9): p. 1480-1490.
3. Oppen, M. and D. Saad, *Advanced mean field methods: Theory and practice*. 2001: MIT press.
4. van Schilfhaarde, M., T. Kotani, and S.V. Faleev, *Adequacy of approximations in GW theory*. Physical Review B, 2006. **74**(24): p. 245125.
5. Patchkovskii, S., et al., *High harmonic generation and molecular orbital tomography in multielectron systems: Beyond the single active electron approximation*. Physical review letters, 2006. **97**(12): p. 123003.
6. Kaplan, I.G., *The Pauli exclusion principle: origin, verifications, and applications*. 2017: John Wiley & Sons.
7. Bubin, S., et al., *Born–Oppenheimer and non-Born–Oppenheimer, atomic and molecular calculations with explicitly correlated Gaussians*. Chemical reviews, 2013. **113**(1): p. 36-79.
8. Grigorenko, I. and M.E. Garcia, *Ground-state wave functions of two-particle systems determined using quantum genetic algorithms*. Physica A: Statistical Mechanics and its Applications, 2001. **291**(1-4): p. 439-448.
9. Trier, S.H., et al. *Estimation Hartree-Fock's energy for the carbon atom and the ions are similar*. in *Journal of Physics: Conference Series*. 2019. IOP Publishing.
10. Hoggan, P.E., *General two-electron exponential type orbital integrals in polyatomics without orbital translations*. International Journal of Quantum Chemistry, 2009. **109**(13): p. 2926-2932.
11. Mobbs, R. and K. Banyard, *Correlation effects in momentum space for the electronic shells in Be*. The Journal of Chemical Physics, 1983. **78**(10): p. 6106-6111.
12. Al-Khafaji, Q.S., et al., *Calculating the Energy of B+ 2-Ion Using Division Technique*. Journal of Advanced Physics, 2016. **5**(4): p. 364-367.
13. Al-Akaishi, A.H. and Q.S. Al-Khafaji. *Calculation of the subshells energy of Na-atom and isoelectronic series*. in *AIP Conference Proceedings*. 2022. AIP Publishing LLC.
14. King, A.W., L.C. Rhodes, and H. Cox, *Inner and outer radial density functions in correlated two-electron systems*. Physical Review A, 2016. **93**(2): p. 022509.
15. Valone, S.M., *A one-to-one mapping between one-particle densities and some n-particle ensembles*. The Journal of Chemical Physics, 1980. **73**(9): p. 4653-4655.
16. Al-Jibbouri, H. and A. Alhasan. *Study the inter-particle function for some electronic system*. in *Journal of Physics: Conference Series*. 2019. IOP Publishing.
17. AL-Khafiji, K.S., A.M. Selman, and S.A.K. Al-Shebly, *Calculation of the Standard Deviation and Nuclear Magnetic Shielding Constant for Lithium Atom*. Jornal of Kerbala University, 2008. **6**(2).
18. Al-Assady, A.F. and Q.S. Al-Khafaji. *Study of atomic properties for subshells of the systems have Z= 12-16 by using Hartree-Fock approximation*. in *IOP Conference Series: Materials Science and Engineering*. 2020. IOP Publishing.
19. Stevenson, R.B., *THE (NS)(2) SINGLET-S STATES OF THE HELIUM ATOM*. 1967: The University of Iowa.
20. Malykhanov, Y.B. and M. Gorshunov, *Energies of Atoms and Ions Calculated by the Hartree–Fock Method*. Journal of Applied Spectroscopy, 2013. **80**(5): p. 631-636.

**DESIGN AND MODEL OF AN INDUCTIVE WIRELESS POWER TRANSFER  
SYSTEM FOR ELECTRIC VEHICLES**

**Vekil SARI**

Sivas Cumhuriyet University

ORCID NO: 0000-0001-5963-0179

**ABSTRACT**

Wireless power transfer (WPT) systems has become very important in recent years. WPT is used in many areas. In this study, an inductive wireless power transfer (IWPT) system was designed for electric vehicles. The shape of the primary and secondary coils is circular and their radius is 25 cm. The operating frequency of the system is 20 KHz and the applied voltage is 100 volts. The effect of the distance between the primary and secondary coils on the efficiency of the system was investigated by generating a 3D Maxwell model of the system. The distance between the primary and secondary coils was modified as 10, 15, 20 and 25 cm and the coupling coefficient, mutual inductance, input power, output power and efficiency of the system were investigated in each case. As a result, it was observed that the coupling coefficient, the common inductance, and the efficiency of the system are inversely proportional with the distance between the coils. When the distance between the coils was 10 cm, the efficiency of the system was 84.21%. As the distance between the coils increases, the system efficiency decreases and when the distance between the coils is 25 cm, the system efficiency becomes 71.07%.

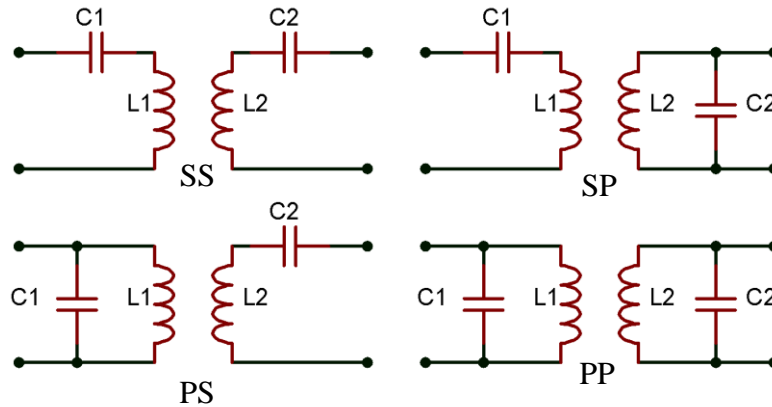
**Keywords:** Wireless power transfer, contactless power transfer, inductive power transfer.

**1. Introduction**

Wireless power transfer (WPT) systems have advantages such as simplifying the charging process by eliminating cables, not being affected by weather conditions and no arcing [1]. Therefore, it has become very important in recent years. WPT is used in many areas. One of them is the charging of electric vehicles. WPT systems are divided into inductive and capacitive. Inductive coupling has coils and a magnetic field is used for the transfer of energy. In capacitive coupling, there are conductive plates and electric field is used for the transfer of energy [2].

In IWPT systems, since the system is inductive, the power factor is low, and compensation is done to increase the power factor. Therefore, capacitors are connected in series or parallel to the primary and secondary coils. According to the serial and parallel connection status of the

capacitors, there are 4 different connection types as serial serial (SS), serial parallel (SP), parallel serial (PS) and parallel parallel (PP). Figure 1 shows the connection types. SS connection has some advantages over other connection types. These advantages are described in [3].



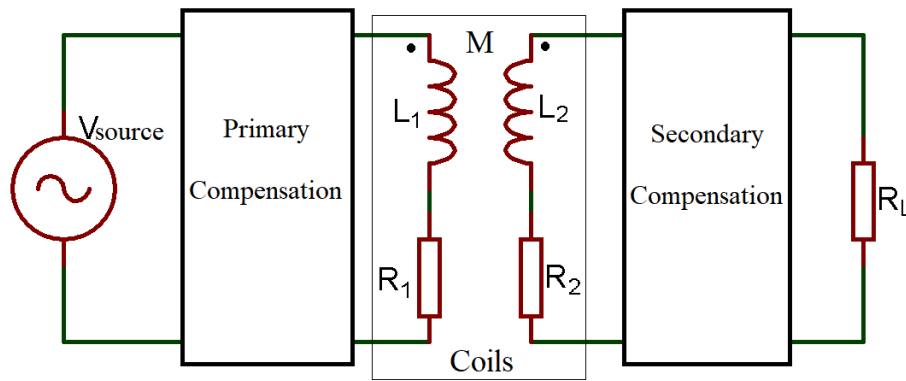
**Figure 1.** Capacitor connection types in IWPT systems.

The relationship between the resonant frequency, and the primary/secondary coils and capacitors in IWPT systems is given in Equation 1 [4]. Here,  $L_1$  is the inductance of the primary coil,  $L_2$  is the inductance of the secondary coil,  $C_1$  is the capacitance of the primary capacitor, and the  $C_2$  is the capacitance of the secondary capacitor. In systems with Serial-Serial connection, primary quality factor is calculated by Equation 2 and secondary quality factor is calculated by Equation 3 [5].

$$w_0 = \frac{1}{\sqrt{L_1 C_1}} = \frac{1}{\sqrt{L_2 C_2}} \quad (1)$$

$$Q_1 = \frac{R_L L_1}{w_0 M^2} \quad (2)$$

$$Q_2 = \frac{w_0 L_2}{R_L} \quad (3)$$



**Figure 2.** General schematic of an IWPT system [6].

The IWPT system consists of primary and secondary parts that are not in contact with each other, as shown in Figure 2. The primary part consists of a high frequency power supply, a capacitor  $C_1$  connected in series or parallel for primary compensation, and a primary coil. Secondary part consists of the secondary coil and the secondary capacitor  $C_2$  connected in series or parallel for secondary compensation and load.

In a previous study [7], the inductively coupled power transfer system was investigated and to validate the theoretical results, a 2-KW SS compensated prototype with a 15-cm air gap between coils, was implemented. The shape of the coils in this prototype is rectangular and the operating frequency is 20 KHz. The number of turns for the primary coil is 27, the number of turns for the secondary coil is 7. The theoretical efficiency of the system is 95% and the experimental efficiency is 82%.

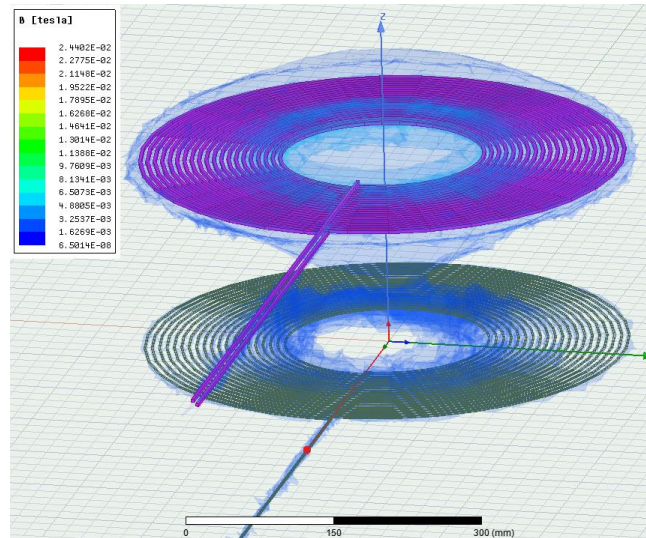
In another study [8], the compensation topologies of the inductively coupled power transfer system were investigated and a novel compensation topology was proposed. The proposed compensation topology is the SPS topology, which is a combination of SS and PS topologies. Then, two prototypes with SS and SPS compensation topologies were implemented. The dimensions of the primary and secondary coils which were wound using Litz wire, are different in order to consider misalignment in only one direction. The primary coil is rectangular, the secondary coil is square and the distance between them is 15 cm.

In another study [9], models of circular and DD-coupled inductive power transfer systems were generated with finite element analysis software. The power of the system is 2 KW and the distance between the coils is 20 cm. As a result, it was concluded that the DD-coupled system is more efficient.

## 2. Model of IWPT System

In this study, the IWPT system was designed, and then a 3D Maxwell model of this system was generated. The magnetic field representation of the 3D Maxwell model of the proposed IWPT system is shown in Figure 3.





**Figure 3.** Magnetic field representation of the IWPT system.

The coupling coefficient ( $k$ ), self-inductance of the primary coil ( $L_1$ ), self-inductance of the secondary coil ( $L_2$ ) and mutual-inductance ( $M$ ) when the distance between the primary and secondary coils is 10, 15, 20 and 25 cm were obtained from the model.  $C_1$  and  $C_2$  values from Equation 1,  $Q_1$  values from Equation 2 and  $Q_2$  values from Equation 3 were calculated. These values are given in Table 1.

**Table 1.** Design parameters of the IWPT system.

Distance	10 cm	15 cm	20 cm	25 cm
$k$	0,36	0,23	0,16	0,11
$L_1$ (uH)	162,08	162,04	161,95	161,69
$L_2$ (uH)	155,8	155,76	155,74	155,56
$M$ (uH)	58,03	38,02	25,66	17,76
$C_1$ (nF)	391,29	391,29	391,41	392,04
$C_2$ (nF)	406,86	407,12	407,12	407,65
$Q_1$	1,917	4,466	9,791	20,406
$Q_2$	3,913	3,911	3,911	3,906

Figure 4 shows the change of the coupling coefficient vs the distance between the coils. When this graph is analyzed, we can see that the coupling coefficient decreases as the distance between the coils increases and the coupling coefficient is 0.36 when the distance between the coils is 10 cm. When the distance between the coils is 25 cm, the coupling coefficient becomes 0.11. As shown in Figure 4, the coupling coefficient is inversely proportional to the distance between the coils.

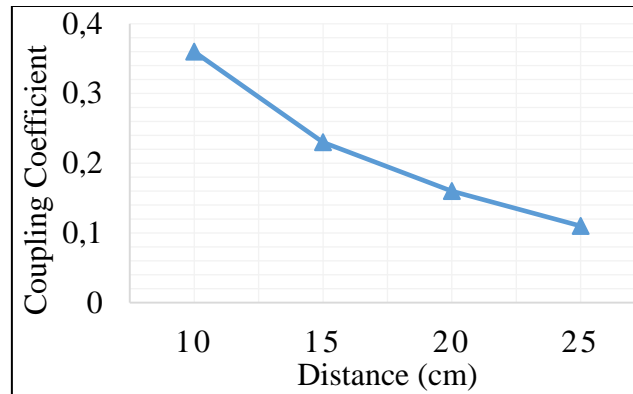


Figure 4. Coupling coefficient vs distance between the coils.

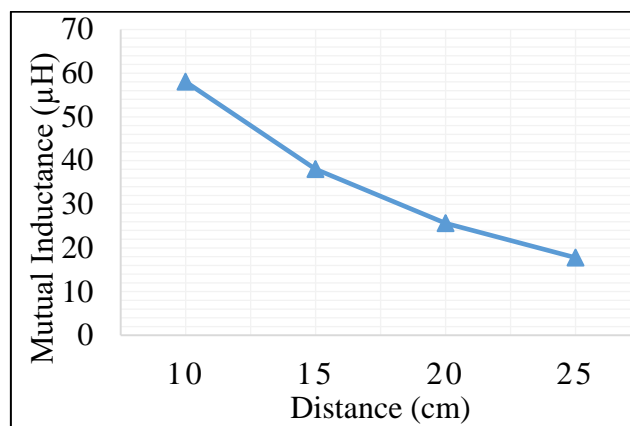


Figure 5. Mutual inductance vs distance between the coils.

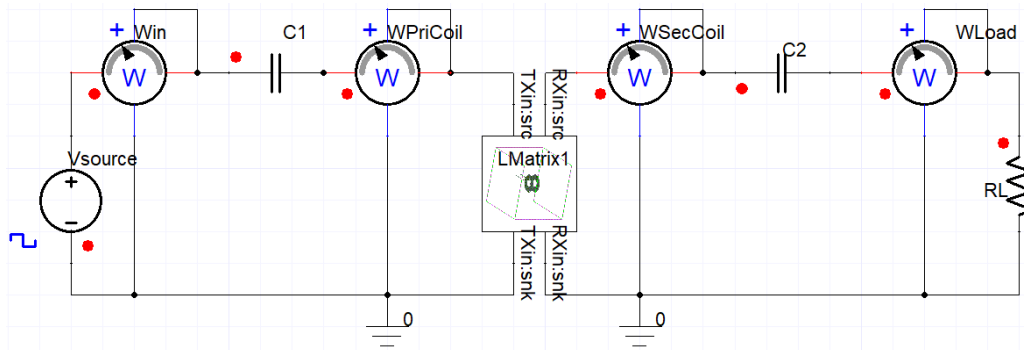
A coupling coefficient of zero means that there is no coupling, that is, the power transfer is zero. Conversely, the larger the coupling coefficient, the more power is transferred and the efficiency of the system increases. Therefore, it is desirable to have a large coupling coefficient in the design of IWPT systems. The coupling coefficient can be calculated by Equation 4 [10].

$$k = \frac{M}{\sqrt{L_1 L_2}} \quad (4)$$

Figure 5 shows the change of the mutual inductance vs the distance between the coils. As shown in Figure 5, the common inductance decreases as the distance between the coils increases.

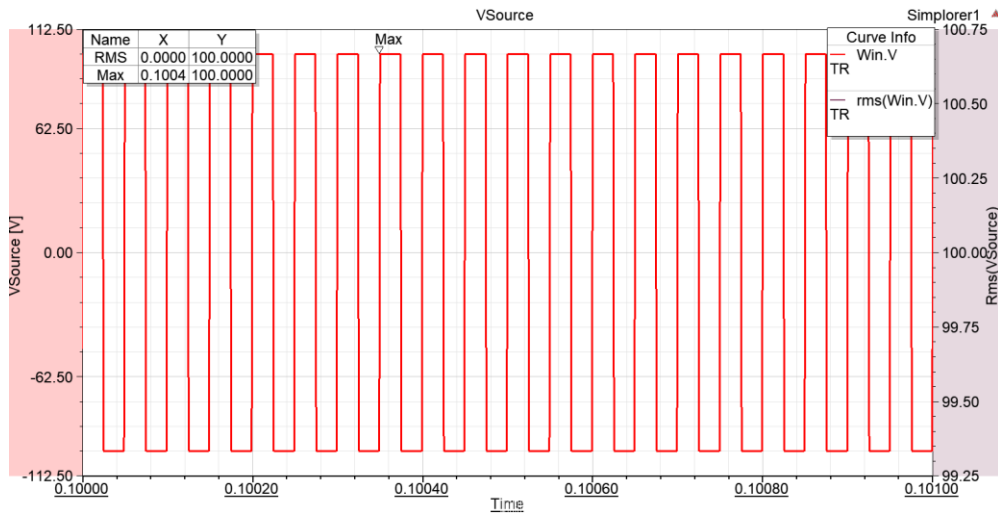
### 3. Simplorer Circuit

After the generation of the 3D Maxwell model of the IWPT system, the Simplorer circuit was built for efficiency analysis. Figure 6 shows the Simplorer circuit of the IWPT system. Here, the load resistance  $R_L$  is 5 ohms. As shown in Figure 7,  $V_{source}$  voltage is a bipolar square wave with an RMS value of 100 volts. As shown in Figure 8, the  $I_{source}$  current is a sinusoidal current with a maximum value of 12.2 amperes and an RMS value of 8.55 amperes.

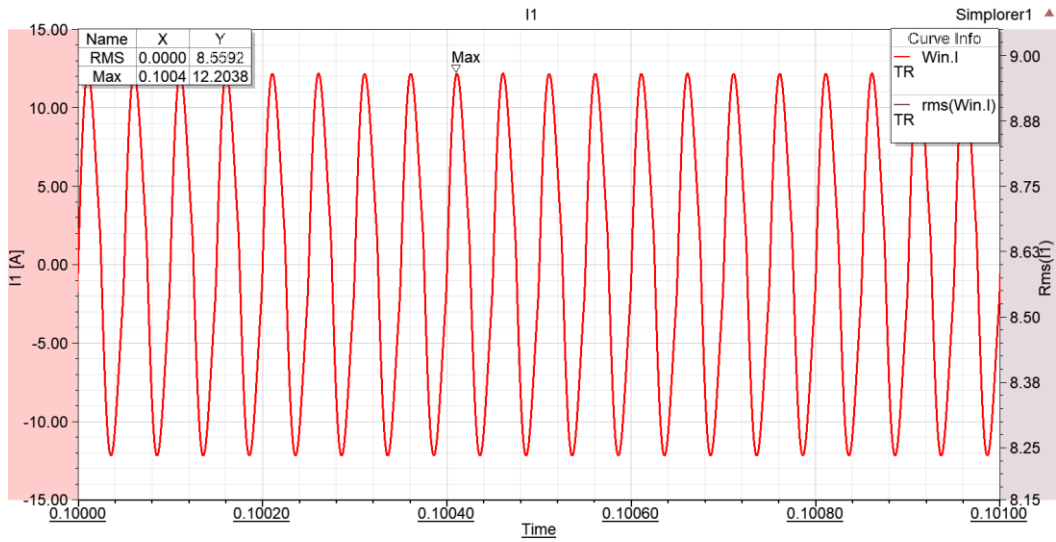


**Figure 6.** Simplorer circuit of IWPT system.

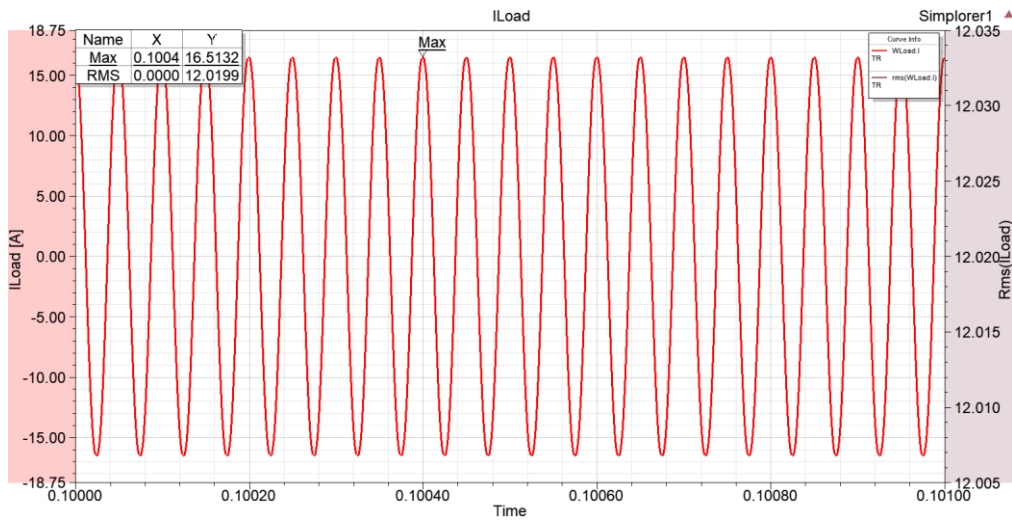
Figure 9 shows the load current  $I_L$ . As shown in Figure 9, the maximum value of the load current is 16.51 amperes, and the RMS value is 12.01 amperes. Figure 10 shows the load voltage  $V_L$ . As shown in Figure 10, the load voltage is a sinusoidal voltage with a maximum value of 82.56 volts and an RMS of 60 volts.



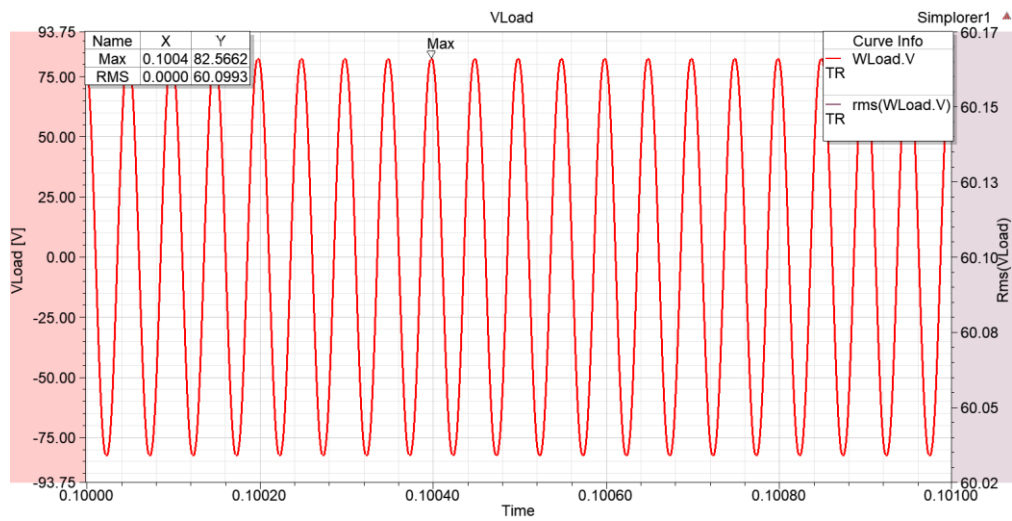
**Figure 7.**  $V_{source}$  voltage.



**Figure 8.**  $I_{source}$  current.



**Figure 9.**  $I_L$  current.



**Figure 10.**  $V_L$  voltage.

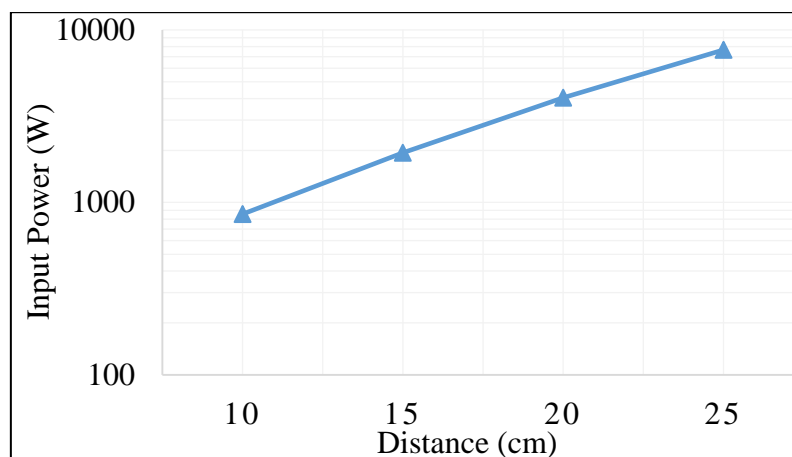
#### 4. Model results

The distance between the coils in the generated model was modified as 10, 15, 20 and 25 cm and the source current ( $I_{\text{source}}$ ), load current ( $I_L$ ), load voltage ( $V_L$ ), input power ( $P_{\text{in}}$ ) and output power ( $P_L$ ) were obtained in each case. The obtained values are given in Table 2.

**Table 2.** Model results.

Distance	10 cm	15 cm	20 cm	25 cm
$V_{\text{source}}$ (V)	100 V	100 V	100 V	100 V
$I_{\text{source}}$ (A)	8,55	19,4	40,4	76,57
$P_{\text{in}}$ (W)	855	1940	4040	7657
$V_L$ (V)	60	89,45	125,79	164,96
$I_L$ (A)	12	17,89	25,15	32,99
$P_L$ (W)	720	1600	3163	5442
Efficiency	84,21	82,48	78,3	71,07

In Figure 11, the change of the input power vs the distance between the coils is shown. In Figure 12, the change of the output power vs the distance between the coils is shown. These graphs demonstrate that the input power and the output power increase as the distance between the coils increases. Figure 13 shows the change of the system efficiency vs the distance between the coils. As shown in Figure 13, the efficiency of the system decreases as the distance between the coils increases, the efficiency of the system is 84.21% when the distance between the coils is 10 cm, and the efficiency of the system is 71.07% when the distance between the coils is 25 cm.



**Figure 11.** The input power vs the distance between the coils.

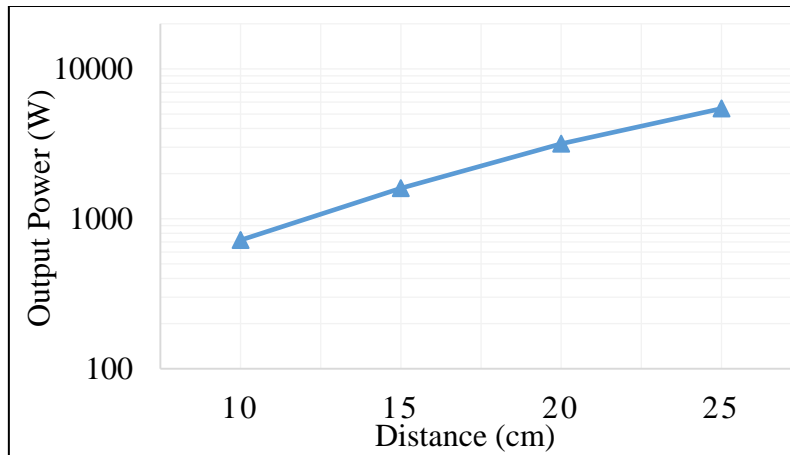


Figure 12. The output power vs the distance between the coils.

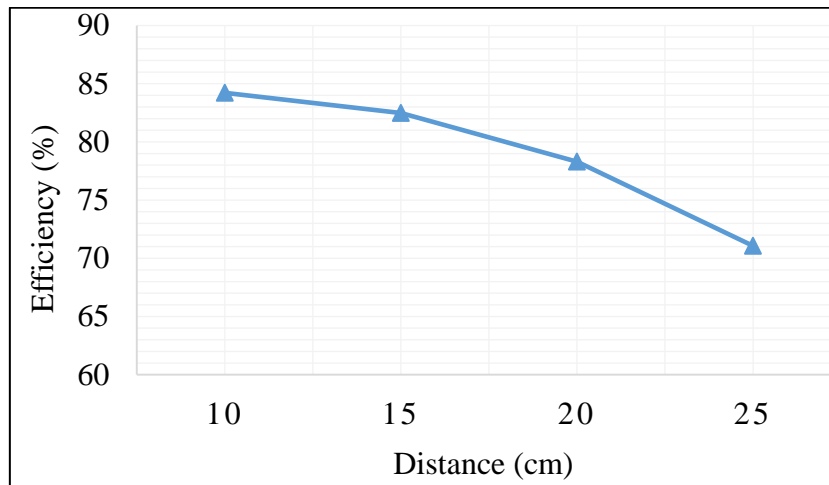


Figure 13. The system efficiency vs the distance between the coils.

## 5. Conclusions

In this study, an inductive wireless power transfer (IWPT) system that can be used in electric vehicles is designed. In the designed system, the shape of the primary and secondary coils is circular, and the radius is 25 cm. Initially, the 3D Maxwell model of the designed system was generated and then the Simplorer circuit was built. The operating frequency of the system is 20 KHz and the applied voltage is 100 volts. The distance between the coils in the generated model was taken as 10, 15, 20 and 25 cm and each case was investigated correspondingly. As a result of the investigations, it was shown that the coupling coefficient, mutual inductance, and efficiency of the system decreased as the distance between the coils increased. In future studies, it can be investigated whether systems with different coil shapes (rectangular, square, hexagonal, DDQ) will be more efficient or not. The effect of changes in the current system parameters (input voltage, number of turns, resonance frequency, load resistance) on system efficiency can also be investigated. In addition, it can be investigated how much the efficiency



**4TH INTERNATIONAL LATIN AMERICAN  
CONGRESS ON NATURAL AND APPLIED SCIENCES**

of the system will change if the outer surfaces of the primary and secondary coils are coated with ferrite strip and aluminum plate.

**References**

- [1] Green, A. W., & Boys, J. T. (1994). 10 kHz inductively coupled power transfer-concept and control. 1994 Fifth International Conference on Power Electronics and Variable-Speed Drives. 26-28 October 1994. London, UK. doi: 10.1049/cp:19941049
- [2] Afridi K. (2018). Wireless charging of electric vehicles. National Academy of Engineering. In *Frontiers of Engineering: Reports on Leading-Edge Engineering from the 2017 Symposium*. Washington, DC: The National Academies Press. September 25-27. doi: <https://doi.org/10.17226/24906>.
- [3] Garcia, X. D. T., Vazquez, J., & Roncero-Sánchez, P. (2015). Design, implementation issues and performance of an inductive power transfer system for electric vehicle chargers with series-series compensation. *IET Power Electronics*, 8(10), 1920-1930.
- [4] Minnaert, B., & Stevens, N. (2018). Maximizing the power transfer for a mixed inductive and capacitive wireless power transfer system. In *2018 IEEE Wireless Power Transfer Conference (WPTC)*. Canada. doi: 10.1109/WPT.2018.8639265
- [5] Wang, C. S., Covic, G. A., & Stielau, O. H. (2001). General stability criterions for zero phase angle controlled loosely coupled inductive power transfer systems. In *IECON'01. 27th Annual Conference of the IEEE Industrial Electronics Society*. USA. 1049-1054. DOI: 10.1109/IECON.2001.975925
- [6] Trivino-Cabrera, A., Gonzalez-Gonzalez, J. M., & Aguado, J. A. (2020). *Wireless power transfer for electric vehicles: foundations and design approach*, Springer.
- [7] Sallan, J., Villa, J. L., Llombart, A., & Sanz, J. F. (2009). Optimal design of ICPT systems applied to electric vehicle battery charge. *IEEE Transactions on Industrial Electronics*, 56(6), 2140-2149. doi: 10.1109/TIE.2009.2015359
- [8] Villa, J. L., Sallan, J., Osorio, J. F. S., & Llombart, A. (2011). High-misalignment tolerant compensation topology for ICPT systems. *IEEE Transactions on Industrial Electronics*, 59(2), 945-951. doi: 10.1109/TIE.2011.2161055
- [9] Budhia, M., Boys, J. T., Covic, G. A., & Huang, C. Y. (2013). Development of a single-sided flux magnetic coupler for electric vehicle IPT charging systems. *IEEE Transactions on Industrial Electronics*, 60(1), 318-328. doi: 10.1109/TIE.2011.2179274
- [10] Zheng, C., Ma, H., Lai, J. S., & Zhang, L. (2015). Design considerations to reduce gap variation and misalignment effects for the inductive power transfer system. *IEEE Transactions on Power Electronics*, 30(11), 6108-6119.

**ELECTRICAL AND STRUCTURAL CHARACTERIZATION OF PBS THIN FILMS  
PRODUCED BY SPRAY METHOD**

**Fatma MEYDANERİ TEZEL**

Prof. Dr., Karabük University  
ORCID No: 0000-0003-1546-875X

**ABSTRACT**

Lead sulfide is a semiconductor material used in diverse applications. They exhibit excellent special features for diverse applications such as LEDs, IR detectors and lasers, solar energy frameworks, optical fibers, window coverings through to the selective sensitivity of  $Pb^{+2}$  ions. Owing to the wide exciton and effective Bohr radius (18 nm) of cubic crystalline PbS, its absorption from the infrared (IR) to the visible region is quite effective. Due to the quantum limitations of the carriers, it has also strengthened the non-linear optical feature, which can be used as an optical code in optical equipments.

In this research, PbS films were turned out on glass substrates heated at 150 °C using the spray method. Depending on the 1, 2 and 3 spray numbers of the films, the grain sizes, dislocation intensities, crystallization numbers per unit area and lattice strains were found to be 16.57 nm, 14.66 nm, 13.73 nm;  $3.64 \times 10^{-3}$  line/nm<sup>2</sup>,  $4.65 \times 10^{-3}$  line/nm<sup>2</sup>,  $5.30 \times 10^{-3}$  line/nm<sup>2</sup>;  $18.66 \times 10^{-2}$  (1/nm<sup>2</sup>),  $80.01 \times 10^{-2}$  (1/nm<sup>2</sup>),  $114.30 \times 10^{-2}$  (1/nm<sup>2</sup>);  $7.91 \times 10^{-3}$ ,  $9.52 \times 10^{-3}$  and  $9.21 \times 10^{-3}$ , respectively. The electrical resistivity values were calculated with the four-point probe method. Depending on the number of 1, 2 and 3 sprays, the electrical resistivity values were calculated as  $8.20 \times 10^{-6}$  Ωcm,  $4.20 \times 10^{-6}$  Ωcm and  $2.48 \times 10^{-6}$  Ωcm, respectively.

**Keywords:** PbS, Thin film, spray method, electrical resistivity, lattice strain, grain size, dislocation density

**INTRODUCTION**

If electronic and optoelectronic devices have perfect crystal structures, their performance is also quite good (Yücel & Yücel, 2022; Pawar et al., 2011). However, the growth of crystals requires a complicated production operate with up procurement expenditures due to ultra-vacuum technologies such as MOCVD and MBE (Brahlek et al., 2018; Qin et al., 2022). On the other hand, semiconductor thin films synthesized with falling expenditure, facile and industrial scale production have significant advantages (Jung et al., 2015; Qin et al., 2022). However, due to a large scale of irregularly structured states such as grain boundary defects, they usually occur in polycrystalline structures (Hirth, 1974; Choi et al., 2009). Eventually, the far-scale array and periodic potential zone of polycrystalline thin films seriously impair photonic and electrical properties (Najmaei et al., 2014). It is therefore important to

understand purposeful scholarly and tech problems on how to enhance crystal grade to achieve brilliant electronic and optoelectronic properties.

Colloidal PbS quantum dots (Ellingson et al., 2005) have majority carriers due to sufficient multi-exciton generation and high state density (Nair et al., 2008; Pijpers et al., 2009). With its striking photonic and optoelectronic special features such as direct narrow band structure (0.4 eV) (Wu et al., 2019; Miller et al., 2016), PbS is very interesting as a short wave infrared semiconductor at room temperature. In addition, it has technological importance in many areas such as infrared detectors (Liu et al., 2009; Kim et al., 2020), solar cells (Günes et al., 2007; Zhao et al., 2010), gas sensors (Fu, 2009), diode lasers Ralston et al., 1974). Latterly, PbS thin films have been put out by diverse practices incorporating chemical bath deposition and sequential ionic thickness suction and reactions (Patil et al., 2006; Puišo et al., 2003; Preobrajenski & Chasse, 1999). However, electronic conduction attributions of thin films in chemical synthesis technics deteriorate due to inappropriate chemical pollution from organic reagents. However, despite single-crystalline PbS thin films have been prospered with MBE Preobrajenski & Chasse, 1999), they are quite expensive and complex. In addition, PbS thin films can be produced with distinct production mechanisms such as chemical bath deposition (CBD) (Bai et al., 2017; Liu et al., 2019), spray pyrolysis (Salah et al., 2005; Sarica & Bilgin, 2017), electrodeposition (Ikhioya et al., 2018), evaporation (Cheragizade et al., 2014), sputtering (Guozheng et al., 2014). Therefore, low-cost, clean and convenient synthesis technologies for preparing PbS thin films with high crystal quality remain fascinating.

In this work, PbS films were fabricated on glass substrates heated at 150 °C using the spray method. Depending on the 1, 2 and 3 spray numbers of the films, the grain sizes, dislocation densities, crystallization numbers per unit area, lattice strains and electrical resistivity values were investigated.

## **EXPERIMENTAL PROCEDURE**

In 2 separate beakers, 1.044 g of PbNO<sub>3</sub> and 0.648 g of NaOH were dissolved in 10 ml of distilled water for 10 minutes with the help of a magnetic stirrer. Then, the contents of these two beakers were mixed in a 50 ml beaker and the blend was allowed to become homogeneous for 10 minutes. Again in a separate beaker, 0.73 g of thiourea was dissolved in 10 ml of distilled water with a magnetic stirrer for 10 minutes and added to the solution in a 50 ml beaker. The solution was stirred on a magnetic stirrer for about 10 min until the colorway of the dissolution changed to dark gray. When the glass substrates placed on the heater are at 150 °C, The films were deposited with air gas by adjusting to be 10 cm the length between the substrate and the nozzle at a right angle to the surface for spraying amount of 1, 2 and 3. In this method, parameters such as the temperature of the substrate, the amount of spraying and the thickness of the film affect the quality of the film.

The structured qualities of the PbS thin films were explored by XRD and the surface morphologies were analyzed by FESEM. The thickness of the films was evaluated with the Mitutoya SurfTest Ver2.00 device. Electrical resistivity values were computed from current-voltage (I-V) estimates in the range of -0.3 to 0.7 volts with Keithley 2400 sourcemeter and Keithley 2100/220 Multimeter in dark environment at room temperature by taking 1 mm between contacts.

**RESULTS AND DISCUSSION**

XRD diffraction figures of PbS thin films for spray amount 1, 2 and 3 are given in Figure 1. Since it is sprayed with air gas, there is also a low-intensity PbSO<sub>4</sub> structure inside the structure. The strongest peak is observed at 30.17° (2 0 0 ) (PDF Card No.: 00-002-0699) in the cubic structured orientation. Average grain sizes (D) were calculated over the strongest peak with Scherrer's equation (Eq.1).

$$D = \frac{0.9\lambda}{\beta \cos\theta} \tag{1}$$

Where  $\lambda$ ,  $\theta$ ,  $\beta$  are the wavelength of used X-ray, Bragg angle and angular line width at half-maximum intensity in radians, respectively. The dislocation density ( $\delta$ ) was calculated by (Eq.2).

$$\delta = \frac{1}{D^2} \tag{2}$$

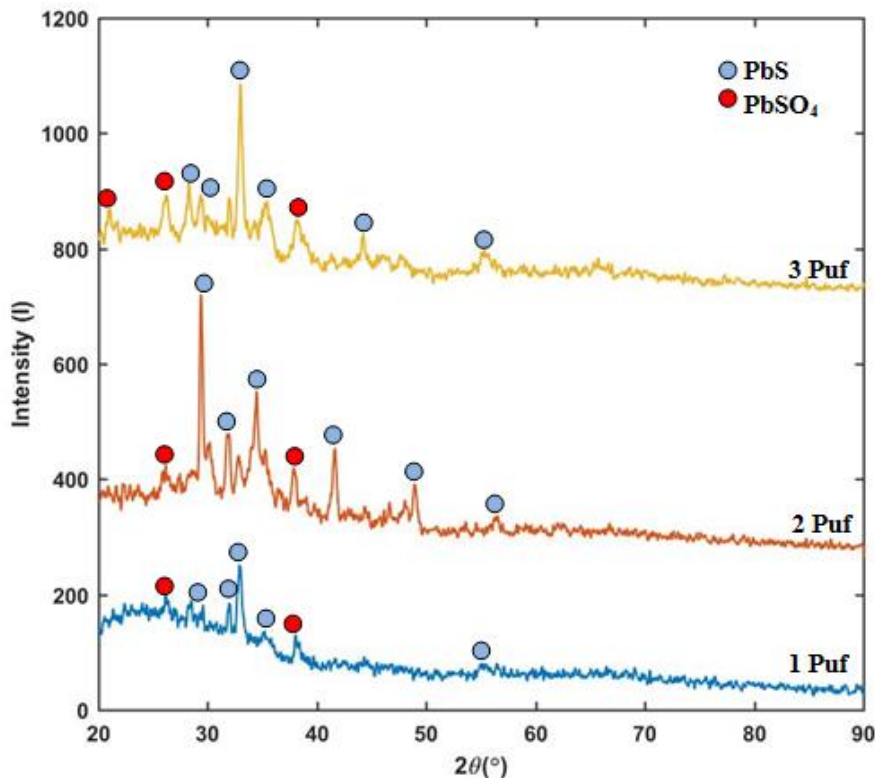
The number of crystals per unit area (N) is obtained by using (Eq.3).

$$N = \frac{t}{D^3} \tag{3}$$

where t represents the thickness of the film.

Lattice Strain ( $\varepsilon$ ) is calculated with (Eq.4).

$$\varepsilon = \frac{\beta \cot\theta}{4} \tag{4}$$





**4TH INTERNATIONAL LATIN AMERICAN  
CONGRESS ON NATURAL AND APPLIED SCIENCES**

Figure 1. XRD figures of PbS thin films depend on spray amount.

Depending on the 1, 2 and 3 spray numbers of the films, the grain sizes, dislocation intensities, crystallization numbers per unit area and lattice strains were ascertained to be 16.57 nm, 14.66 nm, 13.73 nm;  $3.64 \times 10^{-3}$  line/nm<sup>2</sup>,  $4.65 \times 10^{-3}$  line/nm<sup>2</sup>,  $5.30 \times 10^{-3}$  line/nm<sup>2</sup>;  $18.66 \times 10^{-2}$  (1/nm<sup>2</sup>),  $80.01 \times 10^{-2}$  (1/nm<sup>2</sup>),  $114.30 \times 10^{-2}$  (1/nm<sup>2</sup>);  $7.91 \times 10^{-3}$ ,  $9.52 \times 10^{-3}$  and  $9.21 \times 10^{-3}$ , respectively. The values obtained in this study are quite compatible with the PbS thin films fabricated by the spray pyrolysis tech by Chandekar et al. (Chandekar et al., 2022).

Depending on the 1, 2 and 3 spray numbers of the films, FESEM images are given in Figure 2. Accordingly, the films for 1 and 2 sprays show a very dense and homogeneous surface morphology. For 3 spray, the dislocation density increased and gaps were formed in places.

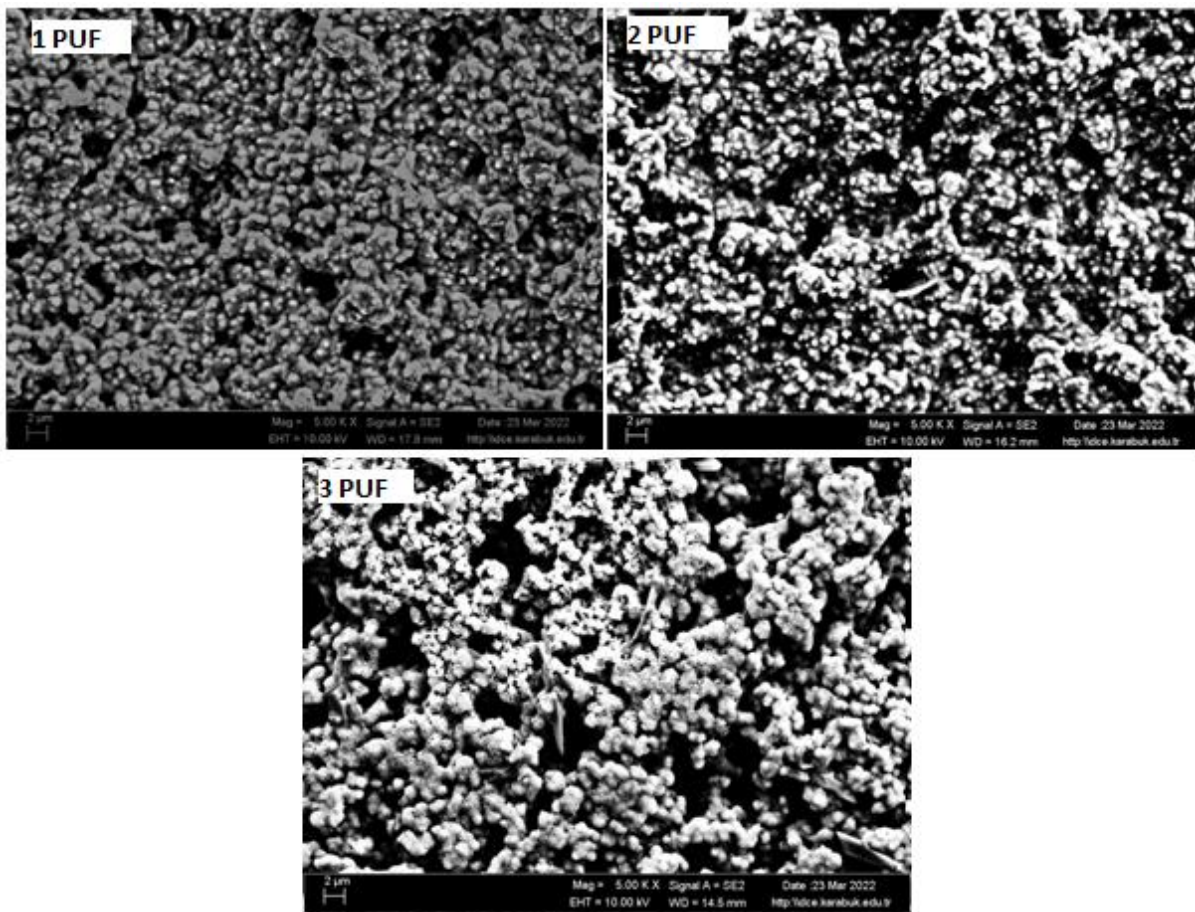


Figure 2. FESEM images of PbS thin films.

The electrical resistivity values were obtained with the four-point probe method and (Eq. 5).

$$\rho = \frac{\pi t}{\ln 2} \left( \frac{V}{I} \right) \quad (5)$$

Here, V, I and t demonstrate the potential difference, current and film thickness, respectively. In order to calculate the electrical resistivity values, the film thicknesses's were computed with the Mitutoya SurfTest Ver2.00 device. The film thicknesses were measured as 849 nm, 2521 nm and 2960 nm for 1, 2 and 3 sprays, respectively. As the number of sprays increased, the film thickness also increased, as depicted in Figure 3. The current-voltage (I-V) graphs of

**4TH INTERNATIONAL LATIN AMERICAN  
CONGRESS ON NATURAL AND APPLIED SCIENCES**

the films are given in Figure 4. Depending on the number of 1, 2 and 3 sprays, and the electrical resistivity values were calculated as  $8.20 \times 10^{-6} \Omega\text{cm}$ ,  $4.20 \times 10^{-6} \Omega\text{cm}$  and  $2.48 \times 10^{-6} \Omega\text{cm}$ , respectively. As the film thickness increases, the electrical resistivity values decrease and the electrical conductivity increases.

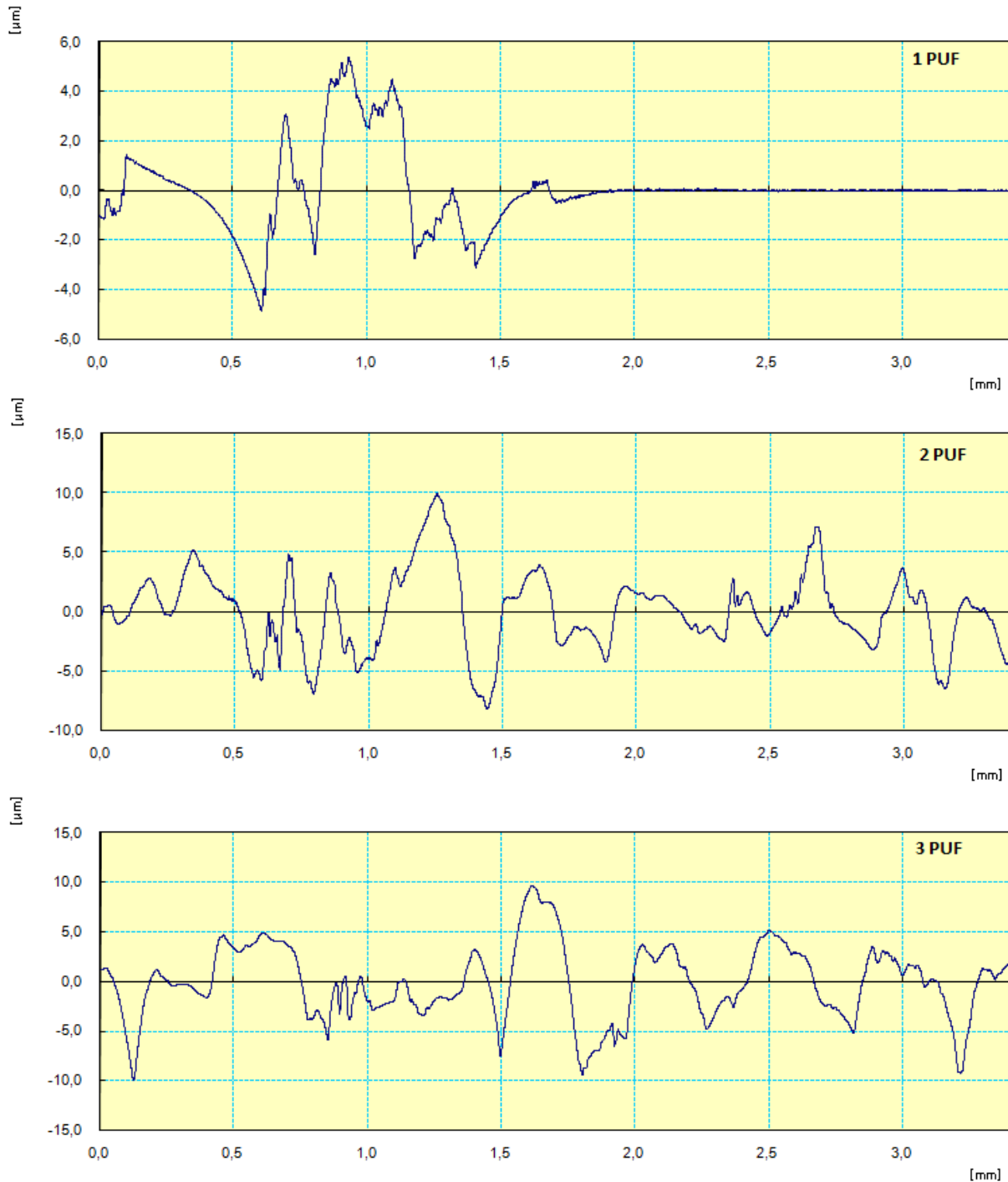


Figure 3. Film thicknesses of PbS thin films for 1, 2 and 3 sprays.



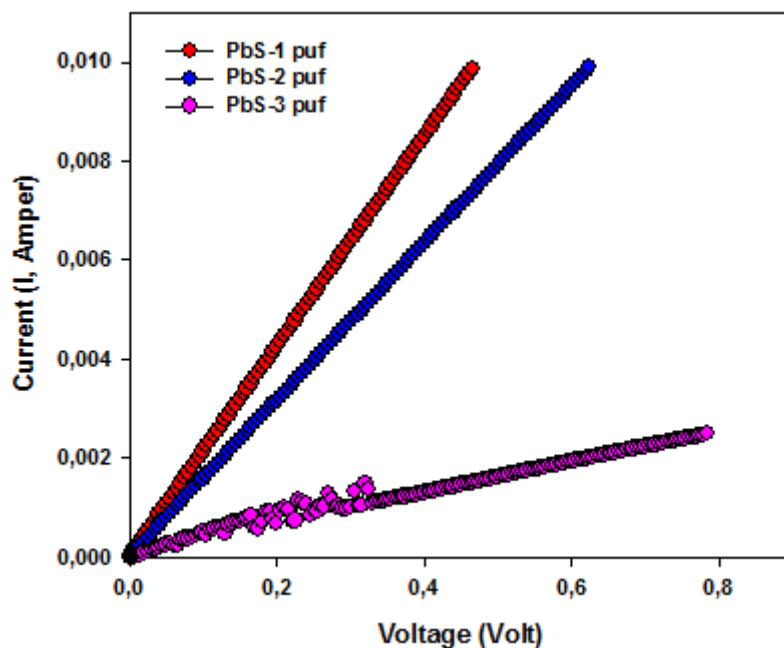


Figure 4. I-V curves of PbS thin films for 1, 2 and 3 sprays.

## CONCLUSION

In this work, PbS thin films were produced depending on the amount of spray. It has been found that the increment in film thickness depending on the topological surfaces of the prepared films affects the structural and electrical properties. Increasing the number of sprays triggered the formation of more disorder structures. These microstructural irregularities led to the excitation of microstrains, resulting in an increase and a decrease in grain size. With the increase of film thickness, it showed typical semiconductor properties and its electrical conductivity increased. The increase in electrical conductivity with film thicknesses contributed little to the scattering of carriers from the surface and grain boundaries of the film. The resulting PbS thin films can be used in solar energy collectors, selective surface devices, IR and near-IR detectors, and optoelectronic devices.

## REFERENCES

- Bai, R., Kumar, D., Chaudhary, S., & Pandya, D. K. (2017). Highly crystalline p-PbS thin films with tunable optical and hole transport parameters by chemical bath deposition. *Acta Materialia*, 131, 11-21.
- Brahlek, M., Gupta, A. S., Lapano, J., Roth, J., Zhang, H. T., Zhang, L., ... & Engel-Herbert, R. (2018). Frontiers in the growth of complex oxide thin films: past, present, and future of hybrid MBE. *Advanced Functional Materials*, 28(9), 1702772.
- Chandekar, K. V., Alkallas, F. H., Trabelsi, A. B. G., Shkir, M., Hakami, J., Khan, A., ... & AlFaify, S. (2022). Improved linear and nonlinear optical properties of PbS thin films synthesized by spray pyrolysis technique for optoelectronics: An effect of Gd<sup>3+</sup> doping concentrations. *Physica B: Condensed Matter*, 641, 414099.

**4TH INTERNATIONAL LATIN AMERICAN  
CONGRESS ON NATURAL AND APPLIED SCIENCES**

- Cheragizade, M., Yousefi, R., Jamali-Sheini, F., Mahmoudian, M. R., Sa, A., & Huang, N. M. (2014). Synthesis and characterization of PbS mesostructures as an IR detector grown by hydrogen-assisted thermal evaporation. *Materials science in semiconductor processing*, 26, 704-709.
- Choi, J., Jeong, H. K., Snyder, M. A., Stoeger, J. A., Masel, R. I., & Tsapatsis, M. (2009). Grain boundary defect elimination in a zeolite membrane by rapid thermal processing. *Science*, 325(5940), 590-593.
- Ellingson, R. J., Beard, M. C., Johnson, J. C., Yu, P., Micic, O. I., Nozik, A. J., ... & Efros, A. L. (2005). Highly efficient multiple exciton generation in colloidal PbSe and PbS quantum dots. *Nano letters*, 5(5), 865-871.
- Fu, T. (2009). Research on gas-sensing properties of lead sulfide-based sensor for detection of NO<sub>2</sub> and NH<sub>3</sub> at room temperature. *Sensors and Actuators B: Chemical*, 140(1), 116-121.
- Guozheng, M., Binshi, X., Haidou, W., Shuying, C., & Zhiguo, X. (2014). Excellent vacuum tribological properties of Pb/PbS film deposited by Rf magnetron sputtering and ion sulfurizing. *ACS Applied Materials & Interfaces*, 6(1), 532-538.
- Günes, S., Fritz, K. P., Neugebauer, H., Sariciftci, N. S., Kumar, S., & Scholes, G. D. (2007). Hybrid solar cells using PbS nanoparticles. *Solar Energy Materials and Solar Cells*, 91(5), 420-423.
- Hirth, J. P. (1974). Defect structures in grain boundaries. *Acta Metallurgica*, 22(8), 1023-1031.
- Ikhioya, I., Ehika, S., & Ijabor, B. (2018). Influence of deposition potential on lead sulphide (PbS) thin film using electrodeposition technique. *Asian. J. Chem. Sci.*[Online], 3(4), 1-8.
- Jung, C., Kim, S. M., Moon, H., Han, G., Kwon, J., Hong, Y. K., ... & Park, J. (2015). Highly crystalline CVD-grown multilayer MoSe<sub>2</sub> thin film transistor for fast photodetector. *Scientific reports*, 5(1), 15313.
- Kim, J., Ampadu, E. K., Oh, E., Choi, H., Ahn, H. Y., Cho, S. H., ... & Byun, J. Y. (2020). Photocurrent spectra for above and below bandgap energies from photovoltaic PbS infrared detectors with graphene transparent electrodes. *Current Applied Physics*, 20(3), 445-450.
- Liu, M., Zhan, Q., Li, W., Li, R., He, Q., & Wang, Y. (2019). Effect of Zn doping concentration on optical band gap of PbS thin films. *Journal of Alloys and Compounds*, 792, 1000-1007.
- Liu, Z., Kim, J. H., Fernandes, G. E., & Xu, J. (2009). Room temperature photocurrent response of PbS/InP heterojunction. *Applied Physics Letters*, 95(23), 231113.
- Miller, E. M., Kroupa, D. M., Zhang, J., Schulz, P., Marshall, A. R., Kahn, A., ... & Van De Lagemaat, J. (2016). Revisiting the valence and conduction band size dependence of PbS quantum dot thin films. *ACS nano*, 10(3), 3302-3311.

**4TH INTERNATIONAL LATIN AMERICAN  
CONGRESS ON NATURAL AND APPLIED SCIENCES**

- Nair, G., Geyer, S. M., Chang, L. Y., & Bawendi, M. G. (2008). Carrier multiplication yields in PbS and PbSe nanocrystals measured by transient photoluminescence. *Physical Review B*, 78(12), 125325.
- Najmaei, S., Amani, M., Chin, M. L., Liu, Z., Birdwell, A. G., O'Regan, T. P., ... & Lou, J. (2014). Electrical transport properties of polycrystalline monolayer molybdenum disulfide. *ACS nano*, 8(8), 7930-7937.
- Qin, L., Wu, S., Wang, J. G., Li, Q., Yuan, C., Wang, Z., ... & Wang, Q. (2022). Enhancement of infrared response speed via modulating crystallinity of highly-oriented PbS polycrystalline thin films. *Infrared Physics & Technology*, 121, 104033.
- Salah, H. B. H., Bouzouita, H., & Rezig, B. (2005). Preparation and characterization of tin sulphide thin films by a spray pyrolysis technique. *Thin Solid Films*, 480, 439-442.
- Sarica, E., & Bilgin, V. (2017). Effect of Pb: S molar ratio in precursor solution on the properties of lead sulphide thin films by ultrasonic spray pyrolysis. *Materials Science in Semiconductor Processing*, 71, 42-49.
- Patil, R. S., Pathan, H. M., Gujar, T. P., & Lokhande, C. D. (2006). Characterization of chemically deposited nanocrystalline PbS thin films. *Journal of materials science*, 41, 5723-5725.
- Pawar, S. M., Pawar, B. S., Kim, J. H., Joo, O. S., & Lokhande, C. D. (2011). Recent status of chemical bath deposited metal chalcogenide and metal oxide thin films. *Current Applied Physics*, 11(2), 117-161.
- Pijpers, J. J. H., Ulbricht, R., Tielrooij, K. J., Osharov, A., Golan, Y., Delerue, C., ... & Bonn, M. (2009). Assessment of carrier-multiplication efficiency in bulk PbSe and PbS. *Nature Physics*, 5(11), 811-814.
- Preobrajenski, A. B., & Chasse, T. (1999). Epitaxial growth and interface structure of PbS on InP (110). *Applied surface science*, 142(1-4), 394-399.
- Puišo, J., Lindroos, S., Tamulevičius, S., Leskelä, M., & Snitka, V. (2003). Growth of ultra thin PbS films by SILAR technique. *Thin Solid Films*, 428(1-2), 223-226.
- Ralston, R. W., Walpole, J. N., Calawa, A. R., Harman, T. C., & McVittie, J. P. (1974). High cw output power in stripe-geometry PbS diode lasers. *Journal of Applied Physics*, 45(3), 1323-1325.
- Wu, X., Kim, M., Qu, H., & Wang, Y. (2019). Single-defect spectroscopy in the shortwave infrared. *Nature Communications*, 10(1), 2672.
- Yücel, E., & Yücel, Y. (2022). Deposition of PbS thin films using a continuous flow reactor: Comparison of the modified technique with conventional methods in the coating of PbS thin film on the substrate. *Journal of the Indian Chemical Society*, 99(10), 100706.
- Zhao, N., Osedach, T. P., Chang, L. Y., Geyer, S. M., Wanger, D., Binda, M. T., ... & Bulovic, V. (2010). Colloidal PbS quantum dot solar cells with high fill factor. *ACS nano*, 4(7), 3743-3752.

**Prof. Dr., Fatma MEYDANERİ TEZEL**

Karabük University  
ORCID No: 0000-0003-1546-875X

**Prof. Dr. NECMİ SERKAN TEZEL**

Karabük University  
ORCID No: 0000-0002-9452-677X

## **ABSTRACT**

Developments in today's electronics world are directly related with advances in semiconductor material technologies. Electronic circuit elements produced using semiconductors have become a basic need in every aspect of human life. Semiconductor circuit elements are used in communication, medicine, informatics, automotive, transportation, military and many other fields. Systems realized using semiconductor; it has advantages such as being light, small, low error rate, economical and high efficiency.

In this study, PbS thin film electrode systems were obtained depending on the number of sprays on the substrates heated at 150 °C. The surface morphologies of these structures were determined by FESEM, compositional analyzes was determined by EDX mapping, and crystal structures were determined by XRD. Specific capacitance values (Cs) are measured the help of Keithley 2400 sourcemeter and 2100/220 Keithley multimeter using in-plane time-dependent I-V method with 10 mV/s, 25 mV/s, 50 mV/s and 100 mV/s scanning rates in the range of 0 to 1 volts for 1, 2 and 3 sprays. Accordingly, the amount of mass coated for 1, 2 and 3 sprays was weighed as  $2.27 \times 10^{-3}$  g,  $13.5 \times 10^{-3}$  g and  $23 \times 10^{-3}$  g, respectively. It is seen that the Cs valuations decline with increasing scanning rate and the quantity of plating mass. Cs valuations were obtained as 923 F/g, 725 F/g and 524 F/g, respectively, at the least scanning rate 10 mV/s for 1, 2 and 3 times spraying.

**Key Words:** Lead sulfide, Thin-film, Supercapacitor Electrode, Specific Capacitance

## **INTRODUCTION**

Chalcogenites are materials including one or more chalcogen elements. It is from the oxygen group in the 16th column of the periodic table. It contains the elements oxygen, sulfur, selenium, tellurium and polonium (O, S, Se, Te and Po). They have 6 valence electrons and are -2 valences (Chopra&Kaur, 1983; George, 1992; Rossnagel, 2003; Pickart, 1970). This group of elements exhibits metal properties as their atomic number scale up. Oxygen and sulfur are nonmetals, selenium and tellurium are metalloids, and polonium is a metal. The bonding distinctives of these elements are latitude to the metal properties. These elements are

## **4TH INTERNATIONAL LATIN AMERICAN CONGRESS ON NATURAL AND APPLIED SCIENCES**

covalently bonded materials and can have amorphous or crystalline structure. They are basic semiconductors with a band gap of 1-2 eV dependent on their components. Although chalcogenides have potential disadvantages for some applications, they are potent and have significant advantages for printing structures in fibers. Also, they are glassy semiconductors with interesting electrical properties. Metal chalcogenide semiconductors play an assets role as absorber layer for thin-film photovoltaic equipments, so the scholarly committee is interested in optoelectronic and energy devices because of their multifunctional properties (Putley & Arthur, 1951). Among the IV-VI compound semiconductors, PbS has an FCC cubic rock salt crystal structure. PbS is an essential semiconductor with a direct narrow band structure and a Bohr radius of 18 nm with an energy band gap of about 0.4 eV at 300 K (Smith, 2002; Bunshah, 1994; Ibragimova et al., 2018; Karazhanov et al., 2000). They exhibit striking features making them appropriate for a variety of applications as LEDs, IR detectors and lasers, solar power regulations, optical fibers, window coverings (Ni et al., 2004; Peterson & Krauss, 2006).

Flexibility and size are enabled in design devices for specific applications. This thin-film practice is even more essential in today's solid-state industrial, CDs, disk drives, and optical device industrials. Thin film technology consisting of metal oxides, metal chalcogenides and transition metal oxides is important in semiconductor research fields and coating applications (Sahadevan et al., 2022). Different storage techniques including chemical bath deposition (CBD), spray pyrolysis, electrodeposition, evaporation and sputtering (Uhler & Helz, 1984; Salah et al., 2005; Sharon et al., 1997; Kumar et al., 2003; Martinet al., 1982) have been used to fabricate PbS thin films. In this work, the spray method was used because of its low cost, suitable for large area coatings, low functional temperature and easy usability of the devices.

### **EXPERIMENTAL SECTION**

In 10 ml distilled water, 0.01 Molar  $\text{PbNO}_3$  and 0.15 Molar NaOH were dissolved in 2 separate beakers with the help of a magnetic stirrer for 10 minutes. Then, the contents of these two beakers were stirred in a 50 ml beaker and the blend was allowed to become homogeneous for 10 minutes. In a separate beaker, 0.05 Molar thiourea  $[(\text{NH}_2)_2\text{CS}]$  was dissolved in 10 ml of ultra pure water with a magnetic stirrer for 10 minutes and added to the dissolution in the 50 ml beaker. The dissolution was mixed on a magnetic stirrer for approximately 10 min till the color of the dissolution changed to dark gray. When the glass substrates placed on the heater are at 150 °C, The films were deposited with air gas by adjusting to be 10 cm the length between the substrate and the nozzle at a right angle to the surface for spraying amount of 1, 2 and 3.

The surface morphologies of these structures were imaged by FESEM, compositional analyzes was determined by EDX mapping, and crystal structures were obtained by XRD. Specific capacitance values are measured the help of Keithley 2400 sourcemeter and 2100/220 Keithley multimeter using in-plane time-dependent I-V method with 10 mV/s, 25 mV/s, 50 mV/s and 100 mV/s scanning rates in the range of 0 to 1 volts for 1, 2 and 3 sprays.

**RESULTS AND DISCUSSION**

Depending on the 1, 2 and 3 spray amounts of the films, XRD patterns are given in Figure 1 and structural parameters are given in Table 1.

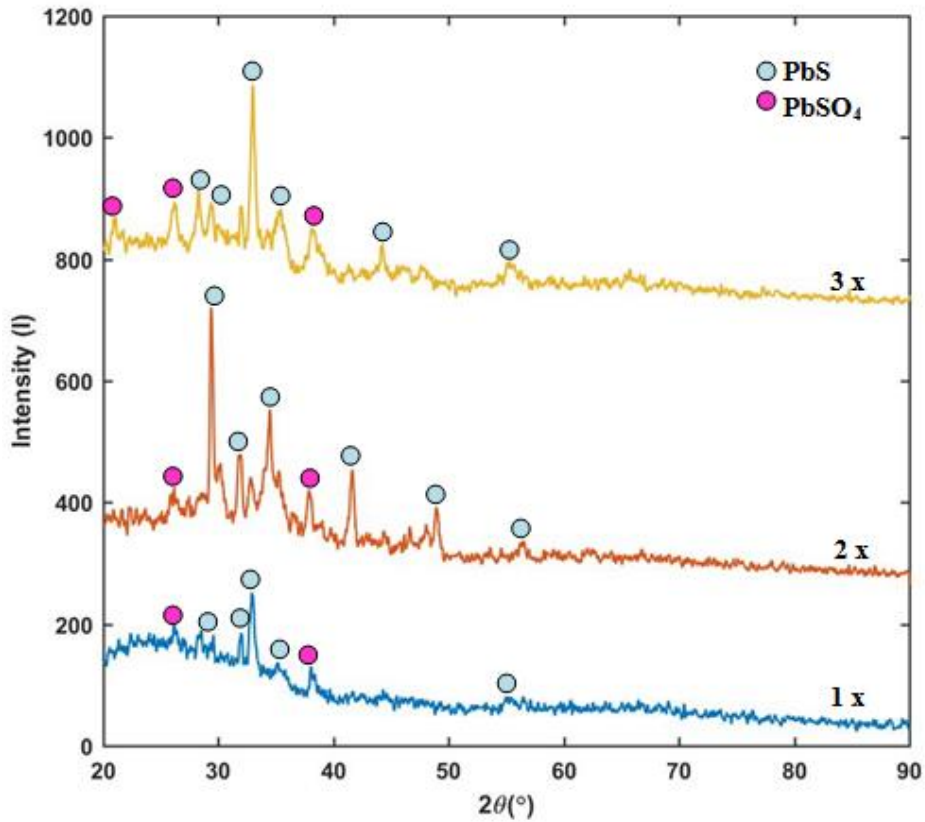


Figure 1. XRD patterns of PbS thin films depend on spray amount.

Table 1. Crystal Parameters of PbS thin films.

Crystal Structures	Diffraction Angle $2\theta$ (°)	Miller Index (h k l)	Distance Plane d (Å)
PbS (PDF Card No.: 00-002-0699)	26,03	( 1 1 1 )	3.420
	30.17	( 2 0 0 )	2.960
	43.47	( 2 2 0 )	2.080
	50.98	( 3 1 1 )	1.790
	53.55	( 2 2 2 )	1.710
PbSO4 (PDF Card No.: 00-001-0867)	20.83	( 0 1 1 )	4.260
	26.75	( 2 1 0 )	3.330
	37.44	( 2 1 2 )	2.400

Accordingly, the films for 1 and 2 sputtering show a very dense and homogeneous surface morphology (Figure 2). There are no cracks on the film surfaces. They have small spherical shapes. There are gaps in the intermediate regions of the film for 3 sprays. Since the grain sizes of the films are small, composition analyzes were performed with EDX mapping on a black background and are depicted in Figure 3.



4TH INTERNATIONAL LATIN AMERICAN  
CONGRESS ON NATURAL AND APPLIED SCIENCES

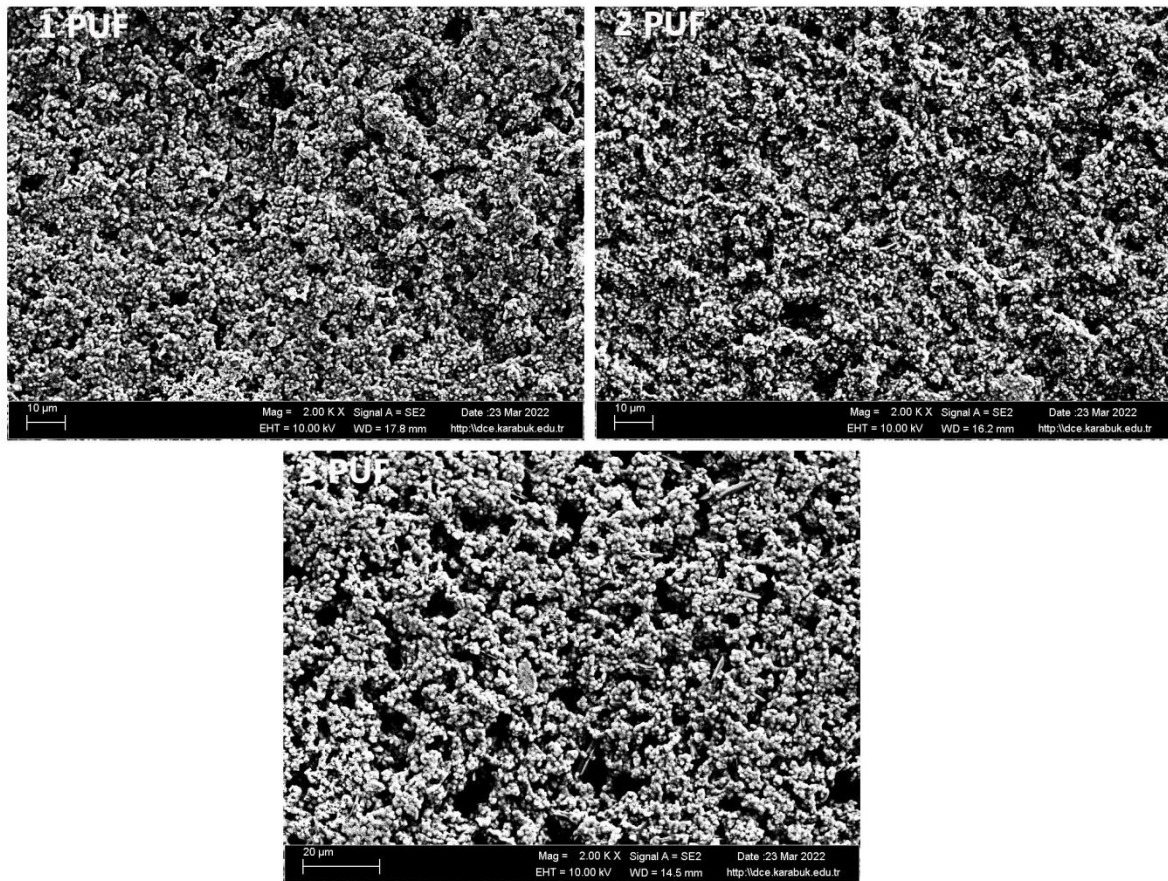
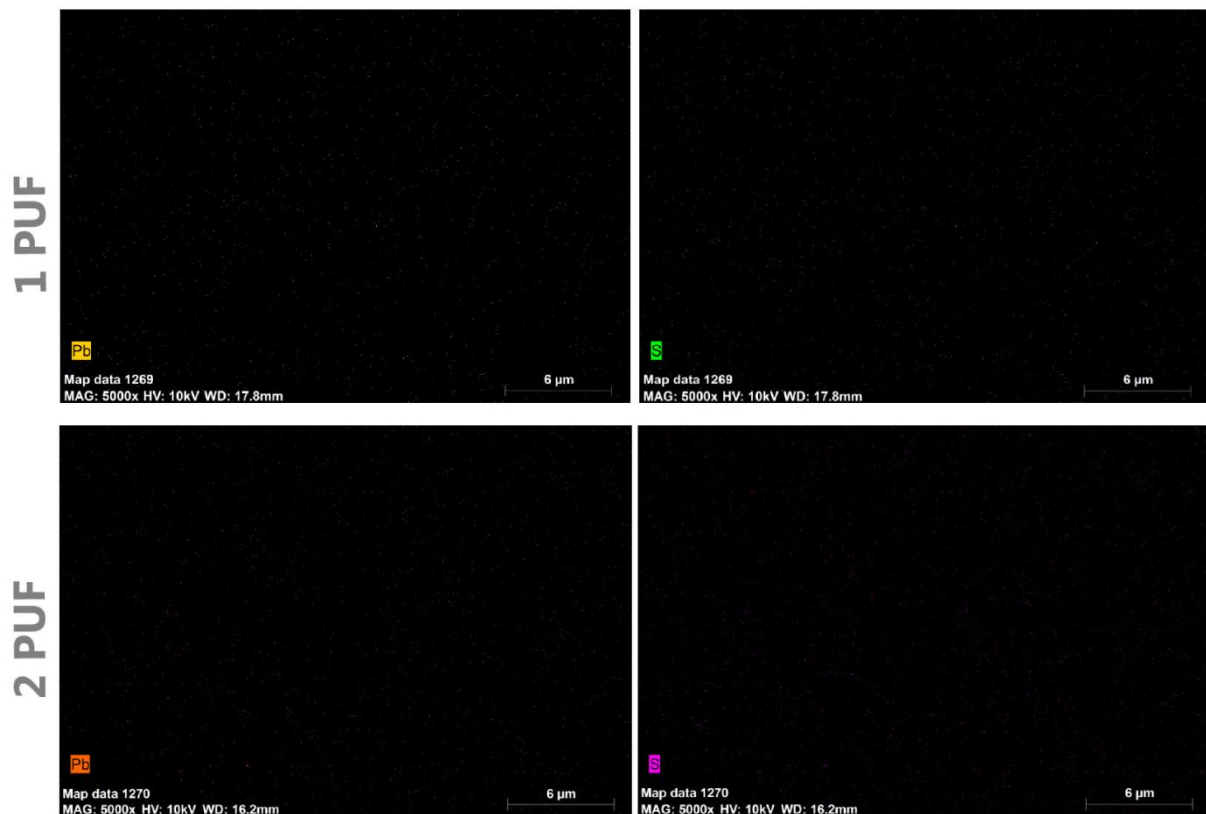


Figure 2. FESEM displays of PbS thin films.



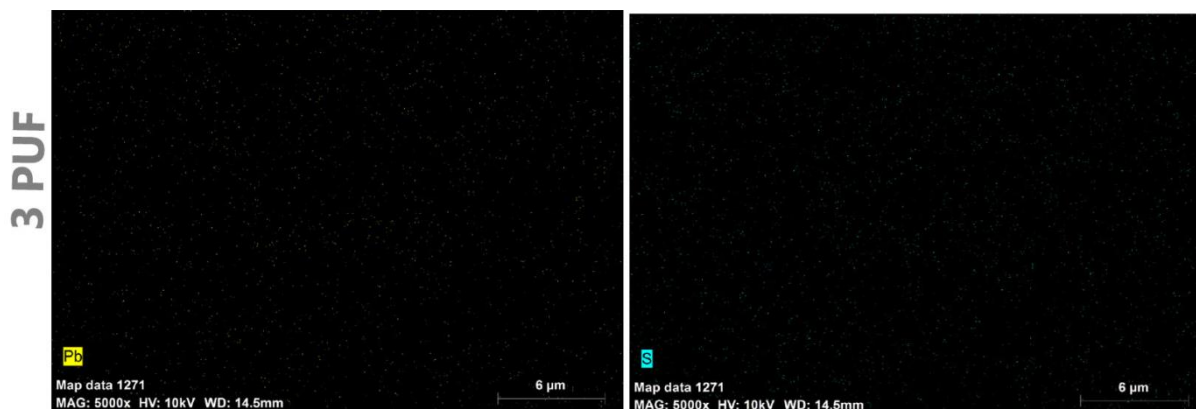


Figure 3. EDX mappings of PbS thin films depends on spray amount.

The substrates were weighed with a precision balance before and after the films were coated, and the quantity of plating mass was determined. Cs valuations are measured the help of Keithley 2400 sourcemeter and 2100/220 Keithley multimeter using in-plane time-dependent I-V modus with 10, 25, 50 and 100 mV/s scanning between 0 - 1 volts for 1, 2 and 3 sprays by

Kickstart program. Whole evaluations were acquired at room temp and in the dark. The specific capacitance values were calculated with the help of Eq.1 by using the amount of coated mass.

$$C_s = \frac{I}{m \cdot \frac{dV}{dt}} \quad (1)$$

where  $C_s$  is capacitance (F/g),  $I$  is current (A),  $m$  is quantity of coated film (g). Accordingly, the amount of mass coated for 1, 2 and 3 sprays was weighed as  $2.27 \times 10^{-3}$  g,  $13.5 \times 10^{-3}$  g and  $23 \times 10^{-3}$  g, respectively. For 1, 2 and 3 times spraying, the cyclic voltammetry curves depending on the scanning rates and the variance of the  $C_s$  are given in Figures 4 and 5, respectively. It is observed that the  $C_s$  valuations decline with increasing scanning rate and the quantity of plating mass.  $C_s$  valuations were obtained as 923 F/g, 725 F/g and 524 F/g, respectively, at the least scanning rate 10 mV/s for 1, 2 and 3 times spraying. Durga et al. (Durga et al., 2018) found specific capacitance values between 248.48 F/g and 41.4 F/g for PbS supercapacitor electrodes synthesized on Ni foam by chemical bath deposition method, which is also consistent with the values obtained in this study.

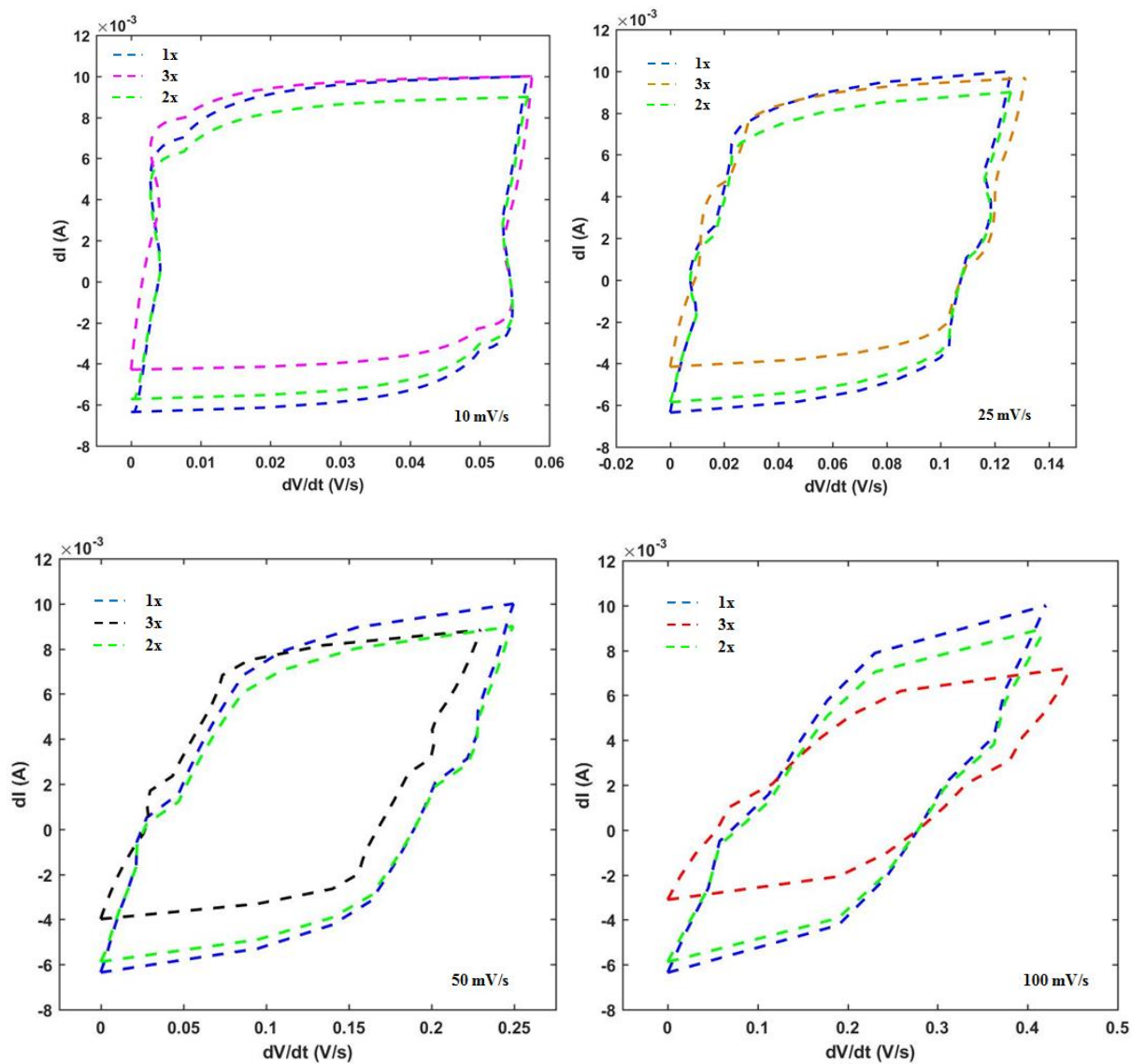


Figure 4. Cyclic voltammetry curves of PbS thin film electrode structures depend on scanning rate.

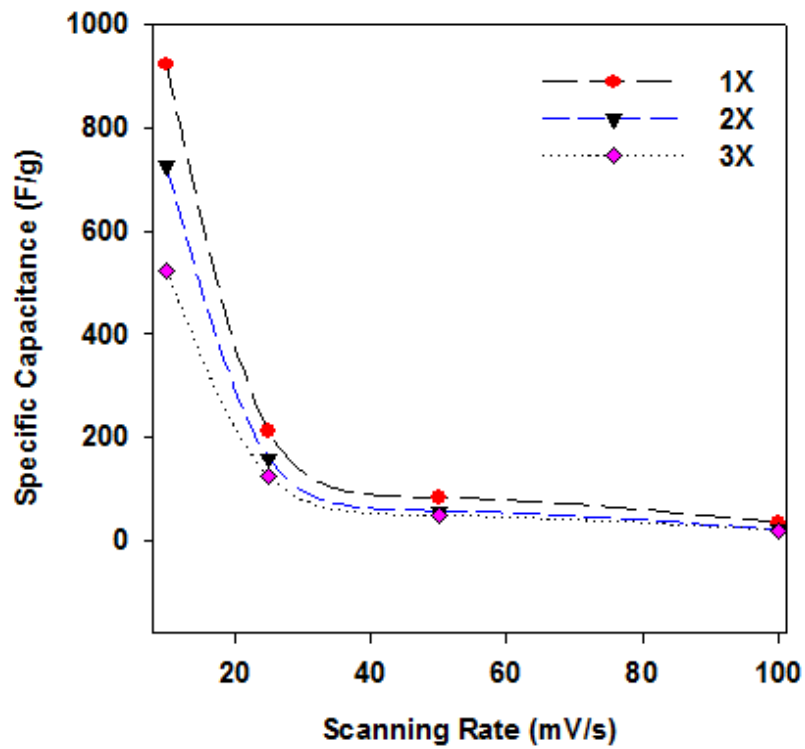


Figure 5. Specific capacitance curves of PbS thin film electrode structures depend on scanning rate.

**4TH INTERNATIONAL LATIN AMERICAN  
CONGRESS ON NATURAL AND APPLIED SCIENCES**

Table 2. Specific capacitance values for PbS thin film electrode structures.

1 PUF	Scan Rate (mV/s)	C, Specific Capacitance (F/g)
	10	923
	25	211
	50	82.3
	100	33.9
2 PUF	Scan Rate (mV/s)	C, Specific Capacitance (F/g)
	10	725
	25	159
	50	56.9
	100	20.2
3 PUF	Scan Rate (mV/s)	C, Specific Capacitance (F/g)
	10	524
	25	123
	50	47.8
	100	19.7

**CONCLUSION**

In this study, PbS thin film electrode samples were fabricated by spray method, which is easy, inexpensive, does not require much equipment and suitable for large-scale coatings, depending on the amount of spray on glass substrates at 150 °C. Surface morphologies appear quite dense and homogeneous. A small amount of PbSO<sub>4</sub> crystal structures were also formed due to the production with air. With the increase of the spray number, the amount of coated mass increased and with the increase of the scanning speed, the specific capacitance values decreased because only the surface charges were active. Due to the high carrier density of the PbS chalcogenite structure, high performance supercapacitors with low cost, low toxicity, environmentally friendly, appropriate size and morphology can be obtained and improved with additives.

**REFERENCES**

Bunshah, R. F. (Ed.). (1994). Handbook of deposition technologies for films and coatings: science, technology, and applications. William Andrew.

Chopra, K. L., & Kaur, I. (1983). Microelectronic Applications. Thin Film Device Applications, 129-170.

George, J. (1992). Preparation of thin films. CRC Press.



**4TH INTERNATIONAL LATIN AMERICAN  
CONGRESS ON NATURAL AND APPLIED SCIENCES**

- Ibragimova, R., Ganchenkova, M., Karazhanov, S., & Marstein, E. S. (2018). First-principles study of SnS electronic properties using LDA, PBE and HSE06 functionals. *Philosophical Magazine*, 98(8), 710-726.
- Kanaka Durga, I., Srinivasa Rao, S., Ahn, J. W., Park, T. Y., Jin-Soo, B., Ho, C. I., ... & Kim, H. J. (2018). Dice-like nanostructure of a CuS@ PbS composite for high-performance supercapacitor electrode applications. *Energies*, 11(7), 1624.
- Kumar, S., Sharma, T. P., Zulfequar, M., & Husain, M. (2003). Characterization of vacuum evaporated PbS thin films. *Physica B: Condensed Matter*, 325, 8-16.
- Karazhanov, S. Z., Zhang, Y., Mascarenhas, A., & Deb, S. (2000). The effect of excitons on CdTe solar cells. *Journal of Applied Physics*, 87(12), 8786-8792.
- Martin, P. J., Netterfield, R. P., & Sainty, W. G. (1982). Spectrally selective PbS films produced by ion beam sputtering. *Thin Solid Films*, 87(3), 203-206.
- Ni, Y., Liu, H., Wang, F., Liang, Y., Hong, J., Ma, X., & Xu, Z. (2004). PbS crystals with clover-like structure: Preparation, characterization, optical properties and influencing factors. *Crystal Research and Technology: Journal of Experimental and Industrial Crystallography*, 39(3), 200-206.
- Peterson, J. J., & Krauss, T. D. (2006). Fluorescence spectroscopy of single lead sulfide quantum dots. *Nano letters*, 6(3), 510-514.
- Pickart, S. J. (1970). Physical properties of sulfide materials. *Mineral. Soc. Amer. Spec. Rep*, 3, 145-153.
- Putley, E. H., & Arthur, J. B. (1951). Lead Sulphide-An Intrinsic Semiconductor. *Proceedings of the Physical Society. Section B*, 64(7), 616.
- Rossnagel, S. M. (2003). Thin film deposition with physical vapor deposition and related technologies. *Journal of Vacuum Science & Technology A: Vacuum, Surfaces, and Films*, 21(5), S74-S87.
- Sahadevan, J., Muthu, S. E., Kulathuraan, K., Arumugam, S., Kim, I., Pratha, G. B. S., & Sivaprakash, P. (2022). Structural, morphology and optical properties of PbS (Lead Sulfide) thin film. *Materials Today: Proceedings*, 64, 1849-1853.
- Salah, H. B. H., Bouzouita, H., & Rezig, B. (2005). Preparation and characterization of tin sulphide thin films by a spray pyrolysis technique. *Thin Solid Films*, 480, 439-442.
- Sharon, M., Ramaiah, K. S., Kumar, M., Neumann-Spallart, M., & Levy-Clement, C. (1997). Electrodeposition of lead sulphide in acidic medium. *Journal of Electroanalytical Chemistry*, 436(1-2), 49-52.
- Smith, H. M. (2002). High performance pigments. *Germany*, 127-308.
- Uhler, A. D., & Helz, G. R. (1984). Precipitation of PbS from solutions containing EDTA. *Journal of crystal growth*, 66(2), 401-411.



**4TH INTERNATIONAL LATIN AMERICAN  
CONGRESS ON NATURAL AND APPLIED SCIENCES**

**EXPERIMENTAL INVESTIGATION OF THE EFFECT OF DIFFERENT  
DIAMETER CYLINDER USED IN HYDRO-PNEUMATIC SUSPENSION SYSTEM  
ON THE STRUCTURE**

**HİDRO-PNÖMATİK SÜSPANSİYON SİSTEMİNDE KULLANILAN FARKLI  
ÇAPLARDAKİ SİLİNDİRİN YAPI ÜZERİNDEKİ ETKİSİNİN DENEYSEL  
İNCELENMESİ**

**Kahraman KÜÇÜK**

Türk Traktör ve Ziraat Makineleri A.Ş., Ankara, Turkey.

ORCID NO: 0000-0001-8420-6003

**Prof. Dr. Fatih Mehmet BOTSALI**

Konya Technical University, Department of Mechanical Engineering, Konya, Türkiye.

ORCID ID: 0000-0001-5062-7221

**ABSTRACT**

The subject of this study is the hydro-pneumatic suspension (HPS) system, which has been widely encountered in recent years, especially in high-tonnage construction equipment. In the paper, the features and capabilities of the hydro-pneumatic suspension test unit that we manufacture are explained. This unit represents one fourth of a vehicle or a construction machine, based on the quarter vehicle model, which is especially encountered in comfort analyzes in vehicle dynamics. For the test unit, experiments were carried out for three different cylinders with different piston diameters, and a parametric infrastructure was created for the selection of the most suitable suspension system elements to be used in the systems according to the relevant parameters. The road data to be used as the disruptive input of the system were collected from the work machine and given to the system as displacement, and the outputs were examined. In this way, it is ensured that the correct disruptive inputs that will directly affect the structure are applied. According to the results obtained, the vertical movements of the structure were examined and the most sensitive valve and cylinder selection was made.

**Keywords:** Hydro-pneumatic suspension, Quarter Car, Design, Testing, Modeling.

## **ÖZET**

Bu çalışmanın konusu, özellikle yüksek tonajlı iş makinalarında son yıllarda yaygın olarak karşımıza çıkan hidro-pnömatik süspansiyon (HPS) sistemidir. Bildiride imalatını gerçekleştirdiğimiz hidro-pnömatik süspansiyon test ünitesinin özellikleri ve kabiliyetleri anlatılmıştır. Bu ünite taşıt dinamiğinde konfor analizlerinde özellikle karşımıza çıkan çeyrek taşıt modeli temel alınarak bir aracın ya da iş makinasının dörtte birini temsil etmektedir. Test ünitesi için farklı piston çaplarına sahip üç farklı silindir için deneyler yapılmış olup ilgili parametrelere göre sistemlerde kullanılması en uygun süspansiyon sistem elemanlarının seçimine yönelik ve parametrik bir altyapı oluşturulmuştur. Sistemin bozucu girdisi olarak kullanılacak yol verileri iş makinası üzerinden toplanarak sisteme deplasman olarak verilerek çıktılar incelenmiştir. Bu sayede doğrudan yapı üzerine etki edecek doğru bozucu girdilerin uygulanması sağlanmıştır. Elde edilen sonuçlara göre yapının düşeydeki hareketleri incelenerek en hassas valf ve silindir seçimi yapılmıştır.

**Anahtar Kelimeler:** Hidro-pnömatik süspansiyon, Çeyrek Taşıt, Tasarım, Test, Modelleme.

**ANALYSIS OF TOOL WEAR AND SURFACE ROUGHNESS VALUES IN THE  
MACHINING OF STAINLESS STEEL MATERIALS**

**PASLANMAZ ÇELİK MALZEMELERİN İŞLENMESİNDE TAKIM AŞINMASI VE  
YÜZEY PÜRÜZLÜLÜĞÜ DEĞERLERİNİN ANALİZİ**

**Fikret SÖNMEZ**

Dr. Öğr. Üyesi, Manisa Celal Bayar Üniversitesi

ORCID NO: 0000-0003-1718-892X

**ÖZET**

Talaşlı imalat yüksek boyutsal hassasiyete sahip parçaların üretilmesi için kullanılan temel yöntemlerden biridir. Bu yöntemde, kesici takım iş parçası üzerinden talaş kaldırırken sürekli olarak aşınmaktadır. Kesici takımlar açısından aşınma kontrol edilmesi gereken en önemli konulardan biridir. Kesici takımın mümkün olan en ekonomik şekilde kullanılırken üretkenliğin korunması üretim sürecinin sağlıklı olması açısından bir gerekliliktir. Bu nedenle takım ömrünün izlenmesi gerek endüstriyel gerek bilimsel en önemli araştırma konularından biridir. Bu çalışmada işlenmesi zor malzeme sınıfında yer alan paslanmaz çelik malzemeler üzerinde işlenebilirlik deneyleri gerçekleştirilmiştir. Deneylerde 150 m/dk sabit kesme hızı, 0,1 mm ilerleme hızı ve 0,8 mm kesme derinliği kullanılmış, takım ömrü ve yüzey pürüzlülüğü değişimi analiz edilmiştir. Deneylerde, 31. dakikanın sonunda takım ömrünün tamamlandığı anlaşılmıştır. Ayrıca takım yüzeyinde belirgin çentik aşınması ve talaş yapışması da gözlenmiştir. Bunların yanında yüzey pürüzlülüğünün takım aşınmasına bağlı olarak kötüleştiği tespit edilmiştir. Ayrıca birçok pasoda talaş sarma tespit edildiğinden yüzey kötüleşmesi de görülmüştür. Bununla birlikte kesici takımın aşınmasına bağlı olarak kimi pasolarda talaş sarma görülmediğinden yüzey kalitesi diğer pasolara kıyasla daha iyi sonuçlanmıştır.

**Anahtar Kelimeler:** Talaşlı imalat, Paslanmaz çelik, Takım ömrü, Yüzey pürüzlülüğü

**EXTENDED ABSTRACT**

Machining is one of the essential methods used to produce parts with high dimensional accuracy. With this method, the cutting tool continually wears while removing chips from the workpiece. The main cause of tool wear is the friction between the cutting tool and the workpiece and the various wear mechanisms that occur due to this friction. The main cause of tool wear is the friction between the cutting tool and the workpiece and the various wear mechanisms that occur due to this friction. Wear in cutting tools is affected by many factors, such as workpiece material, cutting tool material, and cutting conditions. In terms of cutting tools, wear is one of the most vital matters to be controlled. Maintaining productivity while

using the cutting tool in the most economical way possible is a necessity for a stable production process. For this reason, monitoring tool life is one of the most crucial research topics, both industrially and scientifically. In this study, machinability tests were carried out on stainless steel materials, which are difficult-to-cut materials. In the experiments, the change in tool life and surface roughness was analyzed using a constant cutting speed of 150 m/min, a feed rate of 0.1 mm, and a depth of cut of 0.8 mm. Tool wear measurements were performed using a toolmaker's microscope. After each pass, the cutting tool was examined, and the amount of wear was determined. Surface roughness measurements were taken from the workpiece surface five times at the end of each pass. Tool wear analyses were concluded with the flank wear value reaching the limit value of 300  $\mu\text{m}$ . In the experiments, it was understood that the tool life was completed at the end of the 31st minute due to flank wear. Significant notch wear and built-up-edge formation were also observed on the tool surface. The crater wear expected to be observed was not detected. It can be claimed that the reason for this is the cooling of the cutting tool and workpiece at the end of each pass due to measuring and the crater wear not developing sufficiently due to cooling. Besides, it was determined that the surface roughness deteriorated due to tool wear. In addition, surface deterioration was also observed because of chip wrapping in many passes. However, wear on the cutting tool caused no chip wrapping in some passes, and the surface quality was better than others. In addition, it was determined that the surface roughness of the workpiece slightly improved before the end of the tool's life.

**Keywords:** Machining, Stainless steel, Tool life, Surface roughness

## **GİRİŞ**

Talaşlı imalat gerek yüksek boyutsal doğruluk sunması gerekse istenen iş parçası geometrilerinin elde edilebilmesi nedeniyle önde gelen imalat yöntemlerinden biridir. Ayrıca talaşlı imalat ile çok düşük yüzey pürüzlülük değerlerine ulaşmak mümkündür. Bu nedenle imalat yöntemleri arasında öne çıkan bu yöntemin kullanım alanı sürekli olarak artmaktadır [1]. Talaşlı imalat ile birçok farklı malzeme türü kullanılarak farklı makine parçalarının imalatı mümkündür. Bununla birlikte bazı malzemeler sahip oldukları niteliklerden dolayı talaşlı imalata nispeten uygun değildir. Talaşlı imalat esnasında kesici takım ile iş parçası sürekli temas halindedir ve bu temas alanında yüksek sıcaklıklar meydana gelir. Paslanmaz çelikler düşük ısı iletkenlikleri nedeniyle kesme esnasında oluşan ısının kesici takımdan uzaklaşmasına yardım edemezler. Bu nedenle ısı takım ucunda sürekli olarak birikir ve erken takım aşınması gerçekleşir. Bunun sonucunda takım ekonomik değerini hızlıca kaybederken işlenen parçanın yüzey pürüzlülük değerleri ise sürekli bozulur [2-3]. Genel olarak çelik içerisinde %12'den fazla Cr bulunması durumunda paslanmaz çelik elde edilmektedir. Paslanmaz çelik malzemeler temel olarak dört sınıfta incelenebilir. 1. Ferritik 2. Martenzitik 3. Östenitik ve 4. Dupleks (Ferritik-Östenitik). Bu sınıflar arasında işlenebilirlik açısından en zorlu malzeme Dupleks (Ferritik-Östenitik) paslanmaz çeliklerdir. Bu durumun belirli sebepleri vardır. Bunların başında düşük ısı iletkenlik ve deformasyon sertleşmesi gelmektedir [2].

Rashid ve diğerleri yapmış oldukları çalışmada [4] takım aşınması ve işlenen malzemelerin yüzey pürüzlülüğü üzerine araştırmalar yapmışlardır. Bu araştırmalarda AISI 4340 malzeme üzerinde tornalama işlemi gerçekleştirilmiş ve düşük ilerleme değerlerinde kesici takım uç aşınmasının arttığını tespit etmişlerdir. Santhanakumar ve diğerleri maraging çeliğinin tornalaması ile ilgili yapmış oldukları çalışmada [5] optimum işleme şartlarının gerek takım aşınması gerekse yüzey pürüzlülüğü değerlerini ciddi şekilde iyileştirebileceğini

ortaya koymuştur. Böylelikle Ra değerini 0,8 µm seviyesinden 0,4 µm seviyesine ve serbest yüzey aşınma değerini 0,0445 mm değerinden 0,0234 mm değerine düşürmüşlerdir. Araújo ve diğerleri [6] çalışmalarında yüzey pürüzlülüğü ve takım aşınmasının etkilerini incelemişlerdir. Bu incelemelerde kesme sırasında ortaya çıkan ısının oldukça önemli olduğunu ve soğutma sıvısı kullanarak bu ısının düşürülmesinin önemini vurgulamışlardır. Böylelikle gerek yüzey pürüzlülüğü gerekse takım aşınmasının ciddi şekilde düşürdüğünü ileri sürmüşlerdir. Demir ve Adıyaman [7] takım yavaşma açısının takım aşınması üzerindeki etkilerini incelemiştir. Ayrıca işlenen malzemelerin yüzey pürüzlülüğü değerlerini de irdelemişlerdir. Araştırmacılar kesme şartlarının optimizasyonunun uygun olmaması durumunda kesici takımların ciddi şekilde aşındığını ortaya koymuşlardır. Bununla birlikte yüzey pürüzlülüğü değerlerinin de takım aşınmasına bağlı olarak bozulduğunu vurgulamışlardır. Chen ve diğerleri [8] paslanmaz çelik malzemelerin farklı kesme hızı, ilerleme değeri ve kesme derinliği parametreleri altında işlenebilirliklerini incelemiştir. Yapılan incelemelerde takım aşınması ve yüzey pürüzlülüğü değerleri analiz edilmiştir. Zamana bağlı olarak 6., 12. ve 18. dakikalarda yapılan analizlerde takımın önce hızlıca aşınma gösterdiği sonrasında aşınmanın sabit bir hızla ilerlediği ve 18. dakikada ciddi takım aşınmasının gözlemlendiğini vurgulamıştır. Bu aşınmaya bağlı olarak yüzey pürüzlülüğü değerlerinin 1,4 µm değerinden 19,4 µm değerine kadar kötüleştiğini tespit etmişlerdir. Fox-Rabinovich ve diğerleri [9] takma uçlu (insert) kesici takımlar ile yaptıkları tornalama deneylerinde CVD ve PVD kaplamalarının etkilerini araştırmışlardır. Özellikle yığıma kenar oluşumu temelli olarak yaptıkları takım ömrü çalışmalarında kaplamanın takım ömrü üzerinde belirgin etkisi olduğunu ileri sürmüşlerdir. Bu araştırmada kimi kesme şartlarında 8 kat daha az yığıma kenar oluşumu meydana geldiğini tespit etmişlerdir. Ayrıca yan yüzey aşınmasında ise CVD kaplamalarda çok daha az aşınma gözlemlenmiştir. Parsi ve diğerleri [10] çalışmalarında süper-dubleks paslanmaz çeliklerin işlenebilirliğini incelemiştir. Farklı kesme hızları ile yapılan deneylerde kaplamasız, AlTiN ve AlCrN kaplamaları takımlarda takım aşınma miktarının değişimi ve yüzey pürüzlülüğünde oluşan değişimi araştırmışlardır. Sonuç olarak kaplamasız takımların gerek yüzey pürüzlülüğü gerekse takım ömrü açısından daha başarısız sonuçlar ürettiği anlaşılmıştır. Bununla birlikte kaplamalı takımların ise birbirine yakın sonuçlar elde ettiği gözlenmiştir.

Bu çalışmada talaşlı imalat açısından zorlayıcı niteliklere sahip olan AISI 4462 (X2CrNiMoN2253) dubleks paslanmaz çelik malzeme üzerinde takım aşınması analizi yapılmıştır. Ayrıca işlenen parçanın yüzey pürüzlülüğündeki değişimin takım aşınmasına bağlı olarak nasıl değiştiği araştırılmıştır.

## 2. Materyal ve Metot

### 2.1. Materyal

Bu çalışmada işlenmesi zor malzeme sınıfında yer alan AISI 4462 (X2CrNiMoN2253) dubleks paslanmaz çelik malzemeler üzerinde takım ömrü ve yüzey pürüzlülüğü analizleri gerçekleştirilmiştir. AISI 4462 dubleks paslanmaz çeliğe ait ASTM E1086 standartlarına göre kimyasal kompozisyon Tablo 1.'de mekanik özellikler ise Tablo 2.'de sunulmuştur.

**Tablo 1.** AISI 4462 dubleks paslanmaz çeliğe ait kimyasal kompozisyon (%)

Element	C	Si	Mn	P	S	Cr	Mo	Ni	N
Ağırlıkça %	0,015	0,50	1,40	0,029	0,004	22,69	3,11	4,84	0,1690

**4TH INTERNATIONAL LATIN AMERICAN  
CONGRESS ON NATURAL AND APPLIED SCIENCES**

**Tablo 2.** AISI 4462 dubleks paslanmaz çeliğe ait mekanik özellikler

Mekanik özellik	Akma dayanımı (MPa)	Çekme dayanımı (MPa)	Uzama (%)	Sertlik (HBW)
Değer	488	692	47	218

Kesme deneyleri Korloy marka PTGNR2020K16 kater ve TNMG160404-HA (Grade PC9030) kesici uç (insert) ile gerçekleştirilmiştir. Deneyler Hasan Ferdi Turgutlu Teknoloji Fakültesinde Makine Mühendisliği bölümünde bulunan Goodway GLS-1500M CNC torna tezgahı ile gerçekleştirilmiştir. Yüzey pürüzlülüğü ölçümü için Mahr M300 terminali ve Mahr Marsurf RD18 ölçüm cihazı kullanılmıştır. CNC Torna tezgahı üzerinde iş parçasını sökmeden yüzey pürüzlülüğü ölçümü yapılabilmesi amacıyla CNC Torna tezgahının parça yakalayıcı kısmına bir fikstür yerleştirilmiştir. Ölçümler bluetooth destekli Mahr Marsurf RD18 ölçüm cihazı ile yapıp, sonuçlar Mahr M300 terminalinden alınmıştır. Yüzey pürüzlülüğü ölçümleri ISO 4288 standarttı temel alınarak gerçekleştirilmiştir. Takım aşınmasının ölçümü için Mahr MM200 takımçı mikroskobu kullanılmıştır. Bu mikroskoba M-Shot MD30 kamera ile aküple edilerek ölçüm fotoğraflarının dijital ortama nakledilmesi sağlanmıştır (Şekil 1.).



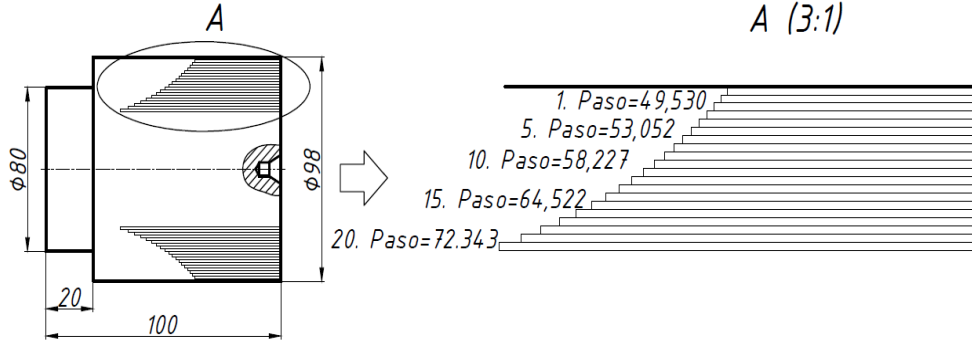
Şekil 1. Takım aşınması ölçüm sisteminin hazırlanması

AISI 4462 (X2CrNiMoN2253) paslanmaz çelik malzemeler üzerinde gerçekleştirilen takım aşınması deneyleri ISO 3685'e göre belirlenmiştir. ISO 3685 torna tezgâhı gibi tezgahlarda kullanılan tek noktalı kesici takımların aşınma değerlerinin tespitinde kullanılan temel standarttır. Deneylerde 0,8 mm talaş derinliği ve kesici takım üreticisi tarafından önerilen 150 m/dk kesme hızı kullanılmıştır. Deneyler kesme uzunluğu, kesici takım ömrü açısından 1 dakikalık kesme süresine denk gelecek şekilde gerçekleştirilmiştir. Bu nedenle deneylerde belirlenen kesme hızı için farklı kesme uzunlukları oluşmaktadır. Kesme uzunluğunun tespiti için Eşitlik 1'de görülen formül kullanılmıştır.

$$l = \frac{T_x f x 1000 x V}{\pi x d} \quad (\text{Eşitlik 1})$$

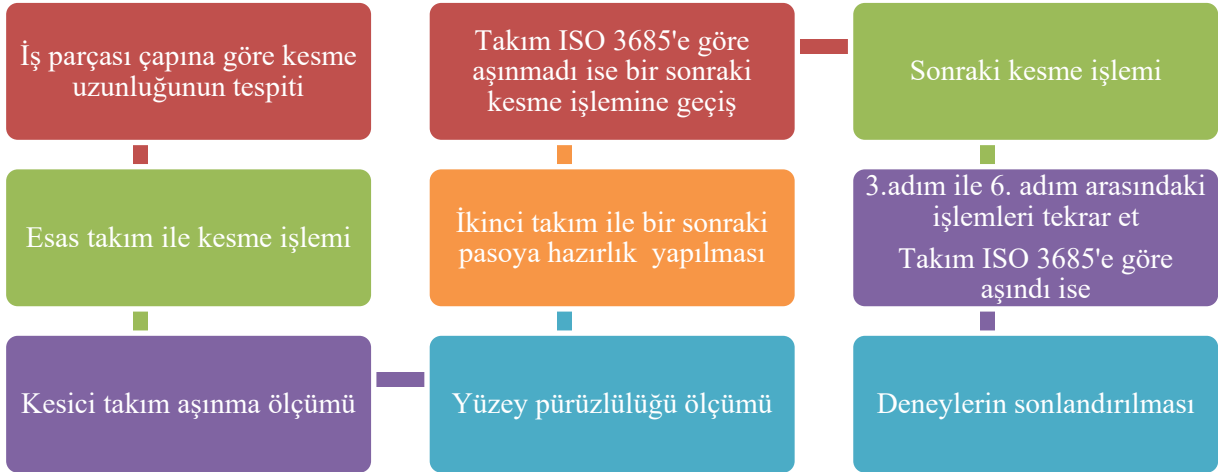
Eşitlik 1'e göre 1 dakikalık kesme ömrüne karşılık gelen kesme uzunluğu doğrudan iş parçası çapına bağlıdır. İş parçaları Ø100 mm ölçüsünde temin edilmiştir. Ancak malzeme yüzeyinde istenmeyen düzensizlikler olabileceği düşünülerek iş parçası üzerinden 2 mm talaş kaldırılarak malzeme çapı Ø98 mm'ye düşürülmüştür. Eşitlik 1'te görülen hesaplama her çap değeri için ayrı ayrı hesaplanmış ve hesaplanan kesme uzunluğuna göre kesme işlemi yapılmıştır. Çap değeri düştükçe kesme uzunluğunun arttığı görülmektedir. Şekil 2'de bu durum görselleştirilmiştir.





Şekil 2. İşlenen çap değerine bağlı olarak kesme uzunluğunun değişimi

Şekil 2.'de görülen bu durum teknik olarak birbirini takip eden pasolar arasındaki farkın ikinci bir takım ile temizlenmesi gerekliliğini ortaya koymaktadır. Bu sebeple her işlenen paso sonrası ikinci bir takım ile birbirini takip eden pasolar arasındaki fark temizlenmiştir. Şekil 3.'te sırasıyla yapılan bütün işlemler görülmektedir.

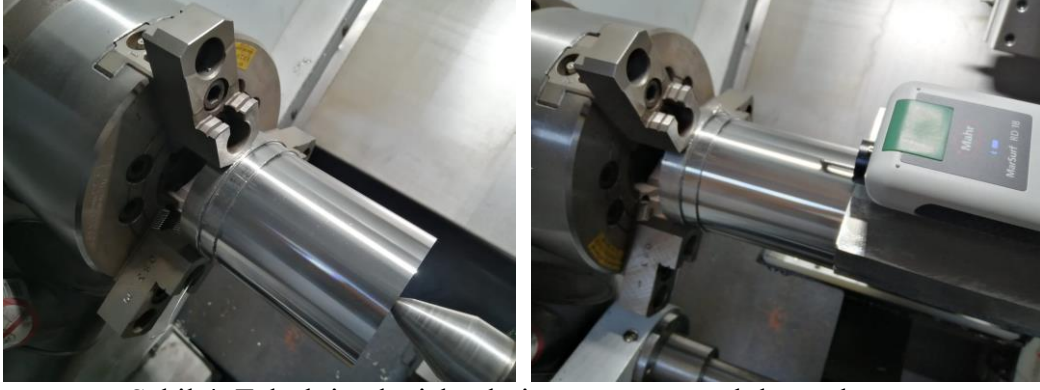


Şekil 3. Deney işlem sırası

Kesici takımını aşınmış kabul edilebilmesi için ISO 3685'e göre temel olarak üç kriterleri sürülebilir.

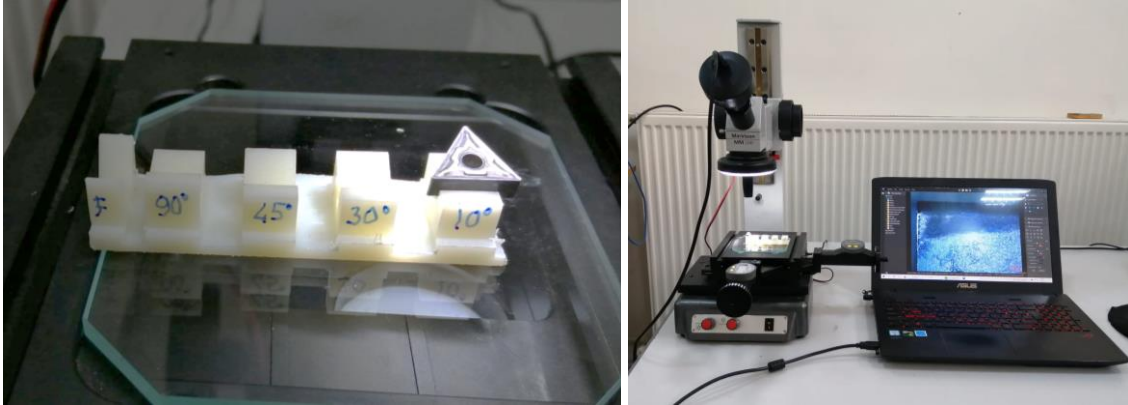
- Yan yüzey aşınması düzenli ise  $VB_B = 0,3$  mm olduğunda takım aşınmış kabul edilmektedir.
- Yan yüzey aşınmasının düzenli olmaması durumunda ise  $VB_{max} = 0,6$  mm olduğunda takım aşınmış kabul edilmektedir.
- Krater aşınması olması durumunda  $KT = 0,06 + 0,3f$  değerinden büyük bir aşınma takım ömrünün tamamladığını göstermektedir.

ISO 3685'te belirtilen aşınma durumlarına bağlı olarak Şekil 3.'te görülen işlemler her bir paso için ayrı ayrı gerçekleştirilmiştir. Her paso sonrası yapılan takım aşınması ölçümleri sonunda ISO 3685'te belirtilen şartlardan birinin oluştuğu gözlenmesi durumunda deneyler durdurulmuş ve takım ömrünün tamamlandığı kabul edilmiştir. Gerçekleştirilen talaşlı imalat ve yüzey pürüzlülük ölçümleri Şekil 4.'de görülmektedir.



Şekil 4. Talaşlı imalat işlemleri ve yüzey pürüzlülüğü ölçümü

Kesici takım aşınmasının incelenmesi amacıyla kesici takımın üzerine koyulabileceği ve farklı açılarda görüntü alınabilecek bir fikstür tasarlanmıştır (Şekil 5.). Takımcı mikroskobu tablasına yerleştirilen bu fikstür kullanılarak toplam altı adet görüntü alınması mümkündür. Bunlarda beş adedi  $10^\circ$ ,  $30^\circ$ ,  $45^\circ$ ,  $90^\circ$  ve F (Yan yüzey aşınması-Flank wear) kısımlarıdır. Fikstür üzerinde  $90^\circ$  ölçüm bölümü hem kesici uç üst yüzeyinin incelenmesi amacıyla hem de kesici takımı dik yerleştirerek burun aşınması kontrolü için kullanılmıştır. Böylelikle her paso sonunda toplam altı adet görüntü analiz edilmiştir. Kesici takım aşınma ölçümleri ise Şekil 5’te görülmektedir.

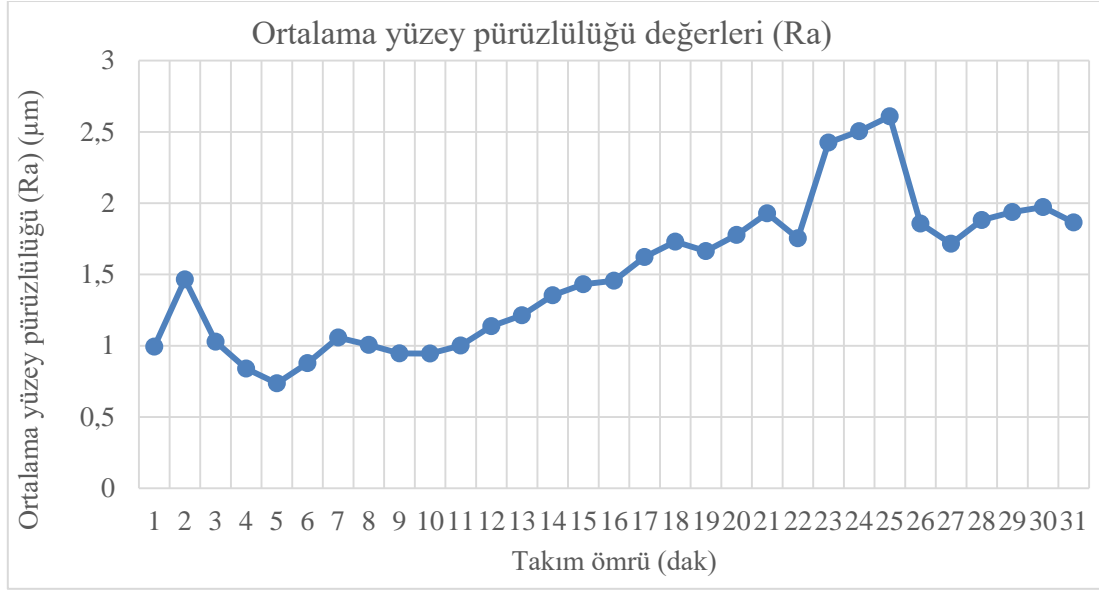


Şekil 5. Takım aşınmasının kontrolü için kullanılan fikstür ve ölçüm sistemi

### 3. Sonuçlar

#### 3.1. Yüzey Pürüzlülüğü Ölçüm Sonuçları

Talaşlı imalat ile her bir dakikalık takım ömrü sonunda iş parçası tezgahtan sökülmeden yüzey pürüzlülüğü ölçümleri gerçekleştirilmiş ve ortalama yüzey pürüzlülüğü değerleri (Ra) tespit edilmiştir. Bu amaçla tezgâh üzerinde  $72^\circ$  ( $360^\circ/5=72^\circ$ ) derece ile tüm yüzeyden elde edilen beş adet yüzey pürüzlülüğü ölçümünün ortalaması alınarak Şekil 6. elde edilmiştir.

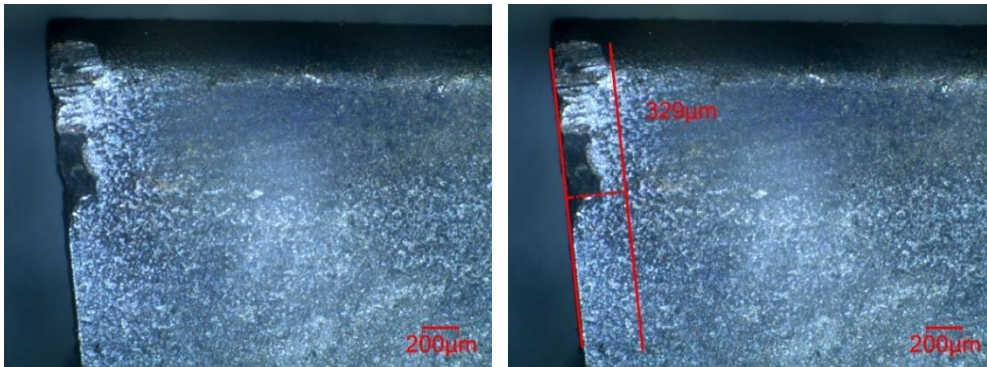


Şekil 6. Ortalama yüzey pürüzlülüğü değerleri

Ortalama yüzey pürüzlülüğü değerlerinin takım aşınmasına bağlı değişimi Şekil 6'da görülmektedir. Talaşlı imalat deneyleri ve yüzey pürüzlülüğü ölçümleri takım ömrü tamamlana kadar devam edilmiştir. Yapılan deneylerde takım ömrü 31. dakikada tamamlanmış bu nedenle 31 adet ortalama yüzey pürüzlülüğü verisi ölçülmüştür. Takım aşınması zamana bağlı olarak arttığından kesici uç zaman içerisinde kesme kenarlarını kaybetmektedir. Bunun sonucu olarak yüzey pürüzlülüğünde kötüleşme beklenebilir [11]. Yapılan deneyler de bu durum görülmekle birlikte zamana bağlı olarak kötüleşen yüzey pürüzlülüğü oldukça belirgindir. Kötüleşen yüzey pürüzlülüğü belirgin olmakla birlikte son 4-5 pasoda önceki pasolara kıyasla yüzey pürüzlülük değerlerinde iyileşme görülmüştür.

### 3.2. Takımcı Mikroskobu ile Takım Aşınması Ölçüm Sonuçları

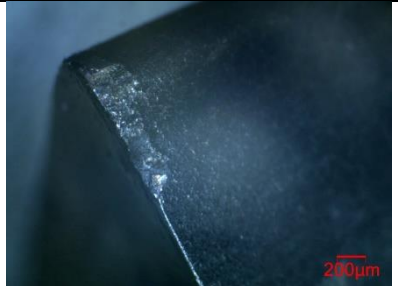




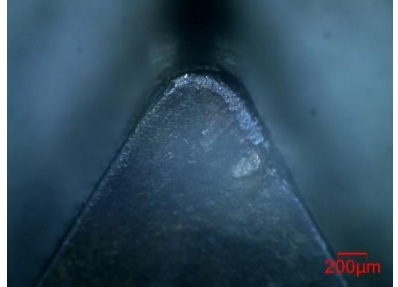
Takım aşınması ölçümlerinde farklı açılardan görüntüler elde edilmiş (Şekil 7) ve ölçümler yapılmıştır. Takımcı mikroskobu ile elde edilen görüntüler Tablo 4.'de sunulmuştur.



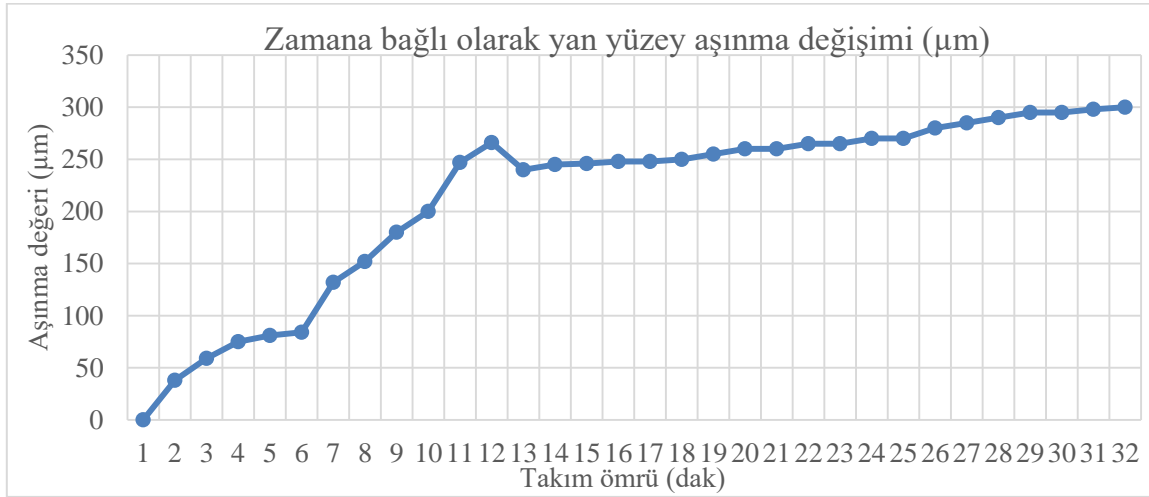
Şekil 7. Yan yüzey (serbest yüzey) aşınması

**4TH INTERNATIONAL LATIN AMERICAN  
CONGRESS ON NATURAL AND APPLIED SCIENCES**

**Tablo 4. Takım aşınmasının incelenmesi**

Açılı çekim	Burun aşınması	Üst Yüzey
		
45° açılı inceleme	30° açılı inceleme	10° açılı inceleme
		

Takımcı mikroskobu kullanılarak elde edilen 10°, 30°, 45°, 90° ve F (Yan yüzey aşınması-Flank wear) görüntüleri ile takım aşınması takip edilmiştir. Bununla birlikte 30° ve 45° açı ile alınan görüntülerin takım aşınmasının kontrolü için kullanılabilir durumda olmadığı görülmektedir. Takımcı mikroskobuna aküple edilen M-Shot MD30 kamera ile elde edilerek bilgisayar ortamına aktarılan görüntüler Digital image analysis yazılımı kullanılarak değerlendirilmiştir. Yazılım ile elde edilen aşınma değerlerinin zamana bağlı olarak değişimi Şekil 8.'te görülmektedir.



Şekil 8. Takımcı mikroskobu ile alınan görüntüler

Şekil 8'de görülen aşınma değerleri incelenmiştir. Takım aşınması önce hızlıca belli bir düzeye gelmiş ardından sabit bir eğimle artış göstermiş ve son olarak hızlıca artmıştır. Bu kesme şartlarında 31. dakika sonunda takım ömrünü tamamlamış ve ISO 3685'te belirtilen 0,3 mm (300 µm) takım aşınmasına ulaşılmıştır. Aşınma öncelikle hızla gerçekleşmiş, ardından sabit bir şekilde artmaya başlamış ve takım ömrü sonlarına doğru hızlıca artan



takım aşınması tespit edilmiştir. Literatür çalışmalarında da Letot ve arkadaşları [11] ve Derani ve arkadaşları [12] benzer şekilde takım ömrünün sonuna doğru hızlıca gelişen bir aşınma tespit etmişlerdir [11-12].

Takım aşınma türlerinin neredeyse tamamına bu çalışmada rastlanmıştır. Yan yüzey aşınması, burun aşınması ve yığıma kenar oluşumu belirgin şekilde tespit edilmiştir. Takım ömrü ISO 3685'e göre yan yüzey aşınmasına bağlı olarak tamamlanmıştır. Pekşen ve arkadaşları [12] yaptıkları çalışmada belirgin yan yüzey aşınması tespit etmişlerdir. Benzer şekilde Patil ve arkadaşları da belirgin yan yüzey aşınması tespit etmişlerdir [13]. Bununla birlikte literatürde sıklıkla görülen krater aşınması belirgin olarak görülememiştir. Pekşen [12] yan yüzey aşınmasının yanında belirgin krater aşınması tespit etmiştir. Benzer şekilde Wu ve arkadaşları da belirgin krater aşınması ile karşılaşmıştır [14]. Literatürde görülen krater aşınmasının mevcut deney şartlarında belirgin olmaması ısı girdisi ile ilişkilendirilebilir. Paslanmaz çelikler düşük ısı iletkenliğe sahiptir. Bu nedenle ısı, kesici takımında birikerek krater aşınmasını hızlandırır. Bununla birlikte mevcut deney şartlarında her paso sonrası kesici takımın sökülmesi ve gerekli ölçümlerin yapılması hem iş parçasının soğumasına hem de kesici takımın soğumasına neden olmuştur. Kuru işlem şartlarında beklenen krater aşınmasının meydana gelmemesi ölçümler esnasında takımın ve iş parçasının soğumasına bağlanabilir.

Kesici takımlar genel olarak aşındıkça kesme özellikleri kötüleşmekte ve talaşlı imalat daha kötü yüzey kalitelerine neden olmaktadır. Bu durumu Demir ve Zülküf vurgulamıştır [15]. Bu çalışmada da genel olarak takım aşınması arttıkça yüzey kalitesi kötüleşmiştir. Bununla birlikte ilginç bir şekilde son pasalarda yüzey kalitesinin önceki pasolara kıyasla iyileştiği görülmektedir. Bazı literatür kaynakları da benzer durumları rapor etmektedirler. Örneğin Derani ve arkadaşları [11] ile Akhavan ve arkadaşları [16] bu durumlar karşılaşmıştır. Takım ömrünün son kısımlarında işlenen parçasının yüzey kalitesinin iyileştiğini ortaya koymuşlardır [11,16].

## **6. Sonuç ve Öneriler**

Talaşlı imalat çok iyi yüzey kalitesi ve yüksek boyutsal doğruluk sunabilmesi nedeniyle diğer imalat yöntemlerinin önüne çıkan hassas ve kontrolü zor bir yöntemdir. Bu çalışmada işlenmesi zor malzeme sınıfında yer alan AISI 4462 (X2CrNiMoN2253) dubleks paslanmaz çelik malzeme üzerinde takım ömrü ve yüzey pürüzlülüğü deneyleri yapılmıştır. Bu kapsamda AISI 4462 malzemeler 150 m/dk kesme hızı ile talaşlı imalat işlemine tabi tutulmuştur. Kesici takımın bir dakikalık kesme süresine denk gelen kesme mesafesi kadar kullanılmasını takiben kesici takım üzerinde aşınma değerleri ve işlenen parçanın yüzey pürüzlülük değerleri ölçülmüştür. Bu işlemler sonucunda aşağıda belirtilen sonuçlar ortaya çıkmıştır.

Kesici takım üzerinde belirgin yan yüzey aşınması ana aşınma türü olarak öne çıkmıştır. Takım ömrü ISO 3685 standartına göre yan yüzey aşınmasının 0,3 mm (300 µm) değerine 31. dakika sonunda ulaşması ile tamamlanmıştır. Ayrıca çentik aşınması ve yığıma kenar oluşumu da gözlenmiştir. Bununla birlikte görülmesi beklenen krater aşınmasına rastlanmamıştır.

## 4TH INTERNATIONAL LATIN AMERICAN CONGRESS ON NATURAL AND APPLIED SCIENCES

Kesici takım aşınmasına bağlı olarak yüzey pürüzlülüğü değerlerinde kötüleşme tespit edilmiştir. Yapılan deneylerde daha kontrollü şartlar altında ve daha uzun süre ile aşınma gözlemlendiğinden yüzey pürüzlülüğü değerlerinde görülen bozulma daha belirgin olmuştur. Bununla birlikte takım ömrünü tamamlamak üzereyken iş parçalarının yüzey pürüzlülük değerlerinde bir miktar iyileşme tespit edilmiştir.

Talaşlı imalat birçok faktörden etkilenen karmaşık bir süreç olduğundan bundan sonraki çalışmalarda bu çalışmadan farklı olarak bazı konuların araştırılması mümkündür. Deneyler kuru işleme şartlarında gerçekleştirilmiştir. Aynı çalışmanın ıslak çalışma şartları yanında minimum miktarda yağlama ve vortex tüp ile soğutma gibi şartlar altında denenmesi ilgi çekici olabilir. Paslanmaz çelik malzemelerde meydana gelen deformasyon sertleşmesinin talaşlı imalat sonrası durumunun takip edilmesi önemli bir veri kaynağı olabilir. Ayrıca artan takım aşınmasına bağlı olarak kesme kuvvetlerinin ölçülmesi veya sonlu elemanlar metodu ile modellenmesi de yapılabilecek çalışmalar arasındadır.

### ACKNOWLEDGMENT

Bu çalışma Manisa Celal Bayar Üniversitesi Bilimsel Araştırma Projeleri Koordinasyon Birimi tarafından desteklenmiştir. Proje Numarası: 2022-036

### KAYNAKLAR

- [1] Groover, Mikell P. Fundamentals of Modern Manufacturing: Materials, Processes, and Systems, John Wiley & Sons, Amerika Birleşik Devletleri, 2020, 816 s.
- [2] ÇAKIR, M.C. Modern Talaşlı İmalatın Esasları (Modern Metal Cutting), Nobel Yayın-Dağıtım, Ankara, Türkiye, 2006, 308 s.
- [3] Ortner, H.M., Ettmayer P., and Kolaska H. The history of the technological progress of hardmetals. International Journal of Refractory Metals and Hard Materials 2014, 44: 148-159.
- [4] Rashid, W. B., Goel, S., Davim, J. P., & Joshi, S. N. Parametric design optimization of hard turning of AISI 4340 steel (69 HRC). The International Journal of Advanced Manufacturing Technology, 2016, 82(1), 451-462.
- [5] Santhanakumar, M., Adalarasan, R., Siddharth, S., & Velayudham, A. An investigation on surface finish and flank wear in hard machining of solution treated and aged 18% Ni maraging steel. Journal of the Brazilian Society of Mechanical Sciences and Engineering, 2017, 39(6), 2071-2084.
- [6] Araújo, R. P., Rolim, T. L., Oliveira, C. A., Moura, A. E., & Silva, J. C. A. Analysis of the surface roughness and cutting tool wear using a vapor compression assisted cooling system to cool the cutting fluid in turning operation. Journal of Manufacturing Processes, 2019, 44, 38-46.
- [7] Demir, Z., & Adiyaman, O. Investigation of influence of approach angle and chip slenderness ratio on vibration, chip formation and surface quality in turning of AISI 1050 steel. Journal of the Brazilian Society of Mechanical Sciences and Engineering, 2019, 41(10), 1-15.
- [8] Chen, J., Wang, Y., Zhang, Y., Yang, S., & Zhang, X. Investigation on tool wear mechanism during dry cutting 304 stainless steel. Manufacturing Technology, 2000, 20(1), 36-44.



**4TH INTERNATIONAL LATIN AMERICAN  
CONGRESS ON NATURAL AND APPLIED SCIENCES**

- [9] Fox-Rabinovich, G., Gershman, I. S., Yamamoto, K., Dosbaeva, J., & Veldhuis, S. Effect of the adaptive response on the wear behavior of pvd and cvd coated cutting tools during machining with built up edge formation. *Nanomaterials*, 2020, 10(12), 2489.
- [10] Parsi, P. K., Kotha, R. S., Routhu, T., Pandey, S., & Dwivedy, M. Machinability evaluation of coated carbide inserts in turning of super-duplex stainless steel. *SN Applied Sciences*, 2020, 2(11), 1-19.
- [11] Letot, C., Serra, R., Dossevi, M., & Dehombreux, P. Cutting tools reliability and residual life prediction from degradation indicators in turning process. *The International Journal of Advanced Manufacturing Technology*, 2016, 86(1), 495-506.
- [12] Derani, M. N., Ratnam, M. M., & Nasir, R. M. Improved measure of workpiece surface deterioration during turning using non-contact vision method. *Precision Engineering*, 2021, 68, 273-284.
- [13] Pekşen, H., & Kalyon, A. Optimization and measurement of flank wear and surface roughness via Taguchi based grey relational analysis. *Materials and Manufacturing Processes*, 2021, 36(16), 1865-1874.
- [14] Patil, P., & Karande, P. (2022). Experimental Investigations and Optimization of Machining Parameters in CNC Turning of SS304 Using Coolant at 0°C. *Journal of Manufacturing and Materials Processing*, 2022, 6(6), 128.
- [15] Wu, J., He, L., Wu, Y., Zhou, C., Zou, Z., Zhan, G., & Zhang, X. Enhancing Wear Resistance and Cutting Performance of a Long-Life Micro-Groove Tool in Turning AISI 201. *Coatings*, 2021, 11(12), 1515.
- [16] Demir, Z., & Adiyaman, O. Investigation of influence of approach angle and chip slenderness ratio on vibration, chip formation and surface quality in turning of AISI 1050 steel. *Journal of the Brazilian Society of Mechanical Sciences and Engineering*, 2019, 41(10), 1-15.
- [17] Niaki, F. A., & Mears, L. (2017). A comprehensive study on the effects of tool wear on surface roughness, dimensional integrity and residual stress in turning IN718 hard-to-machine alloy. *Journal of Manufacturing Processes*, 2017, 30, 268-280.

**MODELING IMPEDANCE CONTROL WITH LIMITED INTERACTION POWER  
FOR A 2R PLANAR ROBOT ARM**

**Abdullah ERDEMİR**

MPG Machinery Production Group Inc. Co., Konya, Türkiye.

ORCID ID:0000-0002-7267-3111

**Prof. Dr. Mete KALYONCU**

Konya Technical University, Department of Mechanical Engineering, Konya, Türkiye.

ORCID ID:0000-0002-2214-7631

**ABSTRACT**

Impedance control is a widely used concept in robotics to regulate the interaction between a robot and its environment in tasks such as pushing, polishing, cleaning, and grinding. The impedance controller regulates the dynamic relationship between the robot and the environment. The force applied by the robot to the environment depends on the position of the robot arm endpoint and the corresponding impedance. The interaction force directly affects the energy consumed by the robot, impacting the torques in the joints. This fact makes it imperative to control the interaction between the robot and the environment. However, in certain scenarios, the interaction power of the robot may be limited due to constraints such as actuator saturation, limited energy supply, or safety concerns. In these situations, it becomes crucial to model impedance control with limited interaction power to achieve effective and safe robot behavior. This study presents a detailed analysis of impedance control with limited interaction power, with a focus on developing an analytical model that accurately captures the dynamic behavior of the system while considering constraints on interaction power. The proposed model provides a framework for designing control strategies that can achieve desired behavior while satisfying the limitations. To optimize the impedance controller parameters, the Bees Algorithm is used. Following the optimization process, a model for interaction power limitation was developed, resulting in limited interaction power consumption for each joint. The effectiveness of the proposed model is demonstrated through simulations, showing successful control of the interaction between the robot and its environment with limited interaction power. Numerical and graphical results of the study are presented.

**Keywords:** Energy consumption, input trajectory functions, 2R planar robot arm, optimum impedance control, controller design, The Bees Algorithm.

## **1. INTRODUCTION**

The field of robotics has seen remarkable advancements in recent years, with robots being deployed across a wide range of industries, from manufacturing and healthcare to agriculture and space exploration. As robots are increasingly integrated into various applications, it becomes critical to ensure that they can interact safely and effectively with their environment. Impedance control has emerged as a popular concept in robotics to regulate this interaction, allowing robots to perform tasks such as pushing, polishing, cleaning, and grinding with high precision [1, 2]. To ensure the safety of both the robot and other entities in contact, it is essential to control the interaction between the robot and the environment.

In impedance control, the robot's endpoint is considered as a virtual spring-mass-damper system, and the controller regulates the dynamic relationship between the robot and the environment by adjusting the impedance of this system [3-6]. The impedance controller acts as an intermediary between the robot and its environment, enabling the robot to exert the desired force while also sensing the force feedback from the environment. This feedback is essential in ensuring that the robot can adapt to changes in the environment and maintain stable interactions [7]. The input trajectory function used in impedance control is also important in determining the interaction distance, interaction force, joint torques, and energy consumption of the robot [8].

However, in some scenarios, the interaction power of the robot may be limited due to various constraints, such as actuator saturation, limited energy supply, or safety concerns. In such cases, developing models for impedance control with limited interaction power becomes crucial to achieving safe and effective robot behavior.

Optimization algorithms are divided into two as global optimization algorithms and local search algorithms [9]. Global optimization algorithms such as Genetic Algorithm [10, 11], Particle Swarm Optimization [12] and The Bees Algorithm [13-16] focus on searching across the entire space. Local search algorithms such as Hooke-Jeeves [17] and Newton Raphson [18] focus on searching in local areas.

This study aims to provide a detailed analysis of impedance control under such conditions,

with a focus on developing an analytical model that accurately captures the dynamic behavior of the system while considering limitations on interaction power. The proposed model offers a framework for designing control strategies that can achieve the desired behavior while satisfying the constraints. Additionally, the study uses the Bees Algorithm to optimize the impedance controller parameters [7], and a model for interaction power limitation is developed, resulting in limited interaction power consumption for each joint.

The effectiveness of the proposed model is demonstrated through simulations, showing successful control of the interaction between the robot and its environment with limited interaction power. The numerical and graphical results of the study provide valuable insights for optimizing impedance controller parameters and developing control strategies for safe and effective robot behavior. Overall, this study contributes to the development of robotic systems that can operate safely and effectively in real-world environments with constrained interaction power.

## 2. MATHEMATICAL MODEL

The robotic arm examined in this study is a planar 2 degree-of-freedom (DOF) manipulator that consists of two revolute joints. The arm's physical structure comprises two links, each having a distinct mass denoted by  $m_1$  and  $m_2$  as shown in Figure 1.

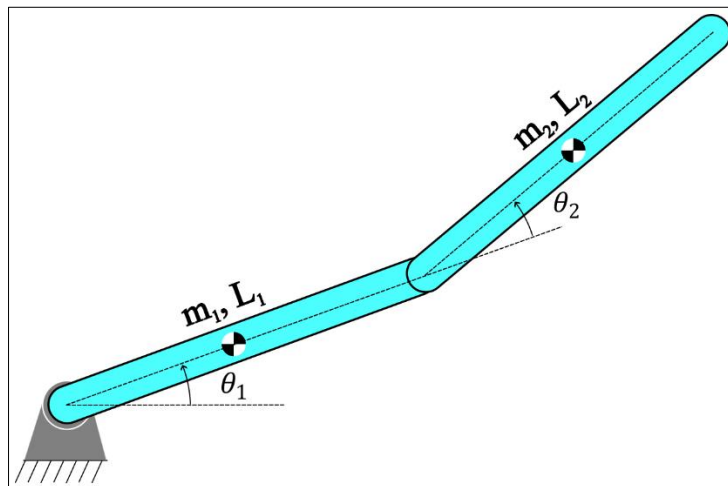


Figure 1. 2 dof robot arm

To establish the mathematical model for the planar 2R robot manipulator, it is necessary to determine the position of the center of mass relative to the joint angles. The relationship

**4TH INTERNATIONAL LATIN AMERICAN  
CONGRESS ON NATURAL AND APPLIED SCIENCES**

between the center of mass position of the robot's two linkages, characterized by their respective masses  $m_1$  and  $m_2$ , and the joint angles is described by Equation (1).

$$\begin{aligned}\bar{x}_1 &= \frac{L_1}{2} \cos \theta_1 \\ \bar{y}_1 &= \frac{L_1}{2} \sin \theta_1 \\ \bar{x}_2 &= L_1 \cos \theta_1 + \frac{L_2}{2} \cos(\theta_1 + \theta_2) \\ \bar{y}_2 &= L_1 \sin \theta_1 + \frac{L_2}{2} \sin(\theta_1 + \theta_2)\end{aligned}\tag{1}$$

To determine the mass moments of inertia of the linkages rotating around their respective centers of mass, the expression  $I = \frac{1}{12} mL^2$  is utilized. The kinetic energy of the system, denoted by  $T$ , is expressed by Equation (2), while the potential energy, represented by  $V$ , is described by Equation (3).

$$T = \frac{1}{2} m_1 (\dot{\bar{x}}_1^2 + \dot{\bar{y}}_1^2) + \frac{1}{2} I_1 \dot{\theta}_1^2 + \frac{1}{2} m_2 (\dot{\bar{x}}_2^2 + \dot{\bar{y}}_2^2) + \frac{1}{2} I_2 (\dot{\theta}_1 + \dot{\theta}_2)^2\tag{2}$$

$$V = m_1 g \bar{y}_1 + m_2 g \bar{y}_2\tag{3}$$

The equation of motion for the system can be derived by applying the Euler-Lagrangian equation. The Lagrangian expression for the system is given by Equation (4).

$$L = T - V\tag{4}$$

The equation for the joint torques can be derived from the Lagrangian expression, resulting in Equation (5).

$$\tau_i = \frac{d}{dt} \left( \frac{\partial L}{\partial \dot{\theta}_i} \right) - \frac{\partial L}{\partial \theta_i}\tag{5}$$

In order to obtain the values for the torques  $\tau_1$  and  $\tau_2$ , the equation of motion was calculated and is represented by Equation (6).

$$\begin{aligned} \tau_1 = & \left( \frac{1}{3} m_1 L_1^2 + m_2 \left( L_1^2 + \frac{1}{3} L_2^2 + L_1 L_2 \cos(\theta_2) \right) \right) \ddot{\theta}_1 + m_2 L_2 \left( L_1 \cos(\theta_2) + \frac{2}{3} L_2 \right) \ddot{\theta}_2 \\ & - m_2 L_1 L_2 \sin(\theta_2) \left( \dot{\theta}_1 \dot{\theta}_2 + \frac{1}{2} \dot{\theta}_2^2 \right) + \frac{1}{2} (m_1 + 2m_2) g L_1 \cos(\theta_1) \\ & + \frac{1}{2} m_2 g L_2 \cos(\theta_1 + \theta_2) \end{aligned} \quad (6)$$

$$\begin{aligned} \tau_2 = & \frac{1}{2} m_2 L_2 \left( L_1 \cos(\theta_2) + \frac{2}{3} L_2 \right) \ddot{\theta}_1 + \frac{1}{2} m_2 L_1 L_2 \sin(\theta_2) \dot{\theta}_1^2 + \frac{1}{3} m_2 L_2^2 \dot{\theta}_2^2 \\ & + \frac{1}{2} m_2 g L_2 \cos(\theta_1 + \theta_2) \end{aligned}$$

### 3. IMPLEMENTATION OF IMPEDANCE CONTROL

In order to implement impedance control, several steps must be taken, as depicted in Figure 2. The first step is to compute the forward kinematics and inverse dynamics equations for the desired interaction point of the robot, which is based on the joint angles. The next step is to determine the difference between the position derived from forward kinematics and the target position, which is then transformed into an interaction force by multiplying it with the spring constant and damping coefficients. This interaction force is then multiplied with the transpose of the Jacobian matrix, which results in torques at the joints. The torques computed from the inverse dynamics equations are then combined with these torques to derive the final torque that is sent to the robot, thereby providing control over the robot's interactions with its environment.

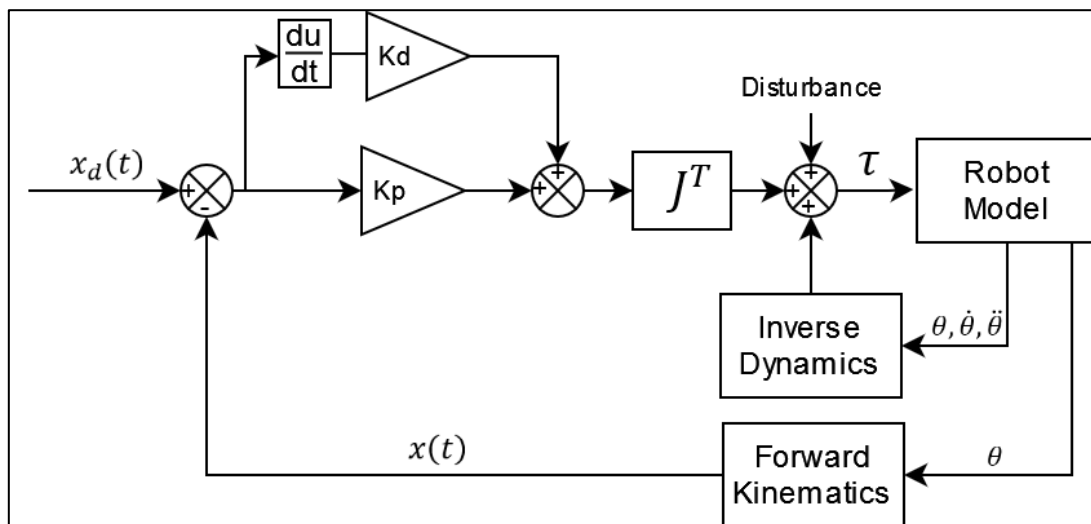


Figure 2. Impedance control schematics

The interaction force generated using PID control can be expressed mathematically in



Equation (7). The equation represents the feedback control loop used to minimize the error between the desired and actual position of the robot manipulator. The proportional gain ( $k$ ), integral gain ( $i$ ), and derivative gain ( $b$ ) are tuning parameters that determine the strength of the response to error, the rate at which the error is corrected, and the rate of change of the error, respectively. The error signal is obtained by subtracting the current position of the manipulator from the desired position, and the integral and derivative terms are obtained by integrating and differentiating the error signal over time, respectively. The resulting interaction force is then multiplied by the transpose of the Jacobian matrix to compute the joint torques required to achieve the desired interaction force.

$$F_{int} = k \begin{bmatrix} x_{2d} - x_2 \\ y_{2d} - y_2 \end{bmatrix} + b \begin{bmatrix} \dot{x}_{2d} - \dot{x}_2 \\ \dot{y}_{2d} - \dot{y}_2 \end{bmatrix} + i \int \begin{bmatrix} x_{2d} - x_2 \\ y_{2d} - y_2 \end{bmatrix} dt \quad (7)$$

The target position of the robot's endpoint, denoted by  $x_{2d}$  and  $y_{2d}$ , is compared to the actual position of the endpoint, represented by  $x_2$  and  $y_2$ . The equation that describes the position of the endpoint of the robot can be expressed mathematically as given in Equation (8).

$$\begin{aligned} x_2 &= L_1 \cos \theta_1 + L_2 \cos(\theta_1 + \theta_2) \\ y_2 &= L_1 \sin \theta_1 + L_2 \sin(\theta_1 + \theta_2) \end{aligned} \quad (8)$$

The conversion of the interaction force represented in Equation (7) into torques necessitates the multiplication by the Jacobian matrix of the endpoint of the robot. The Jacobian matrix of the system is mathematically expressed as Equation (9).

$$J = \begin{bmatrix} \frac{dx_2}{d\theta_1} & \frac{dx_2}{d\theta_2} \\ \frac{dy_2}{d\theta_1} & \frac{dy_2}{d\theta_2} \end{bmatrix} \quad (9)$$

$$J = \begin{bmatrix} -L_1 \sin(\theta_1) - L_2 \sin(\theta_1 + \theta_2) & -L_2 \sin(\theta_1 + \theta_2) \\ L_1 \cos(\theta_1) + L_2 \cos(\theta_1 + \theta_2) & L_2 \cos(\theta_1 + \theta_2) \end{bmatrix}$$

The impedance torques, obtained by multiplying the interaction forces with the transpose of the Jacobian matrix, are mathematically represented as Equation (10).

$$\tau_e = J^T F_{int}$$

$$\tau_e = \begin{bmatrix} -F_x(L_1 \sin(\theta_1) + L_2 \sin(\theta_1 + \theta_2)) + F_y(L_1 \cos(\theta_1) + L_2 \cos(\theta_1 + \theta_2)) \\ -F_x L_2 \sin(\theta_1 + \theta_2) + F_y L_2 \cos(\theta_1 + \theta_2) \end{bmatrix} \quad (10)$$

In Equation (10), the x component of the  $F_{int}$  force is represented as  $F_x$  while the y component is denoted as  $F_y$ . The final torques required for controlling the robot are obtained by summing the dynamic torques computed using Equation (6) with the impedance torques derived from Equation (10). The combined torques thus obtained are then transmitted to the robot, allowing the system to achieve the desired position and impedance control.

#### 4. NUMERICAL APPLICATION

$L_1 = L_2 = 1$  and  $m_1 = m_2 = 5 \text{ kg}$ . According to the scenario, the movement of the robot's endpoint is sequential, starting from point 1, then moving to points 2, 3, 4, and eventually returning to point 1, as shown in Figure 3. Throughout the movement of the endpoint, the interaction power is constrained to a maximum of 0.25 Watts.

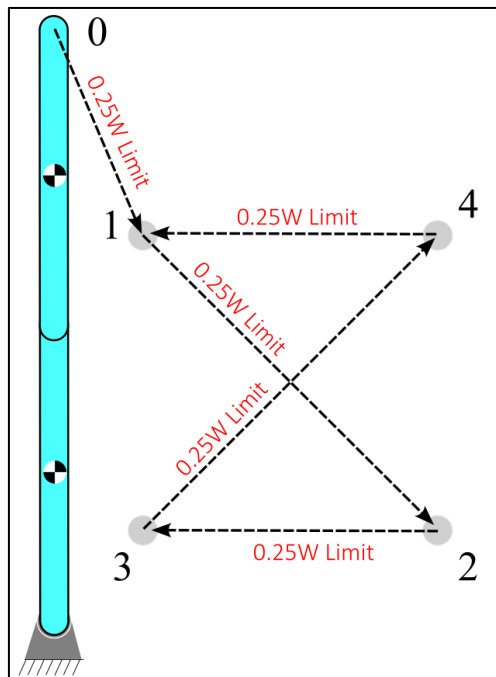


Figure 3. Numeric application view

Based on a previous study [8], the sinusoidal function was identified as the most energy-efficient function among seven different functions. Therefore, in this study, the sinusoidal function expressed in Equation (11) was chosen as the trajectory function for the robot's endpoint.

$$f_6 = \begin{cases} h_0 & , t < t_0 \\ h_0 + (h_1 - h_0) \frac{\sin(\pi(t_m - 0.5)) + 1}{2} & , t_0 \leq t \leq t_1 \\ h_1 & , t > t_1 \end{cases} \quad (11)$$

The desired motion trajectory is defined by the initial desired position,  $h_0$ , at time  $t_0$ , and the final desired position,  $h_1$ , at time  $t_1$ . To enable scaling of the time interval  $[t_0, t_1]$  to the range  $[0,1]$ , a scaled time parameter,  $t_m$ , is introduced, as shown in Equation (12).

$$t_m = \frac{t - t_0}{t_1 - t_0} \quad (12)$$

The objective function utilized to optimize the coefficients  $k$ ,  $b$ , and  $i$  in Equation (7) is defined as Equation (13).

$$f_{obj} = \int_{t_1}^{t_2} (x_{2d} - x_2)^2 + (y_{2d} - y_2)^2 \quad (13)$$

The objective function used for optimization of the coefficients  $k$ ,  $b$ , and  $i$  in Equation (7) is established by squaring the distance between the target and actual position, also known as the distance error. The objective of minimizing this function is to reduce the distance error and bring the actual position closer to the target position. The optimization results are shown in Table 1.

Table 1. The results of The Bees Algorithm

Initial Conditions			Initial Objective Function	The Bees Algorithm Result			Resulting Objective Function
<b>k</b>	<b>b</b>	<b>i</b>		<b>k</b>	<b>b</b>	<b>i</b>	
25	3	0	5.19	249.83	49.92	11.09	0.01

The requested interaction power of each joint is determined by the product of the angular velocity  $\omega_i$  and the impedance torque  $\tau_e$ , as expressed in Equation (14). However, in order to limit the interaction power,  $\tau_e$  is modified as  $\tau_{eL}$  and shown in Equation (15).

$$P_r = \omega \cdot \tau_e \quad (14)$$

$\tau_{eL}$  is modified in order to saturate the interaction power and is shown in (15).  $P_L$  is the power limit target and is selected in this example as 0.25 W,  $P_r$  is the requested power.

$$\tau_{eL} = \min\left(\frac{P_L}{|P_{r1}|}, \frac{P_L}{|P_{r2}|}, 1\right) \cdot \tau_e \quad (15)$$

### 3. RESULTS AND DISCUSSION

Figure 4 shows the comparison of endpoint locations with and without limited interaction power. Although the limited interaction power leads to an increase in the positioning error between the points, the positional error at the points is as low as that without any limitation.

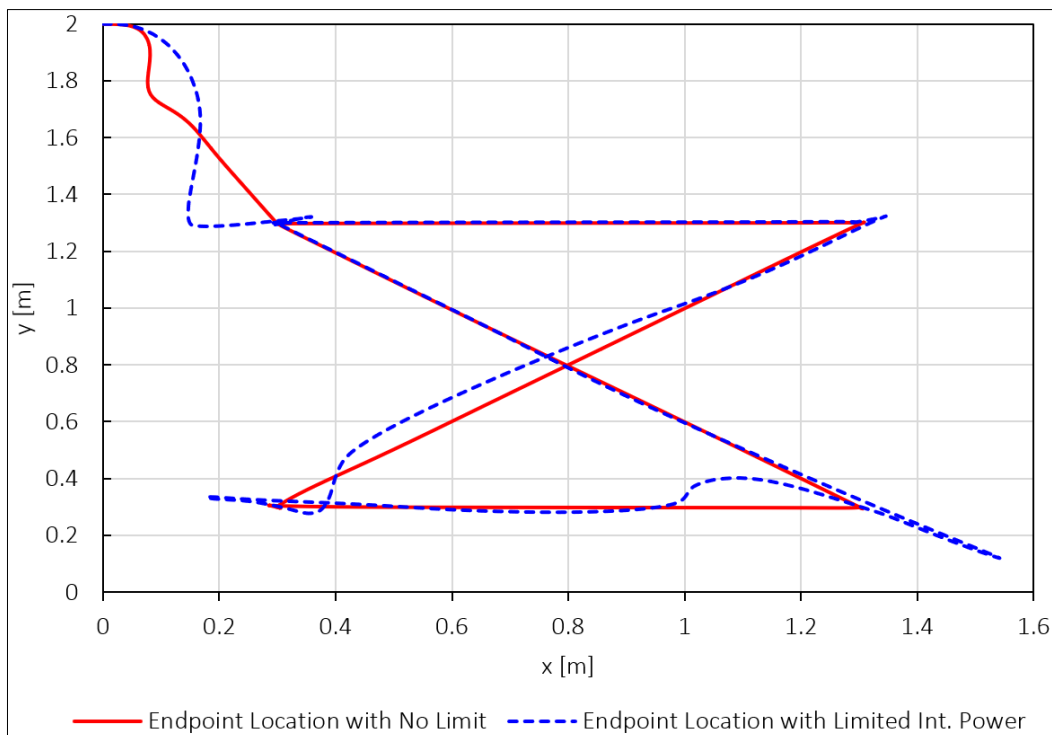


Figure 4. Endpoint location comparison between limited and unlimited interaction power

In the limited power interaction mode, the interaction torques may increase at some points due to the increasing positional error. This effect can be observed in Figure 5. However, in the starting position, the interaction torques are higher in the unlimited power interaction mode compared to the limited power interaction mode.

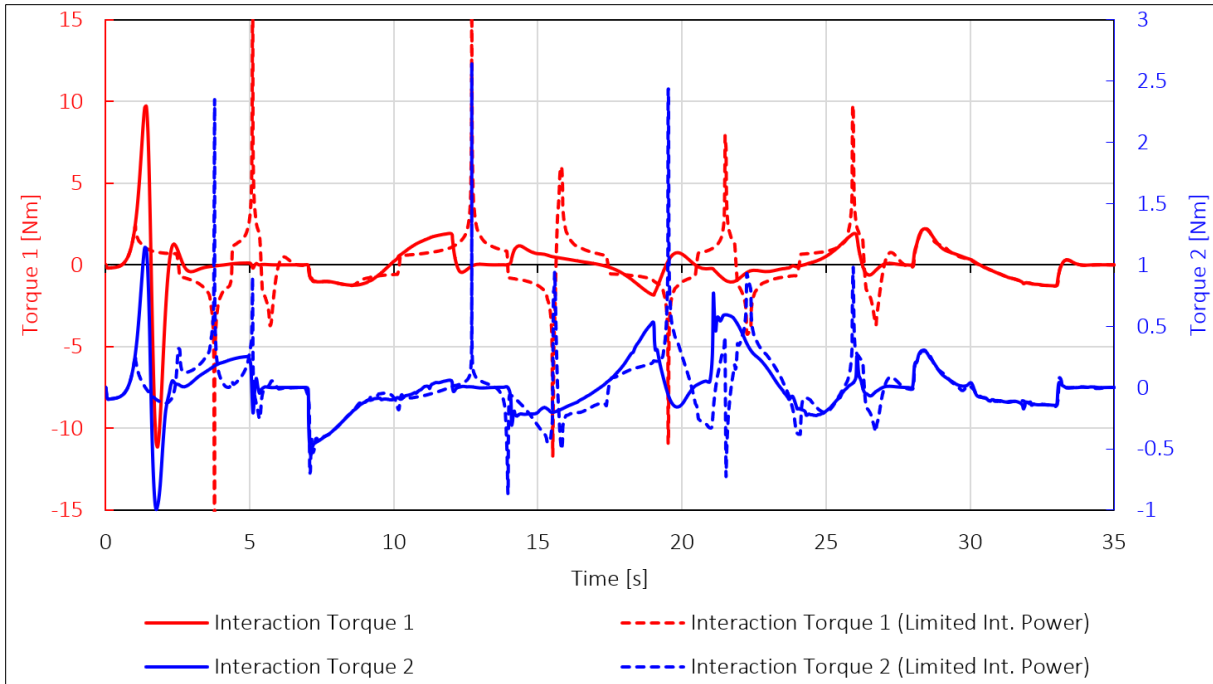


Figure 5. Interaction torque comparison between limited and unlimited interaction power

At the starting position, the angular velocities in the unlimited power interaction mode are higher than those in the limited interaction power mode. However, in later seconds, the angular velocities are higher in the limited interaction power mode. This trend can be observed from the angular velocity graph shown in Figure 6.

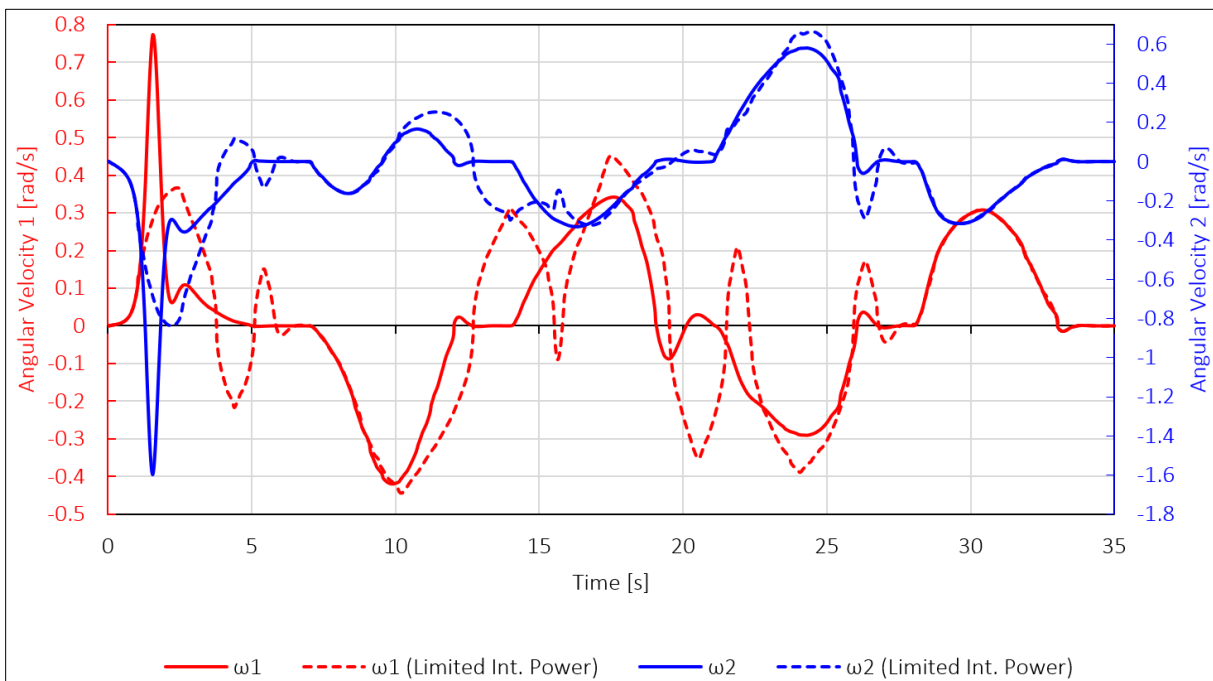


Figure 6. Joint angular velocity comparison between limited and unlimited interaction power

In the unlimited interaction power mode, the interaction powers are observed to reach up to 6 W. However, in the limited interaction power mode, the interaction power is limited to 0.25 W as expected, as shown in Figure 7.

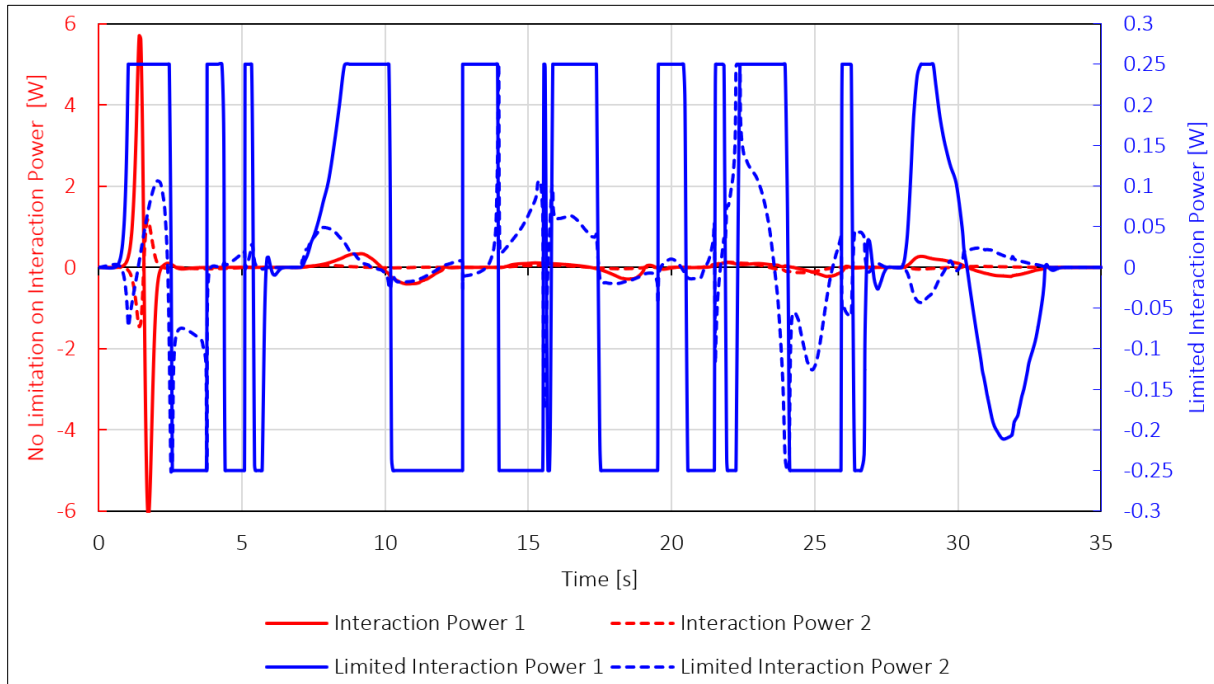


Figure 7. Interaction power comparison between limited and unlimited interaction power

Table 2 presents the interaction energy consumption in both the unlimited and limited interaction power modes. The results show that the interaction power consumption was increased by 1.62% in the limited interaction power mode compared to the unlimited interaction power mode.

Table 2. Interaction energy consumptions

<b>Interaction Power Mode</b>	<b>Interaction Energy Consumption of Joint 1 [J]</b>	<b>Interaction Energy Consumption of Joint 2 [J]</b>	<b>Total Interaction Energy [J]</b>	<b>Change Ratio</b>
Unlimited	5.97	1.46	7.43	0%
Limited	6.42	1.13	7.55	+1.62%

## CONCLUSIONS

In conclusion, this study presented a control method for a robotic arm to optimize the interaction power consumption while achieving precise positioning. The use of a sinusoidal trajectory function and an objective function based on minimizing the distance error led to a



significant reduction in the interaction power consumption. The limitation of interaction power to 0.25 W resulted in some increase in the positioning error between points, however the positional errors at the desired scenario points were still low. The study also showed that limiting the interaction power led to lower interaction torques and angular velocities compared to unlimited interaction power mode. However, the interaction power consumption was increased by 1.62% in the limited interaction power mode. Overall, the findings of this study demonstrate the effectiveness of the proposed control method in optimizing interaction power consumption while maintaining precision in robotic arm positioning.

As the results of this study have shown, the limited interaction power consumption method can be a promising approach for reducing power consumption peaks in industrial robots. Therefore, future studies could investigate the application of this method to larger and more complex industrial robots, as well as explore the potential benefits of combining this method with other power-saving techniques. Additionally, further research could also investigate the effect of different trajectory functions and optimization algorithms on the performance of the limited interaction power consumption method.

## REFERENCES

- [1] Bicchi, A., Kumar, V., 2000, *Robotic grasping and contact: A review*, Proc. Proceedings 2000 ICRA. Millennium conference. IEEE international conference on robotics and automation. Symposia proceedings (Cat. No. 00CH37065), IEEE, pp. 348-353.
- [2] Pliego-Jiménez, J., Arteaga-Pérez, M. A., 2015, *Adaptive position/force control for robot manipulators in contact with a rigid surface with uncertain parameters*, European Journal of Control, 22(pp. 1-12).
- [3] Hogan, N., 1984, *Impedance control: An approach to manipulation*, Proc. 1984 American control conference, IEEE, pp. 304-313.
- [4] Hogan, N., 1984, *Impedance control of industrial robots*, Robotics and computer-integrated manufacturing, 1(1), pp. 97-113.
- [5] Hogan, N., 1987, *Stable execution of contact tasks using impedance control*, Proc. Proceedings. 1987 IEEE International Conference on Robotics and Automation, IEEE, pp. 1047-1054.
- [6] Kumar, C., Mukherjee, A., Dasgupta, A., 1993, *A Study on Interaction Control through Passive Degrees of Freedom: Stability and Adaptation of Impedance Variation*, IETE Journal of Education, 34(1), pp. 1-20.
- [7] Erdemir, A., Kalyoncu, M., 2023, *Optimal Impedance Control of A 2R Planar Robot Manipulator*, Mas 17th International European Conference on Mathematics, Engineering, Natural & Medical Sciences, Cairo, Egypt, pp. 82-92.

**4TH INTERNATIONAL LATIN AMERICAN  
CONGRESS ON NATURAL AND APPLIED SCIENCES**

- [8] Erdemir, A., Kalyoncu, M., 2023, *Comparison of Energy Consumptions of Input Trajectory Functions in Impedance Controlled 2R Planar Robot Manipulator*, International Euroasia Congress on Scientific Researches and Recent Trends 10, Baku, Azerbaijan, pp. 312-325.
- [9] Erdemir, A., Kalyoncu, M., 2019, *Optimization of a Multi-Axle Steered Heavy Vehicle Steering Mechanism by using the Bees Algorithm and the Hooke-Jeeves Algorithms Simultaneously*, International Symposium on Automotive Science And Technology (ISASTECH 2019), Ankara/Turkey, pp. 613-622.
- [10] Lau, T. L., 1999, *Guided genetic algorithm*, pp. v, 166 leaves.
- [11] Ortmann, M., Weber, W., 2001, *Multi-criterion optimization of robot trajectories with evolutionary strategies*, Proc. Proceedings of the 2001 Genetic and Evolutionary Computation Conference. Late-Breaking Papers, Morgan Kaufmann San Francisco, CA, pp. 310-316.
- [12] Wang, D., Tan, D., Liu, L., 2018, *Particle swarm optimization algorithm: an overview*, Soft computing, 22(2), pp. 387-408.
- [13] Pham, D., Kalyoncu, M., 2009, *Optimisation of a fuzzy logic controller for a flexible single-link robot arm using the Bees Algorithm*, Proc. 2009 7th IEEE International Conference on Industrial Informatics, IEEE, pp. 475-480.
- [14] Erdemir, A., Kalyoncu, M., 2015, *Bir Ağır Vasıtanın Çok Akslı Direksiyon Mekanizmasının Arı Algoritması Kullanılarak Optimizasyonu*, Uluslararası Katılımlı 17. Makina Teorisi Sempozyumu UMTS 2015, pp. 421-426.
- [15] Pham, D. T., Koç, E., Kalyoncu, M., Tınkır, M., 2008, *Hierarchical PID controller design for a flexible link robot manipulator using the bees algorithm*, Proceedings of 6th International Symposium on Intelligent Manufacturing Systems, Sakarya, Turkey, pp. 757-765.
- [16] Erdemir, A., Alver, V., Kalyoncu, M., 2022, *Arı Algoritması Kullanılarak Önden Dümenlemeli Bir Aracın Dümenleme Mekanizmasının Optimizasyonu*, International Aegean Conferences on Innovation Technologies & Engineering 6, İzmir, Türkiye, pp. 50-59.
- [17] Hooke, R., Jeeves, T. A., 1961, *"Direct Search" Solution of Numerical and Statistical Problems*, Journal of the ACM (JACM), 8(2), pp. 212-229.
- [18] Ypma, T. J., 1995, *Historical development of the Newton–Raphson method*, SIAM review, 37(4), pp. 531-551.

**DEVELOPMENT OF FLAME RETARDANT PA6 AND PA66 COMPOSITES  
ACCORDING TO RAILWAYS EN 45545-2 STANDARD**

**Melih Yazıcı**

Bursa Technical University, Bursa, Turkey, 0000-0002-3745-2356  
Epsan, Research and Development Center, Bursa, Turkey

**ÖZET**

Yanma geciktiricili polimer karışımları, mühendislik plastikleri içerisinde önemini gittikçe arttıran malzeme sınıfıdır. Yangın gibi insan hayatı için tehlikeli afet durumlarında, plastiklerin yangın karşısındaki davranışı, verdiği reaksiyon, büyüme hızı çevresinde bulunan insanların hayatına doğrudan etki edebilen durumlardır. Plastiklerin maruz kalabilecekleri her türlü yangın tehlikesine karşı bariyer olma, durdurma veya yavaşlatma gibi karakteristikleri insan hayatının ve çevrenin korunmasına yardımcı olabilecek unsurlardır. Plastiklerin yanmaya karşı dirençleri, yanma geciktiricilik davranışları çeşitli normlarla belirlenebilmektedir. Bu normlar içerisinde en bilineni UL Sertifikasyon Kurumunca belirtilmiş UL-94 testidir. Bu test malzemenin yanma karakteristiğini V0, V1, V2 ve HB olarak sınıflamaktadır. Bu sınıflamalar içerisinde V0 karakteristiği alev geciktiriciliği en yüksek olan sınıfı, HB ise en düşük olan sınıfı belirtmektedir. Çeşitli kullanım alanlarında bu ve bunun gibi sınıflandırmalar doğru malzeme seçimi konusunda karar verilmesini sağlamaktadır. Toplu taşıma araçlarında ise UL'in dışında Avrupa Standartları Kurumu'na belirlenmiş olan EN 45545-2 standardı bulunmaktadır. Bu standart özellikle demiryolları gibi toplu taşıma vasıtalarında ne tür yanmazlık sınıfı ürünlerin hangi parçalarda kullanılabileceğini belirleyen standarttır. Bu kapsamda malzemelerin yangına karşı direnci, yanma reaksiyonu sırasında salınan duman toksikliği gibi yolcular için hayati önem taşıyan malzeme davranışlarını sınıflandırmaktadır. Bu çalışmada, EN 45545-2 standardınca belirlenmiş olan farklı kullanım alanlarında kullanılmak üzere geliştirilmiş olan polyamid 6 ve polyamid 66 kompozitleri geliştirilmiştir. Çalışmada her iki polimer türü de cam elyaf takviyeli (%25, %30, %35) demiryollarında kullanıma uygun olacak şekilde halojensiz alev geciktirici bileşenler ile üretilmiştir. Yanma geciktiricili katkıları farklı oranlarda (%16-22) formülasyona dahil edilmiştir. Kullanılan katkıları demiryollarında kullanıma uygun olacak şekilde düşük toksisiteye sahip bileşiklerden seçilmiştir. Geliştirilen kompozitlerin yanma davranışları dikey yanmazlık (UL-94), kızgın tel tutuşma sıcaklığı (IEC 60695-2-13), kızgın tel yanma indeksi (IEC 60695-2-12), yatay yanmazlık (FMVSS 302), Limit Oksijen indeksi (LOI), duman salınımı (EN ISO 5659-2), toksisite değeri (EN ISO 17094) EN 45545 standardında belirtilmiş olan konektör parçalarında kullanıma uygunluğunun belirlenebilmesi için test edilmiştir. EN 45545-2 standardınca belirlenen testler LAPI bağımsız laboratuvar şirketi tarafında test edilmiş ve tehlike seviyesi (HL) sınıflandırılmıştır. Aynı zamanda kompozitlerin fiziksel ve mekaniksel özellikleri; yoğunluk (ISO 1183), çekme-kopma özellikleri (ISO 527-2), çentiksiz ve çentiksiz darbe dayanım özellikleri (ISO 179/1eA, ISO 179/1eU), ısıl deformasyon sıcaklığı (HDT) testleriyle incelenmiştir. Çalışma kapsamında kompozitlerin nihai olarak kullanılacağı parça tasarımları üzerinde kızgın tel tutuşma sıcaklığı testi yapılarak malzemenin kullanımı uygunluğu doğrudan gözlemlenmiştir. Sonuç olarak, EPLAMID 6 GX0 30 ve EPLAMID 66 GX0 30 ürünleri için EN 45545 standardına uygun olarak HL3 seviyesinde R22, R23 ve R24 ihtiyaç setlerine uygunluk sertifikası alınmıştır.

## **ABSTRACT**

Flame retardant polymer composites are a class of materials that are becoming increasingly important in engineering plastics. In disasters that are dangerous for human life such as fire, the behavior of plastics against fire, their reaction, and growth rate are situations that can directly affect the lives of people around them. Characteristics of plastics such as being a barrier, stopping or slowing down all kinds of fire hazards they may be exposed to are elements that can help protect human life and the environment. The fire resistance and fire retardancy behavior of plastics can be determined by various norms. The most well-known among these norms is the UL-94 test specified by the UL Certification Authority. This test classifies the flammability characteristics of the material as V0, V1, V2 and HB. Among these classifications, the V0 characteristic indicates the class with the highest flame retardancy, and HB indicates the class with the lowest. This and similar classifications in various fields of use enable the decision on the suitable material selection. In public transportation vehicles, apart from UL, there is the EN 45545-2 standard, which is determined by the European Standards Institution. This standard is the standard that determines what kind of flammability class products can be used in which parts, especially in public transport vehicles such as railways. In this context, it classifies material behaviors that are vital for passengers, such as the resistance of materials to fire and the toxicity of smoke released during the combustion reaction. In this study, polyamide 6 and polyamide 66 composites, which were developed to be used in different usage areas determined by the EN 45545-2 standard, were developed. In the study, both polymer types were produced with glass fiber reinforced (25%, 30%, 35%) and halogen-free flame retardant components suitable for use in railways. The additives with fire retardant were included in the formulation at different rates (16-22%). The additives used were selected from compounds with low toxicity to be suitable for use in railways. Combustion behavior of the developed composites, vertical flammability (UL-94), glow wire ignition temperature (IEC 60695-2-13), glow wire flammability index (IEC 60695-2-12), horizontal flammability (FMVSS 302), Limit Oxygen Index (LOI), smoke emission (EN ISO 5659-2), and toxicity value (EN ISO 17094) has been tested to determine its suitability for use in connector parts specified in EN 45545 standard. The tests determined by the EN 45545-2 standard have been tested by an independent laboratory company LAPI and have been classified as hazard level (HL). At the same time, the physical and mechanical properties of composites; Density (ISO 1183), tensile properties (ISO 527-2), notched and unnotched impact strength properties (ISO 179/1eA, ISO 179/1eU), heat deflection temperature (HDT) tests were investigated. Within the scope of the study, the use of the material was directly observed by performing the glow wire ignition temperature test on the part designs where the composites will be used at the end. As a result, for EPLAMID 6 GX0 30 and EPLAMID 66 GX0 30 products, conformity certificates were obtained for the R22, R23 and R24 requirement sets at the HL3 level in accordance with the EN 45545 standard.

**4TH INTERNATIONAL LATIN AMERICAN  
CONGRESS ON NATURAL AND APPLIED SCIENCES**

**FINITE ELEMENT ANALYSIS BASED DEFORMATION ANALYSIS OF A  
SPECIFIC UNI-AXIAL COMPRESSION TEST SET-TO FOR DETERMINATION OF  
CIRCLIP LIMIT FORCE**

**C. BAKI**

**B. ÇETİN**

**B. SAFRAN**

**C. TANCI**

**C. BAKRAÇ**

Vector BTC Ltd. Şti, R&D Department, 06378, Yenimahalle, Ankara, Turkey  
FNSS Savunma Sistemleri A.Ş., R&D Center, 06830, Gölbaşı, Ankara, Turkey  
Tura Tasarım ve Mühendislik Ltd. Şti, Design Department, 06378, Yenimahalle, Ankara,  
Turkey

**ABSTRACT**

Unlike the conventional uni-axial tensile test, some extra fixtures and/or apparatus are needed in case of component-based verification studies. For instance, aiming to determine the max. bearing force of a circlip which runs for a transmission shaft, some complex mechanical set-up should be constructed. Furthermore, these extra apparatus create new challenges in terms of mechanical testing as like (i) due to high payloads some elastic deformations and/or deflections may take place during the test (ii) aforementioned deflections could bring up reasonable amount of controversial forces which eliminates the uni-axial loading scenario. Owing to those facts, necessary theoretical and/or numerical analysis should be performed beforehand to assure the precision of the mechanical test. This contribution was devoted to FEA based analysis of such a specific compression test set-up. Linear elastic analysis was conducted and the studied test design was modified until the desired max. deflection amount was satisfied.

**Keywords:** Uni-axial compression test, deflection, circlip

**THE IMPORTANCE OF PHYSICAL ACTIVITY IN IMPROVING PUBLIC  
HEALTH**

**Sadriddinova Dilobar Husniddin qizi**

Bukhara State University, Uzbekistan Bukhara

0000-0003-4880-1846

**ANNOTATION:**

This article discusses the importance and value of exercise in promoting public health.

We all know that regular exercise creates a healthy image for our children and youth.

Heals their will so that they grow up to be brave and courageous people, able to bravely overcome various trials and tribulations. creates a solid foundation. The most important thing is that we are children who are friends with sports. Does not join completely alien and harmful currents.

In order to form an immune system against the disease in Uzbekistan by involving all segments of the population in regular physical education and sports, on October 30, 2020, President Shavkat Mirziyoyev issued Decree No. PF-6099 “On the large-scale introduction of a healthy lifestyle”. lifestyle and the public Decree No. PQ-4063 of December 18, 2018 on Measures for the Further Development of Sports and Support for the Prevention of Noncommunicable Diseases, Healthy Lifestyles and Physical Activity of the Population. In accordance with the Decree "On measures to increase the level of industrial gymnastics" in state institutions and organizations during the working day. In order to ensure the implementation of the specified resolution and resolution, from January 1, 2021, the position of “Sports Promoter” was introduced in state bodies and organizations.

The role of a sports promoter is to organize the performance of industrial gymnastics by employees depending on working conditions. For this, special breaks are included in working hours.

The main task of a sports promoter is to organize a “Health Day”, which provides for the participation of employees in physical culture and mass events at least once a week, as well as regular sports competitions and other physical education events among employees. calculated.



## **4TH INTERNATIONAL LATIN AMERICAN CONGRESS ON NATURAL AND APPLIED SCIENCES**

Production gymnastic exercises are performed for 5-10 minutes during the day, taking into account the peculiarities of the work process.

Industrial gymnastics is a set of exercises performed during the working day in order to improve health and increase productivity.

Health is also a balanced unit of biological, mental, physical states and labor activity of the human body. Health is happiness for everyone.

A healthy lifestyle is a cultural, physical development of a person, a cocktail to increase productivity and creative activity. The main components of a healthy lifestyle are effective work, personal hygiene, giving up bad habits, proper nutrition at the appointed time, physical activity, regular physical activity.

Physical training is systematized with exercises and mass sports through exercise or physical activity at the level of physical maturity, the body's ability to withstand the adverse effects of the external environment and diseases, an adequate attitude to the requirements of life, life activity is understood.

In secondary schools, the health and performance of students is improved and strengthened on the basis of the correct organization of student behavior, which allows students of schools, academic lyceums and vocational colleges to study every day. reform requirements and covers rehabilitation work. The provision of these health-related activities, combined with classroom activities, ensures a high level of physical activity for students. This significantly reduces the fatigue of students and increases the effectiveness of educational activities.

The content of physical education, its means and age, gender, health status and physical training of participants Depending on the application, methods of application are developed separately.

Notably, it is widely used. Among them - health-improving physical training, applied means and methods.

Physical exercise has a positive effect on the human body and pay attention to the design features of the above was found. That is why physical education is so straightforward. It is worth dwelling on the concept. According to the great scientist Abu

## **4TH INTERNATIONAL LATIN AMERICAN CONGRESS ON NATURAL AND APPLIED SCIENCES**

Ali ibn Sino, the famous Russian scientist M.I. Sarkisov Sornzi and talented Uzbek scientist T.S. Usmonkhodzhaeva, the treatment of physically weak, sick children and adults with the help of physical exercises, as well as a variety of exercises used in the physical development of healthy people, therapeutic methods of their use are understood as physical culture.

From this comes content and meaning, which only heals. institutions, not just hospitals. but first of all, the whole family, kindergartens, schools, residences, recreation and amusement parks, sports facilities organization of mass physical culture and sports events reveals the essence of physical therapy.

In general, the physical and mental activity of people engaged in physical activity are exercises that ensure working capacity, various games, excursions, etc. promotes good health.

Only special exercises are used to ensure the physical fitness and skills of civil servants. without it, physical culture is used effectively and purposefully. This, in turn, promotes health and is an expression of developmental properties.

Healthy physical activity in different people different in their health, gender, physical condition by layers and categories training and interest in exercises and beliefs The corresponding designation was noted above. Healing physical full understanding and assimilation of the benefits and essence of education some artists who received home conditions in the morning, in the afternoon 2-3 times in the process of work, again after work in sports facilities or the habit of training in fitness centers It should be noted that Some people pass in the morning at least 5-6 km or more. running distances, some of which are different means (dumbbells, springs, elastic bands, etc.). Self 14 and some healthy football fans 1-2 times a day with peers and peers (in the workplace and in the community) to play football. A group of people from different areas (business) or neighborhood) to form teams (teams) and play football, argue like a competition (lay something in the middle) is possible) has become a habit in many places.

Remedial activities include:

## **4TH INTERNATIONAL LATIN AMERICAN CONGRESS ON NATURAL AND APPLIED SCIENCES**

1) Traditional sports events - sports festivals that are attended by all citizens, which has become a national tradition in the primary grades. New Year sports events; Sports event dedicated to Women's Day on March 8; Sports event dedicated to the holiday "Navruz" on March 21 and others.

2) Non-traditional activities, events held during the year on the basis of the annual calendar plan of the educational institution.

3) Daily wellness activities, morning physical training, exercise, pre-workout gymnastics, long break games, extended hours.

In a word, sports competitions of various forms, content, goals and objectives are aimed at increasing the physical fitness of the population, the formation of physical fitness, as well as increasing their interest in sports, the importance of physical culture and sports for human life. , sociocultural, educational - consciously leads to a conscious understanding of one's place in education and other areas.

Among the recreational activities held in an educational institution are physical education classes, classes in sports sections, sports competitions and sports holidays, as well as mass tourism.

**Keywords:** health improving gymnastics, sports promoter, health, healthy lifestyle, industrial gymnastics.

**ROLE OF APOPTOSIS AND PROLIFERATION OF VASCULAR WALL CELLS IN  
ATHEROGENESIS**

**Aigul Myrzabayeva**

**ABSTRACT**

**Target.** The aim of the work is to study the features of cell death and their proliferation in the wall of human arteries against the background of the development of immune inflammation during atherogenesis.

**Scientific novelty.** The scientific article discusses the stages of atherogenesis, indicates the mechanism of action of apoptosis and its role in atherogenesis. Also in the scientific article there is information and the study of promising agents in the pharmacotherapy of apoptosis in the treatment of human vascular atherosclerosis.

- It has been established that apoptosis of endothelial cells, caused by the action of macrophages, is a trigger mechanism for the rupture of atherosclerotic plaque.

-The aim of the work is to study the features of cell death and their proliferation in the wall of human arteries against the background of the development of immune inflammation during atherogenesis.

-The scientific article shows the results of a study by a group of scientists led by M.D. Rekhter, who studied atherosclerotic plaques, where, as a result, the topographic patterns of the distribution of proliferating cells depending on their type were determined.

-The role of apoptosis in the physiological processes of the body and the ways in which apoptosis is involved in the aging process are also described.

**Conclusions.** The work is of theoretical importance for deciphering the mechanisms of development of immune inflammation during atherogenesis. The results of this work can be used to study the pathogenesis of atherosclerosis and be taken into account in the development of new approaches to the treatment of this disease aimed at regulating the kinetics of arterial wall cells.

**Key words:** Apoptosis. Atherogenesis. Aging.

**THE RELATIONSHIP OF NEUTROPHIL-LYMPHOCYTE RATIO AND  
PROGNOSIS IN COVID-19 PATIENTS**

**Oya GÜVEN**

Assistant Professor, Kırklareli University Medical School

ORCID ID: 0000-0002-6389-4561

**Dilek VURAL KELEŞ**

Assistant Professor, Kırklareli University Health Sciences Faculty

ORCID ID: 0000-0002-4346-7474

**ABSTRACT**

The disease caused by COVID-19 has affected the whole world since its emergence. Although it was difficult to predict the damage and severity of the virus at the beginning, studies that examined the tests that could be prognostic markers came to the fore with the studies and clinical experience. The most important of these are the studies that predict the severity of the disease with the neutrophil-lymphocyte ratio in the hemogram analysis, which is a simple and rapid test. In this study, the relationship between the hemogram analysis of the patients at the time of admission to the hospital and the prognosis was tried to be examined.

In this study, between March 2020 and December 2021, the hemogram analysis of the patients who applied to the COVID outpatient clinic and whose results were compatible with PCR + or COVID pneumonia was examined. The patients, according to the outcome in the hospital, were divided into 2 groups, ex or discharged. The mean age of all patients included in the study was  $60 \pm 14.5$  years. The mean age ( $71.6 \pm 9.4$ ) and pneumonia severity rate were higher in the ex-group than in the other group. In addition, in the ex-group, the neutrophil count was higher, and the lymphocyte count was lower. It was observed that the poor prognosis of the elderly population with a high neutrophil-lymphocyte ratio and severe pneumonia.

According to the results of this study, the neutrophil-lymphocyte ratio of patients can be used as a prognostic indicator.

**Keywords:** COVID-19, Neutrophil-Lymphocyte Ratio, Prognosis, Pneumonia

## **INTRODUCTION**

The disease caused by the COVID-19 (SARS-CoV-2) virus, which started in China in December 2019 and caused a pandemic, caused an intense and rapid epidemic. The rapid deterioration of the patients and the inability to find a definitive treatment have created a challenging process for clinicians. Many studies have determined that the virus affects all organs, and treatment protocols have been constantly updated with the tests taken (Mir, 2021)). Therefore, studies in which tests that can be prognostic markers are interpreted from different perspectives have gained popularity.

In the course of the disease, blood tests vary for reasons such as viral load, existing chronic diseases, and the person's immune system response. Studies that can be easily interpreted by every clinician and that can predict the prognosis of the disease with inexpensive and rapid tests have come to the fore. Among these, the neutrophil-lymphocyte ratio (NLR) is thought to be an important clue in the course of the disease (Zhou Y, 2020).

In viral diseases, low neutrophil counts and high lymphocyte counts are expected. In the course of COVID-19 disease, since multisystem inflammation mainly develops, trauma develops due to overstimulation of immune system cells after cytokine storm, susceptibility to bacterial, fungal, and other viral infections occurs, and the balance in infection parameters seems to deteriorate (Chen N, 2020). As the disease progresses, T-cell proliferation increases, but the prognosis worsens due to the rise in cytotoxic cells. This is particularly evident in patients with severe pneumonia (Kang, 2020).

In this study, the hemogram analysis, a quick and inexpensive test routinely taken from all COVID-19 patients, tried to examine whether it is a prognostic marker with comorbidity and pneumonia severity.

## **MATERIAL AND METHODS**

This study was approved by the Kırklareli University Medical School Scientific Research Ethics Committee (20230008/4-21.02.23).

For this study, data from 178 random patients, among patients over 18 years of age, who applied to the emergency service COVID outpatient clinic between March 2020 and December 2021, and the COVID-19 virus was detected by PCR (Polymerase chain reaction) test, or an image compatible with COVID pneumonia was obtained in the thorax tomography examined. Demographic characteristics, comorbidities, neutrophil and lymphocyte counts, pneumonia severity, and prognosis were analysed for these patients.



## **4TH INTERNATIONAL LATIN AMERICAN CONGRESS ON NATURAL AND APPLIED SCIENCES**

The pneumonia severity score was categorised for each patient as mild (I), moderate (II), and severe (III), according to the radiological reports. Patients were divided into 2 groups, ex and survivors, and comparisons were made.

This study was designed as a single-centre retrospective. Patient data were obtained from the hospital archive, computer records, and patients' health system records. Mean, standard deviation, median lowest, highest, frequency and ratio values were used in the descriptive statistics of the data. Kolmogorov Smirnov test in the distribution of variables, independent sample T-Test, and Mann-Whitney U test in the analysis of independent quantitative data. The Chi-square test was used in the analysis of independent qualitative data. The ROC curve investigated the effect level and cut-off value, and the effect level was analysed by univariate and multivariate logistic regression. SPSS 28.0 program was used in the analysis.

### **RESULTS**

The mean age of all patients included in the study was  $60 \pm 14.5$  years. There were 70 female patients (39.3%) and 108 male patients (60.7%). All patients had upper respiratory tract infection symptoms and pneumonia findings of varying severity.

The mean age ( $71.6 \pm 9.4$ ) and pneumonia severity rate (III-86.1%) were higher in the ex-group than in the other group. In addition, in the ex-group, the neutrophil count was higher, and the lymphocyte count was lower. Therefore, this group's N/L ratio was higher (Table 1, Figure 1).

Among the patients in the Ex-group, the rate of those with comorbidity was higher. When the comorbidity in both groups was examined, those diagnosed with coronary artery disease were higher (Table 1).

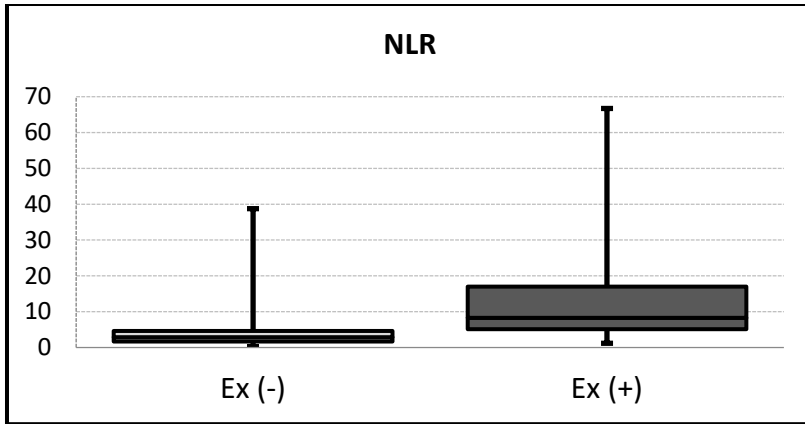
**4TH INTERNATIONAL LATIN AMERICAN  
CONGRESS ON NATURAL AND APPLIED SCIENCES**

**Table 1: Findings of patients' ex and survivor groups**

		Ex (-)		Ex (+)		p
		Mean.±SD n-%	Median	Mean.±SD n-%	Median	
Age		57.4 ± 14.2	58.0	71.6 ± 9.4	74.0	<b>0.000</b> <sup>m</sup>
Gender	Female	60	42.3%	10	27.8%	0.112 <sup>X<sup>2</sup></sup>
	Male	82	57.7%	26	72.2%	
NEU		5.2 ± 3.3	4.4	8.7 ± 4.9	8.5	<b>0.000</b> <sup>m</sup>
LYM		1.7 ± 0.9	1.5	1.0 ± 0.6	0.8	<b>0.000</b> <sup>m</sup>
NLR		4.5 ± 5.5	2.8	12.4 ± 12.1	8.3	<b>0.000</b> <sup>m</sup>
NLR	< 4.5	104	73.2%	6	16.7%	<b>0.000</b> <sup>X<sup>2</sup></sup>
	> 4.5	38	26.8%	30	83.3%	
Pneumonia Severity	I	39	27.5%	1	2.8%	<b>0.000</b> <sup>X<sup>2</sup></sup>
	II	59	41.5%	4	11.1%	
	III	44	31.0%	31	86.1%	
Comorbidity	(-)	70	49.3%	5	13.9%	<b>0.000</b> <sup>X<sup>2</sup></sup>
	(+)	72	50.7%	31	86.1%	
*						
CAD		60	42.3%	26	72.2%	<b>0.001</b> <sup>X<sup>2</sup></sup>
DM		34	23.9%	8	22.2%	0.828 <sup>X<sup>2</sup></sup>
HL		16	11.3%	2	5.6%	0.310 <sup>X<sup>2</sup></sup>
CKD		6	4.2%	5	13.9%	<b>0.031</b> <sup>X<sup>2</sup></sup>
COPD		6	4.2%	1	2.8%	1.000 <sup>X<sup>2</sup></sup>

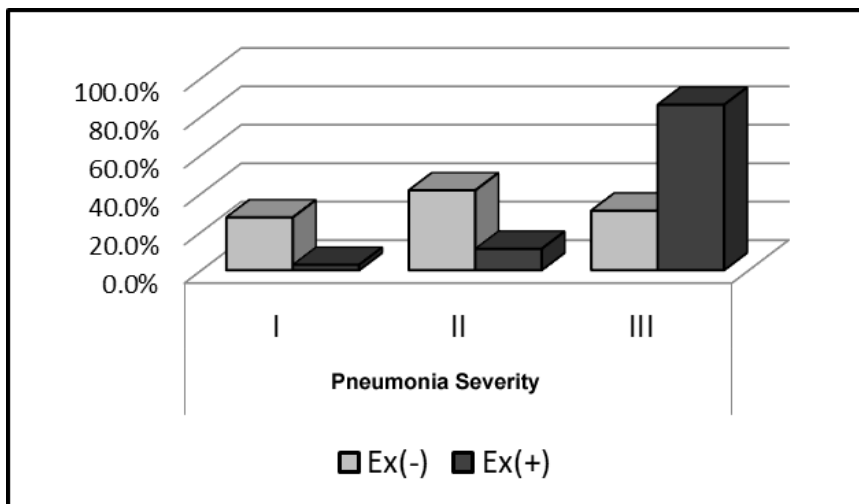
*NEU: Neutrophil number, LYM: Lymphocyte number, NLR: Neutrophil Lymphocyte Ratio, CAD: Coronary artery disease, DM: Diabetes Mellitus, HL: Hyperlipidaemia, CKD: Chronic Kidney Disease, COPD: Chronic Obstructive Pulmonary Disease*

\**Patients have more than one comorbidity.*



**Figure 1: Prognosis of patients according to neutrophil lymphocyte ratio**

It was observed that the prognosis worsened as the pneumonia severity of the patients increased (Figure 2).



**Figure 2: Prognosis of patients according to pneumonia severity**

In the univariate model, in separating the patients into the two groups, a significant ( $p < 0.05$ ) efficacy of age, neutrophil count, lymphocyte count, NLR, pneumonia severity, having CAD and CRF disease was observed. The multivariate model observed significant and independent ( $p < 0.05$ ) efficacy of age, NLR, and pneumonia severity (Table 2).

**4TH INTERNATIONAL LATIN AMERICAN  
CONGRESS ON NATURAL AND APPLIED SCIENCES**

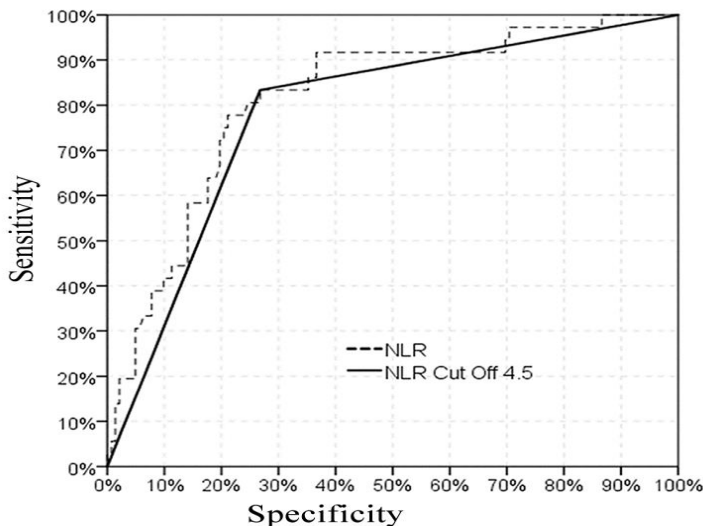
**Table 2: Results of patients' findings according to logistic regression analysis**

	Univariate Analysis			Multivariate Analysis		
	OR	%95 CI	p	OR	%95 CI	p
Age	1.110	1.064 - 1.158	<b>0.000</b>			
NEU	1.219	1.113 - 1.337	<b>0.000</b>			
LYM	0.238	0.116 - 0.488	<b>0.000</b>			
NLR	1.137	1.073 - 1.205	<b>0.000</b>	1.085	1.023 - 1.151	<b>0.007</b>
Pneumonia						
Severity	7.757	3.264 - 18.436	<b>0.000</b>	5.655	2.322 - 13.774	<b>0.000</b>
Comorbidity	6.028	2.217 - 16.389	<b>0.000</b>			
CAD	0.281	0.126 - 0.627	<b>0.002</b>			
CKD	0.274	0.078 - 0.954	<b>0.042</b>			

Logistic Regression (Forward LR)

*NEU: Neutrophil number, LYM: Lymphocyte number, NLR: Neutrophil Lymphocyte Ratio, CAD: Coronary artery disease, CKD: Chronic Kidney Disease*

A significant [Area under the curve 0.816 (0.740-0.892)] effectiveness of NLR value was observed in the discrimination of ex-groups and survivor groups, and the NLR cut-off value was determined to be 4.5 [Area under the curve 0.783 (0.700-0.866)] (Figure 3).



**Figure 3: ROC curve showing the NLR significant value**

## **DISCUSSION**

In this study, age, NLR and pneumonia severity were the most important predictors of prognosis.

Some studies have determined that the prognosis is poor, especially in patients over 65 with comorbidity (Albitar, 2020; Covid, 2020; Zhou F, 2020; Chen T, 2020). The most important factor causing this may be the weak immune system of the elderly population and currently damaged tissues, comorbidity, and vulnerability to trauma caused by the virus.

Endothelial damage develops during infection with the COVID-19 virus. As a result, overexpression of pro-inflammatory cells such as IL-1b, IL-6, and TNF alpha is observed (Landmesser, 2021). The severity of this damage increases with the developing cytokine storm. Overactivation of immune system cells, increase in oxidant substances, tissue hypoxia and thrombosis eventually, endothelium and vasculitis develop (Hasan, 2021). All these irregular systemic responses affect the prognosis.

Zeng et al., in their study, found that the prognosis was poor in the follow-up of patients with a high NLR rate at admission to the hospital (Zeng, 2021).

In the studies, it has been found that the virus binding to the ACE-2 receptor triggers the inflammatory pathway that causes damage. Thus, the prognosis worsens due to the increased tendency to thrombosis (Roncati, 2021). This may have been explained by the strong correlation between the severity of the damage in the lung tissue because of the tissues with the highest ACE-2 receptor and the seriousness of the prognosis in this study. In addition, the high number of patients with CAD in this study indicates that people with chronic vascular pathology are more susceptible to the virus than other chronic diseases.

The NLR value effectively predicts the prognosis of the disease. The results of this study show that the NLR level can be a guide for distinguishing severe/mild cases, the clinical worsening rapidly, and deciding which unit to follow (discharge, service, or intensive care unit).

## **REFERENCES**

Albitar, O., Ballouze, R., Ooi, J. P., & Ghadzi, S. M. S. (2020). Risk factors for mortality among COVID-19 patients. *Diabetes research and clinical practice*, 166, 108293.

Chen, N., Zhou, M., Dong, X., Qu, J., Gong, F., Han, Y., ... & Zhang, L. (2020). Epidemiological and clinical characteristics of 99 cases of 2019 novel coronavirus pneumonia in Wuhan, China: a descriptive study. *The lancet*, 395(10223), 507-513.

**4TH INTERNATIONAL LATIN AMERICAN  
CONGRESS ON NATURAL AND APPLIED SCIENCES**

Chen, T., Wu, D. I., Chen, H., Yan, W., Yang, D., Chen, G., ... & Ning, Q. (2020). Clinical characteristics of 113 deceased patients with coronavirus disease 2019: retrospective study. *bmj*, 368.

Covid, C. D. C., Team, R., Bialek, S., Boundy, E., Bowen, V., Chow, N., ... & Sauber-Schatz, E. (2020). Severe outcomes among patients with coronavirus disease 2019 (COVID-19)—United States, February 12–March 16, 2020. *Morbidity and mortality weekly report*, 69(12), 343.

Hasan, K. S., Peter, L., & Paul, M. R. (2021). COVID-19—a vascular disease. *Trends Cardiovasc Med*, 31(1), 1-5.

Kang, C. K., Han, G. C., Kim, M., Kim, G., Shin, H. M., Song, K. H., ... & Oh, M. D. (2020). Aberrant hyperactivation of cytotoxic T-cell as a potential determinant of COVID-19 severity. *International Journal of Infectious Diseases*, 97, 313-321.

Landmesser, U., Lehmann, I., & Eils, R. (2021). Hyperinflammation as underlying mechanism predisposing patients with cardiovascular diseases for severe COVID-19.

Mir, T., Almas, T., Kaur, J., Faisaluddin, M., Song, D., Ullah, W., Sattar, Y. (2021). Coronavirus disease 2019 (COVID-19): Multisystem review of pathophysiology. *Annals of Medicine and Surgery*, 69, 102745.

Roncati, L., Manenti, A., Manco, G., Farinetti, A., & Mattioli, A. (2021). The COVID-19 arterial thromboembolic complications: from inflammation to immunothrombosis through antiphospholipid autoantibodies. *Annals of Vascular Surgery*, 72, 216.

Zeng, Z. Y., Feng, S. D., Chen, G. P., & Wu, J. N. (2021). Predictive value of the neutrophil to lymphocyte ratio for disease deterioration and serious adverse outcomes in patients with COVID-19: a prospective cohort study. *BMC Infectious Diseases*, 21(1), 1-6.

Zhou, F., Yu, T., Du, R., Fan, G., Liu, Y., Liu, Z., ... & Cao, B. (2020). Clinical course and risk factors for mortality of adult inpatients with COVID-19 in Wuhan, China: a retrospective cohort study. *The lancet*, 395(10229), 1054-1062.

Zhou, Y., Yang, Z., Guo, Y., Geng, S., Gao, S., Ye, S., ... & Wang, Y. (2020). A new predictor of disease severity in patients with COVID-19 in Wuhan, China. *MedRxiv*, 2020-03.



**MATERNAL IMMUNITY TOLERANCE**

MATERNAL IMMUN TOLERANS

**Nursin AYDIN**

Ph.D., Dicle University

0000-0003-0265-3163

**ABSTRACT**

The immune system is a system that is specialized to distinguish between what is its own and what is not, and it is quite adept at doing this. If it detects non-self antigens, it alerts the necessary cells and intervenes as soon as possible. Although this system is necessary and vital, in an exceptional situation such as pregnancy, it could have caused life to end before it even started. Therefore, the semi-allogeneic embryo/fetus is managed by the maternal immune system throughout pregnancy and this situation is described as maternal immune tolerance. It is known that this system is realized with the contribution of many mechanisms, although it is not fully understood. However, this special tolerance system is not the mother's response to external factors, but only a system related to the placenta and trophoblast cells. Different views were put forward as to what kind of mechanism this particular system had at the beginning. However, for various reasons, all but one were refuted, and it was emphasized that only embryonic/fetal cells were hidden from the maternal immune system, that is, the existence of an immune barrier. Many mechanisms contribute to this hiding phenomenon, but the soluble human leukocyte antigen called HLA-G is very important as the best-understood factor. HLA-G is expressed by trophoblasts and functions by inhibiting the activation of cytotoxic T and Natural Killer (NK) cells. In addition, the embryo itself contributes to providing the appropriate environment through the substances it secretes. The progesterone hormone, which has an immunosuppressive effect, belongs to the mother and can be counted among the contributing factors. Apart from these, many mechanisms are effective. Clarification of this issue in all aspects may prevent miscarriage cases or discover new treatment methods, as well as provide a more successful result in organ transplantation processes.

**Keywords:** Embryo, Fetus, HLA-G, Maternal tolerance, Trophoblast

## **ÖZET**

İmmün sistem, kendine ait olan ile olmayana ayıt etmek için özelleşmiş ve bunu yapmada oldukça ustalaşmış bir sistemdir. Kendinden olmayan antijenleri tespit etmesi durumunda gerekli hücreleri alarma geçirerek en kısa zamanda müdahalede bulunur. Bu sistemin, aslında gerekli ve hayati olmasına karşın gebelik gibi istisnai bir durumda aynı şekilde işlemesi canlılığın başlamadan bitmesine sebep olabilir idi. Bu nedenle yarı-allojenik olan embriyo/fetus gebelik boyunca anne immün sistemi tarafından idare edilmekte ve bu durum maternal immün tolerans olarak nitelendirilmektedir. Bu sistemin, tam olarak anlaşılmamış olmakla birlikte pek çok mekanizmanın katkısıyla gerçekleştiği bilinmektedir. Fakat bu özel tolerans sistemi annenin dış etkenlere karşı verdiği tepkileri değil sadece plasentada ve trofoblast hücreleri ile ilişkili bir sistemdir. Aslında başlangıçta bu özel sistemin nasıl bir mekanizmaya sahip olduğuna dair farklı görüşler ileri sürüldü. Fakat çeşitli sebeplerle biri hariç hepsi çürütüldü ve bunun ancak embriyonik/fetal hücrelerin saklanmasıyla anne immün sisteminden saklandığı yani bir immün bariyerin varlığı üzerinde duruldu. Bu saklanma olayına pek çok mekanizma katkıda bulunmaktadır fakat HLA-G denen çözünebilir insan lökosit antijeni en iyi anlaşılabilmiş faktör olarak oldukça önemlidir. HLA-G, trofoblastlar tarafından eksprese edilir ve sitotoksik T ve Natural Killer (NK) hücrelerinin aktivasyonunu engelleyerek işlev gösterir. Ayrıca embriyonun kendisi de salgıladığı maddeler vasıtasıyla uygun ortamı sağlamaya katkıda bulunmaktadır. İmmünsüpresif etkiye sahip olan progesteron hormonu anneye ait olup katkıda bulunan faktörler arasında sayılabilir. Bunlar haricinde de pek çok mekanizma etkilidir. Bu konunun her yönüyle açıklığa kavuşması, düşük durumlarının engellenebilmesi veya yeni tedavi yollarının keşfedilmesini ayrıca organ nakil süreçlerinin daha başarılı sonuçlanmasını sağlayabilir.

**Anahtar Kelimeler:** Embriyo, Fetüs, HLA-G, Maternal tolerans, Trofoblast

## **Introduction**

The maternal immune tolerance system can be defined as the sum of the concessions made for the continuation of humanity. Although our immune system is a system that is programmed to make war against all elements that do not belong to us when it comes to the fetus, this situation works in reverse and the fetus is almost embraced by the mother. There are many reasons for this. However, four possible mechanisms for this have previously been suggested. The first is the theory that the fetus does not reach immunological maturity at a level that may pose a risk or activate maternal immunity (De Lemos, 2003; Izgi & Sur, 2009). However, this theory was disproved when it was revealed that fetal tissues can create immunological responses. A second theory was that the uterus was a particularly immune-tolerant site, but the existence of ectopic pregnancies disproved this theory as well (De Lemos, 2003; Izgi & Sur, 2009). The third theory was that the placenta is an anatomical barrier preventing cell trafficking. However, this was refuted by the detection of micro-chimerism phenomena, that is, cell transitions between mother and offspring. The last and still emphasized theory is that the placenta has a complex immune barrier. Ultimately, for a successful pregnancy to occur, that is, for the maternal immune system to accept a part that is not from itself, it must be prevented from perceiving the fetal tissue as foreign (Izgi & Sur, 2009). And this is made possible by the interoperability of many of the mechanisms that will be described.

### **1. Immune System**

Organism; It is always open to pathogens such as bacteria, viruses, fungi, and parasites. It is essential to have a fighting mechanism against these infectious and toxic factors, and in these cases, the immune system and its elements come into play. Lymphocytes, monocytes, macrophages, natural killer cells, antigen-presenting cells, and immunoglobulins are the components of the immune system. These cells eliminate pathogens by phagocytosis or by producing antibodies. When an antigen enters the body, macrophages first try to attack and phagocytize the antigen. If antigenic structures of the antigen remain in the cytoplasm of the macrophage during this phagocytosis, the macrophages present this to the lymphocytes and the process continues until the last piece is destroyed. In other words, every foreign substance that enters the body, even if it is the fetus in question, must be subjected to the same aggressive treatment, but for the continuation of humanity, the fetus is favored. (Özer, 2011).

## **2. Embryological development**

After the zygote is formed, it undergoes a series of successive divisions and is called the morula (McGeady et al., 2011). The cells in the inner part close to the vegetative pole of the morula gradually dissolve to form a cavity called the morula cavity. With the expansion and growth of this space, the blastosol is formed and after this process, it is called the blastula. The ectoderm cells surrounding the blastosol are in a single layer. The ectoderm here acts as solid nutrition and is therefore called the trophoblast (Izgi & Sur, 2009; McGeady et al., 2011). Trophoblasts are very important because they belong to the fetus, one of maternal tolerance's main elements.

### **2.1. Formation of sacs**

The blastocyst that has reached the uterus must be protected against external factors. For this reason, four sacs are formed to fulfill different tasks; amnion, vitellus, allantois, and chorion. These sacs are also collectively called extraembryonic sacs. While the amnion sac is only the sac that surrounds the embryo, the chorion sac is the largest sac that contains all the sacs and the two are shaped together. The Allantois sac also acts as an excretory organ and collects metabolic wastes. The first sac formed is the yolk sac, unlike poultry, it has nothing to do with nutrition in mammals, it only helps to carry nutrients until the allantois sac is formed (Izgi & Sur, 2009; Keskin, 2012; McGeady et al., 2011). Its main function is related to the formation of primitive blood cells, germ cells, and intestinal tract formation.

Chorion has functions such as respiration, nutrition, secretion, filtration, and synthesis and also takes part in the formation of the placenta (Hassa & Aşti, 1997). The ectoderm, which covers the outer surface of the chorion, fuses to the uterine mucosa during placentation and is called trophoblast since it also fulfills its nutritional function (Hassa & Aşti, 1997). During the implantation process, the chorion sends villi toward the uterine mucosa. The outer surface of these villi is also covered with trophoblasts. There are two types of trophoblasts; outer syncytiotrophoblast with intermingled cytoplasm and cytotrophoblast underlying it, which is seen as the main epithelium. The function of syncytiotrophoblasts is to facilitate the implantation process and are also responsible for bidirectional material transport (Hassa & Aşti, 1997; Izgi & Sur, 2009; McGeady et al., 2011). Cytotrophoblasts act as stem cells for syncytiotrophoblasts (Izgi & Sur, 2009). Apart from these, there are also extravillous trophoblasts. At the beginning of pregnancy, they invade the uterine mucosa to secrete HLA-G antigen, which contributes to maternal immune tolerance (Zhuang et al., 2021). They also

have the potential to form uterine blood vessels to supply enough blood for the fetus (Straszewski-Chavez et al., 2005).

## **2.2. Placenta**

It is a specialized structure formed by the fusion of chorion and uterine mucosa and to meet the needs of the fetus, which is still dependent on the mother. It provides the metabolic and hormonal relationship between the mother and the offspring and also has roles such as communication, gas exchange, nutrition, waste removal, and immunological protection (Keskin, 2012). It consists of two parts belonging to the mother and the baby; The epithelial layer, connective tissue and endothelial part of the uterus form the placenta maternal part, while the corion epithelium (trophoblast cell layer), mesenchyme, and endothelial layer form the placenta fetal part (McGeady et al., 2011). These two sections serve maternal tolerance by shaping the placental barrier (Keskin, 2012; McGeady et al., 2011).

## **3. Mechanisms Playing a Role in Maternal Tolerance**

In fact, maternal tolerance is a system that comes into play with the formation of implantation. Because during the implantation phase, inflammatory cytokines begin to be released from neutrophils and macrophages. There are also T and B lymphocytes, macrophages, and natural killer cells in the uterine mucosa (Izgi & Sur, 2009). All these conditions reveal that maternal tolerance is an indispensable condition. For this reason, the embryo itself (actually, trophoblast cells, which are in direct contact with the uterus, which means trophoblast cells and secrete immunosuppressants) acts like a warrior and tries to provide the necessary environment for itself. Some of the reasons that reveal this include successful implantations in embryo transplants and the formation of pregnancies outside the uterus.

The presence of non-classical human leukocyte antigens is the first in a series of mechanisms (Izgi & Sur, 2009; Straszewski-Chavez et al., 2005). And the organism uses the tissue compatibility antigens called MHC-I and II, which are included in this class, as markers in distinguishing between its own and foreign ones. Normally, MHC-I is found in all nucleated cells, but not particularly in syncytiotrophoblast and extravillous trophoblasts (Izgi & Sur, 2009; Straszewski-Chavez et al., 2005). Although MHC-II is found on antigen-presenting cells, it is not found in antigen-presenting cells in the placenta (Izgi & Sur, 2009; Straszewski-Chavez et al., 2005). It has been mentioned above that the antigen called HLA-G is released

by trophoblasts, which also has the function of inhibiting the attacks of natural killer cells (Hunt et al., 2017; Keskin, 2012; Zhuang et al., 2021).

A second mechanism is the Fas-Fas ligand (Fas/FasL) interaction. Fas ligand and Fas receptor play an important role in regulating the immune response and even limiting the immune response. Both belong to the tumor necrosis factor family but are classified as different types. Accordingly, their main function is to induce apoptosis (Hunt et al., 2017). The receptor Fas is expressed on highly active T and B cells, natural killer cells and macrophages. FasL is expressed by active T cells and cytotoxic T lymphocytes (Kauma et al., 1999).

The tertiary mechanism is based on the interaction of cytokines (Izgi & Sur, 2009). Different cytokines are produced from different cells in the body based on different needs. This is also the case in pregnancy; some cytokines serve maternal tolerance. For example, Th1 (helper T lymphocytes) cytokines (IL-2, IFN-gamma, TNF-alpha) cause allograft rejection, while cytokines released from Th2 (IL-4,5,6,10 and LIF) suppress Th1 in the fetus. It prevents rejection and indirectly contributes to maternal tolerance (Noci et al., 2005). At the same time, the HLA-G antigen also contributes to the process by decreasing the production of Th1 cytokines and increasing the production of the Th2 cytokine, IL-4 (Keskin, 2012). It participates in the production of TGF-beta and IL-10 cytokines, which suppress the maternal immune system in trophoblast cells (Izgi & Sur, 2009).

Macrophages, lymphocytes, Th2 (type 2 helper T lymphocytes), and T-reg (regulatory T lymphocytes) also serve the system with the different cytokines they secrete (Huang et al., 2020; Izgi & Sur, 2009).

Hormonal mechanisms are also involved. Accordingly, it is known that steroid hormones have a suppressive effect on the proliferation of leukocytes (Izgi & Sur, 2009). It is also known to everyone that progesterone is a hormone necessary for the continuation of pregnancy (Keskin, 2012).

## **Conclusion**

Maternal tolerance is a system in which all possibilities are mobilized for the development of life in an area surrounded by enemies. In this respect, it will continue to be a very interesting subject. However, the mechanisms in this regard have not been elucidated in all aspects due to their rather complex functioning. We believe that more work is needed in this area. More



**4TH INTERNATIONAL LATIN AMERICAN  
CONGRESS ON NATURAL AND APPLIED SCIENCES**

information will be very useful for the discovery of new methods for tissue or organ transplantation procedures and to increase the success rate.

**SOURCE**

- De Lemos, M. A. (2003). How your Mother Tolerated you for Nine Months. *Biol. Teach. Journal*, 1, 27–30.
- Hassa, O., & Aşti, R. (1997). *Embriyoloji* (3rd ed.). Yorum Matbaacılık Sanayi.
- Huang, N., Chi, H., & Qiao, J. (2020). Role of Regulatory T Cells in Regulating Fetal-Maternal Immune Tolerance in Healthy Pregnancies and Reproductive Diseases. *Frontiers in Immunology*, 11, 1–16. <https://doi.org/10.3389/fimmu.2020.01023>
- Hunt, J. S., Petroff, M. G., McIntire, R. H., & Ober, C. (2017). HLA-G and immune tolerance in pregnancy. *The FASEB Journal*, 19(7), 681–693. <https://doi.org/10.1096/fj.04-2078rev>
- Izgi, M., & Sur, E. (2009). Maternal Tolerans. *Ataturk Universitesi Vet. Bil. Derg.*, 4(1), 123–132. <https://dergipark.org.tr/tr/pub/ataunivbd/issue/2907/40207>
- Kauma, S. W., Huff, T. F., Hayes, N., & Nilkaeo, A. (1999). Placental Fas Ligand Expression is a Mechanism for Maternal Immune Tolerance to the Fetus. *Journal of Clinical Endocrinology and Metabolism*, 84(6), 2188–2194. <https://doi.org/10.1210/jc.84.6.2188>
- Keskin, F. (2012). ANNE SERUMUNDAKİ ÇÖZÜNEBİLİR HLA-G DÜZEYLERİNİN MİSSED ABORTUSLAR İLE İLİŞKİSİ. DÜZCE ÜNİVERSİTESİ TIP FAKÜLTESİ.
- McGeady, T. A., Quinn, P. J., FitzPatrick, E. S., & Ryan, M. T. (2011). *Veteriner Embriyoloji* (İ. Çelik & Y. Öznurlu, Eds.). Medipres.
- Noci, I., Fuzzi, B., Rizzo, R., Melchiorri, L., Criscuoli, L., Dabizzi, S., Biagiotti, R., Pellegrini, S., Menicucci, A., & Baricordi, O. R. (2005). Embryonic soluble HLA-G as a marker of developmental potential in embryos. *Human Reproduction*, 20(1), 138–146. <https://doi.org/10.1093/humrep/deh572>
- Özer, A. (2011). *Veteriner Özel Histoloji* (3rd ed.). Nobel Akademi Yayıncılık.
- Straszewski-Chavez, S. L., Abrahams, V. M., & Mor, G. (2005). The Role of Apoptosis in the Regulation of Trophoblast Survival and Differentiation during Pregnancy. *Endocrine Reviews*, 26(7), 877–897. <https://doi.org/10.1210/er.2005-0003>
- Zhuang, B., Shang, J., & Yao, Y. (2021). HLA-G: An Important Mediator of Maternal-Fetal Immune-Tolerance. *Frontiers in Immunology*, 12, 1–19. <https://doi.org/10.3389/fimmu.2021.744324>

**A RARE CASE OF NOVEL MUTATION IN THE KIFBP GENE**

KIFBP GENİNDE NOVEL MUTASYON SAPTANAN NADİR BİR OLGU

**Cüneyd YAVAŞ**

Dr., Başakşehir Çam ve Sakura Şehir Hastanesi

ORCID: 0000-0002-1597-5922

**Savaş BARIŞ**

Uzm. Dr., Aydın Kadın Doğum ve Çocuk Hastalıkları Hastanesi

ORCID: 0000-0003-0139-2520

**ÖZET**

Goldberg-Shprintzen sendromu (GOSHS), zihinsel gelişim bozukluğu, mikrosefali ve dismorfik yüz özellikleri ile karakterize otozomal resesif geçişli çoklu konjenital anomali sendromudur. Çoğu hastada ayrıca Hirschsprung hastalığı ve/veya nöral krest hücreleri ve nöronların göçündeki kusurlarla tutarlı olarak beyinde giral anormallikler vardır. Megalokornea veya ürogenital anomaliler gibi diğer özellikler de mevcut olabilir. Goldberg-Shprintzen sendromu Mowat-Wilson sendromu (MOWS; 235730) ile bazı benzerlikler gösterir ancak genetik olarak farklıdır. Bu gendeki defektlere sahip aile bireyleri farklı fenotipler göstermektedir. KIFBP geninde kodlanan KIF-binding protein proteini periferik ve merkezi sinir sistemi gelişimi sırasında aksonal mikrotübüllerin organizasyonu ve aksonal büyüme ve bakım için gerekli olduğu düşünülmektedir. Sunumumuza konu olan 15 yaşında kadın hasta; boy kısalığı, yürüme bozukluğu ve skolyoz şikayetleri ile genetik tanı merkezimize sevk edildi. Hastaya tüm ekzom dizileme (WES) analizi planlandı ve analiz neticesinde elde edilen genetik varyasyonlar in silico araçların yardımıyla değerlendirildi. Hastada kliniği ile ilişkili olduğu öngörülen KIFBP geni [NM\_015634.4] c.979\_981del (p.Leu327del) varyasyonu homozigot olarak saptandı. Tespit edilen varyasyon, proteinin fonksiyonel bölgesinde bulunan 327. pozisyondaki lösin amino asidinin silinmesine sebebiyet vermektedir. Saptadığımız varyasyon gnomAD, ClinVar ve PubMed taramalarında varyasyona saptanmadığından novel bir varyasyon olduğu düşünülmektedir. KIFBP'nin KIF-1 binding protein C terminal fonksiyonel domainini etkileyerek hücrel metabolizmayı bozan varyasyonlar, hastalarda farklı fenotipik tutulumlar ortaya çıkarabilmekte ve klinik bulguların şiddetiyle de korelasyon gösterdiği düşünülmektedir. Bu bağlamda çalışmamızın literatüre katkı sağlayacağını düşünmekteyiz. Türkiye, Asya ve Avrupa kıtası arasında geçiş noktası olması ve akraba evliliklerinin herhangi bir Ortadoğu ülkesine benzer olması açısından OR hastalıklara dair verilerin dikkatle değerlendirilmesi ayrıca önem taşımaktadır.

**Anahtar Kelimeler:** İskelet bozuklukları, WES, Otozomal resesif, Goldberg-Shprintzen megakolon sendromu.

## **ABSTRACT**

Goldberg-Shprintzen syndrome (GOSHS) is an autosomal recessive multiple congenital anomaly syndrome characterized by impaired intellectual development, microcephaly and dysmorphic facial features. Most patients also have Hirschsprung's disease and/or gyral abnormalities of the brain consistent with defects in the migration of neural crest cells and neurons. Other features such as megalocornea or urogenital anomalies may also be present. GOSHS has some similarities with Mowat-Wilson syndrome (MOWS; 235730) but is genetically distinct. Family members with defects in this gene show different phenotypes. The KIF-binding protein encoded in the KIFBP gene is thought to be essential for the organization of axonal microtubules and axonal growth and maintenance during peripheral and central nervous system development. A 15-year-old female patient was referred to our genetic diagnosis center with complaints of short stature, gait disturbance and scoliosis. Whole exome sequencing (WES) analysis was planned and genetic variations obtained as a result of the analysis were evaluated with the help of in silico tools. The KIFBP gene [NM\_015634.4] c.979\_981del (p.Leu327del) variation, which was predicted to be associated with the patient's clinic, was homozygous. The variation causes deletion of the leucine amino acid at position 327 in the functional region of the protein. The variation is considered to be a novel variation as it was not detected in gnomAD, ClinVar and PubMed databases. Variations that disrupt cellular metabolism by affecting the KIF-1 binding protein C terminal functional domain of KIFBP may lead to different phenotypic involvement in patients and are thought to correlate with the severity of clinical findings. In this context, we think that our study will contribute to the literature. The fact that Turkey is located at a transitional point between Asia and Europe, and that consanguineous marriages are similar to any Middle Eastern country, it is also important to carefully evaluate the data on OR diseases.

**Keywords:** Skeletal abnormalities, WES, Autosomal recessive, Goldberg-Shprintzen megacolon syndrome.

**4TH INTERNATIONAL LATIN AMERICAN  
CONGRESS ON NATURAL AND APPLIED SCIENCES**

**USAGE OF ICP-MS IN BIOLOGICAL SAMPLES**

**BİYOLOJİK ÖRNEKLERDE ICP-MS KULLANIMI**

**Dilara ÜLGER ÖZBEK**

Öğr. Gör. Dr., Sivas Cumhuriyet Üniversitesi

ORCID NO: 0000-0002-6834-020X

**ÖZET**

ICP-MS olarak bilinen indüktif eşleşmiş plazma-kütle spektroskopisi, temel inorganik bileşiklerden olan eser element, mineral ve ağır metaller gibi periyodik tabloda bulunan birçok elementin analizini yüksek seçicilik ve hassasiyetle yapan spektroskopik bir cihazdır. Biyolojik örneklerde elementlerin analizi klinik ve rutin analizler açısından oldukça önem arz etmektedir. Bunun dışında araştırma ve inceleme konusu olarak da son yıllarda literatüre oldukça katkı sağlayan çalışmalar yapılmaktadır. Biyolojik örneklerde ICP-MS'in çok tercih edilme sebebi çok düşük algılama limitlerinde, birçok elementi aynı anda hızlıca ölçme yeteneğine sahip olmasıdır. Biyolojik örneklerde ICP-MS çok tercih edilmesine rağmen, kullanımında çeşitli zorluklar ortaya çıkmaktadır. Bunlar, az miktardaki örnekte hedef türün düşük derişimlerde bulunması, matriks etkisi, kontaminasyon ve çeşitli girişimlerdir. Bunun haricinde ICP MS ile biyolojik örneklerin analiz edilebilmesi için örneklerin sıvı forma dönüştürülmesi ve organik bileşenlerinin büyük çoğunluğunun uzaklaştırılması şarttır. Bu anlamda numune hazırlık aşaması ICP-MS analizlerinde ilk ve en önemli basamaktır. Bu amaçla numune hazırlığında en çok Mikrodalga yakma sistemleri kullanılmaktadır. Farklı tasarımlarda üretilen ICP-MS cihazlarında numunenin direkt olarak cihaza uygulanarak analiz edilmesi biyolojik örneklerde büyük avantaj sağlamaktadır. Yüksek hassasiyeti, aynı anda çok sayıda elementi hızlı bir şekilde analiz edebilme yeteneğiyle de rutin klinik analizlerde ve toksikolojide çok tercih edilen ICP-MS, güçlü ve analitik bir cihazdır. Son yıllarda birçok hastalık ve patolojik durumlarda ICP-MS cihazı ile yapılan araştırmalar hız kazanmıştır.

**Anahtar Kelimeler:** ICP-MS, biyolojik örnekler, eser element

**ABSTRACT**

Inductively coupled plasma-mass spectroscopy, known as ICP-MS, is a spectroscopic device that analyzes many elements in the dream table, such as trace elements, minerals and heavy metals, which are basic inorganic things, with high selectivity and sensitivity. Materials collected from living things such as humans, animals, plants, fungi, bacteria, and model organisms constitute biological sample groups. These materials include; body fluids, tissue,

cells and many other components. Researchers need specific types of biological samples to perform their work and advance medicine. The analysis of elements in biological samples is very important in terms of clinical and routine analysis. Apart from this, studies that have contributed to the literature in recent years have been carried out as a research and examination subject. The reason why ICP-MS is highly preferred in biological samples is that it has the ability to quickly measure many elements simultaneously, at very low detection limits. Although ICP-MS is highly preferred in biological samples, various difficulties arise in its use. These are low concentrations of the target species in a small amount of samples, matrix effect, contamination and various interferences. The most common is the contamination that may occur during sampling and storage. The materials used in the sample collection stage should be carefully selected to avoid elemental contamination and should be plastic. Plastic materials used in sample preparation and collection should be washed with 2% nitric acid. Samples can be stored for a long time at +4-8 °C with pre-treatment, convert to solution and acidification processes. Apart from this, in order to analyze biological samples with ICP MS, it is necessary to convert the samples into liquid form and remove the majority of their organic components. Biological samples cause matrix effect due to their organic components and high salt content. Digestion of the organic part, dilution up to a certain rate, is effective in reducing matrix interactions. In this sense, sample preparation is the first and most important step in ICP-MS analysis. For this purpose, microwave combustion systems are mostly used in sample preparation. Analyzing the sample by applying the sample directly to the device in ICP-MS devices produced in different designs provides a great advantage in biological samples. ICP-MS, which is highly preferred in routine clinical analyzes and toxicology, is a powerful and analytical device with its high sensitivity and ability to quickly analyze many elements at the same time. In recent years, research with the ICP-MS device has gained momentum in many diseases and pathological conditions.

**Key Words:** ICP-MS, biological samples, trace elements

## **GİRİŞ**

Canlı organizmalarda birçok biyokimyasal sürecin yürütülmesinde temel inorganik bileşiklerden olan mineraller ve eser elementlerden faydalanılır (Frausto da Silva JJR, 2001). Biyolojik örneklerin, yaş ağırlığının %1'inden daha az olan elementlere eser element denilmektedir (Bowen, 1988). Eser elementler yaşamsal döngü homeostazındaki rolleri, eksiklikleri veya aşırılıkları sebebiyle çeşitli hastalıklara sebep olabilmektedir ve bu nedenle son yıllarda sıkça araştırılmaya başlanmıştır (Fraga, 2005). Örneğin bu eser elementlerden Çinko (Zn), bakır (Cu) ve Mangan (Mn) birçok enzimin kofaktörleridir ve ayrıca antioksidan olarak işlev görürler (H, 2010). Demir (Fe), santral sinir sisteminin fonksiyonları ve yapısı için hayati önem taşımakla kalmayıp, oksijen transferinin de en önemli kofaktörüdür (JM, 2001). Kobalt (Co), yağ aside metabolizması ve folat için ihtiyaç duyulan B12 vitamini ile bütünleşmiş şekilde bulunmaktadır. Kadmiyum (Cd) çevresel ve mesleki maruziyetlerle birikim gösteren toksik elementlerdendir. Kurşun(Pb) ise, inflamasyona sebep olan, oksidatif stresi tetikleyen, nitrik oksit üretimini azaltan ağır metaldir (Chen PC, 2013). Selenyum (Se),

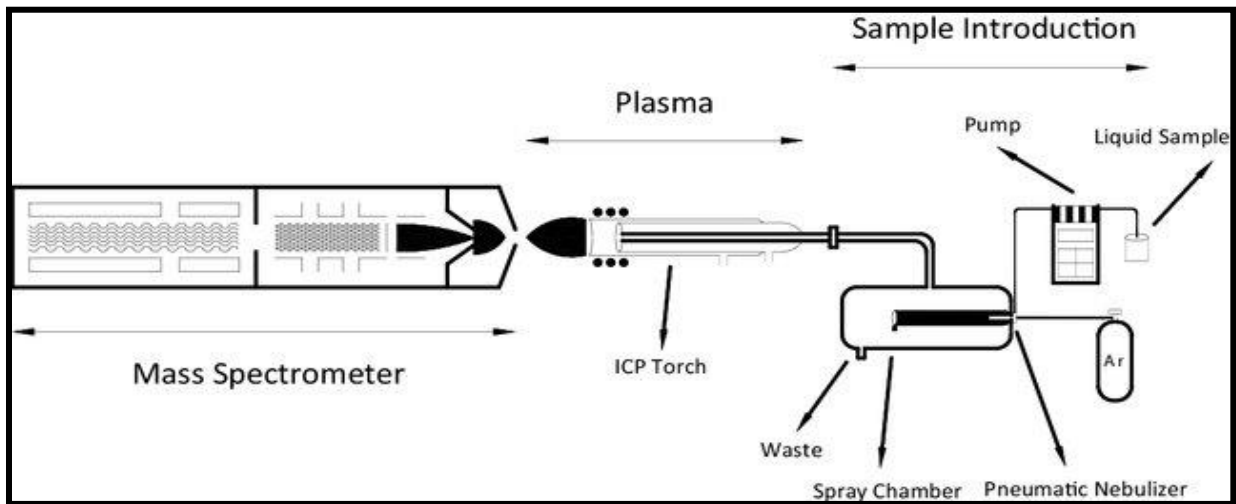
hastalık durumlarında bağışıklık sisteminde rol alır ve hücre zarlarını oksidatif hasardan korur (U,T 2008).

Biyomedikal alanda, eser elementlerin canlılardaki rolleri ve toksik etkilerini araştırmaya yönelik pek çok araştırma yapılmaktadır. Bu anlamda eser elementlerin incelendiği materyaller ise, kan, doku, saç, diş, tırnak, idrar ve çok çeşitli vücut sıvılarını içermektedir. Ancak, biyolojik örnekler matris girişimleri, kontaminasyon, düşük analit ve numune miktarları sebebiyle analiz edilirken güçlük yaşanmaktadır (Tunç, 2006). Bu yüzden biyolojik örneklerde eser element içeriklerini belirleyebilmek ve doğru bilgiye ulaşmak için, uygulanması kesinleşmiş yöntemlerinin kullanılması mecburidir (Ivanenko, 2011).

Biyolojik örneklerde farklı teknik, seçicilik ve hassasiyetle element analizi yapan çeşitli spektroskopik cihazlar vardır. Çoğunlukla, atomik absorpsiyon spektrometresi (AAS), indüktif eşleşmiş plazma atomik emisyon spektrometresi (ICP-AES) aynı zamanda indüksiyonla birleşmiş plazma optik emisyon spektroskopisi (ICP-OES) olarak da bilinir, Xray floresan analizi (XFA veya XRF) ve indüktif eşleşmiş plazma kütle spektrometresi (ICP-MS) kullanılmaktadır. Nadir olarak da Sıyırma voltametresi (SVA) ve nötronaktivasyon analizi (NAA) kullanılmaktadır (Ivanenko, 2011). Biyolojik örneklerde eser element tayini için bu cihazlardan en çok ICP-MS kullanılmaktadır. Sebebi yüksek hassasiyet ve çoklu element analizine imkân sunmasıdır.

### 1.ICP-MS Cihazının Genel Özellikleri ve Bileşenleri

İndüktif eşleşmiş plazma-kütle spektrometresi (ICP-MS), biyolojik örnekler başta olmak üzere birçok numunenin çok düşük konsantrasyonlarda ( $\mu\text{g/L}$ ,  $\text{ng/L}$ ), birçok elementin aynı anda analiz edilmesini sağlayan gelişmiş analitik bir yöntemdir. Yöntemin ana prensibi, çözelti halindeki örneğin, argon gazı ile plazmaya gönderilmesi ve burada yüksek sıcaklıkta (8000-10000 Kelvin) iyonlaştırılan elementlerin kütle/yük ( $m/z$ ) oranına göre de kütle spektrometre (MS) ünitesinde tespit edilmesine dayanmaktadır (Bahadır, 2020).



Şekil-1: ICP-MS ana bileşenler şeması (Kashani, 2010).



Günümüzde farklı dizaynlarda ICP-MS cihazları bulunsa da, birçoğunun ana bileşenleri aynıdır ve ayrı bir ünitesi olmadıkça sadece sıvı örneklerin analizini gerçekleştirebilmektedirler. Örneğin sprej odası, nebulizatör, plazma torcu, dedektör tüm ICP-MS cihazlarında ortak bileşenlerdir. Sıvı numune peristaltik pompa aracılığıyla sisleştirilmek üzere nebulizatöre gönderilir. Numune burada argon gazı ile aerosol şeklinde sprej odasına püskürtülür. Numune aerosolü quartz torch bölümünden plazmaya ulaşır. Quartz torch RF sarmalı denen, yüksek radyo frekansı oluşturan bakır bobinler içinden geçmektedir. Bu yüksek manyetik alandaki voltajlı kıvılcım ve torch içinden geçen argon gazı molekülleri çarpışmaktadır ve yüksek sıcaklıkta plazma oluşmaktadır böylelikle tüm elementler iyonlaşmaktadır. Pozitif yüklü iyonlar nikel cone lardan geçerek iyon lensine ulaşır. İyonlar kütle dedektörüne girmeden önce girişim yapan iyonların uzaklaştırılması amacıyla çarpıştırma hücrelerinde inert bir gaz olan helyum veya hidrojen ile çarpıştırılarak uzaklaştırılır. Ardından kütle analizöründe iyonlar kütle/yük oranına göre ayrılır, sadece kararlı iyonlar dedektöre iletilirler (Tunç, 2006).

### **1.1. ICP-MS kullanımının avantajları**

ICP-MS, mükemmel duyarlılığı, seçiciliği ve izotop belirleme potansiyeli ile eser element analizlerinde önemli bir yer etmiştir. Çok sayıda elementi eş zamanlı olarak hızlı bir şekilde tayin edebilmektedir. Cihaz tasarımına göre, tek enjeksiyonla belirlediğiniz kadar (örneğin 1-5) okuma yapabilmektedir. Oto örnekleme ünitesi sayesinde, çok sayıda örneği hızlı bir şekilde enjekte ederek analiz edebilmektedir. Girişim yapan türleri uzaklaştırmak adına inert gazlar ile çarpıştırma ve girişim engelleme özelliğine sahiptir (Zoorob, 1998).

### **1.2. ICP MS kullanımının dezavantajları**

- ✓ Nispeten yüksek sermaye maliyeti
- ✓ Yüksek operatör deneyim gereksinimi
- ✓ Toplam Çözünmüş Katılar < 0.2% (TDS)
- ✓ Matriks girişimleri
- ✓ İzobarik girişimler
- ✓ Sapma/belirsizlik
- ✓ Nispeten yüksek işletme maliyetleri
- ✓ Daha yüksek konsantrasyonlar için "çok hassas" olabilir (Tyler, 1995).

### **1.3. ICP-MS kullanımında girişimler**

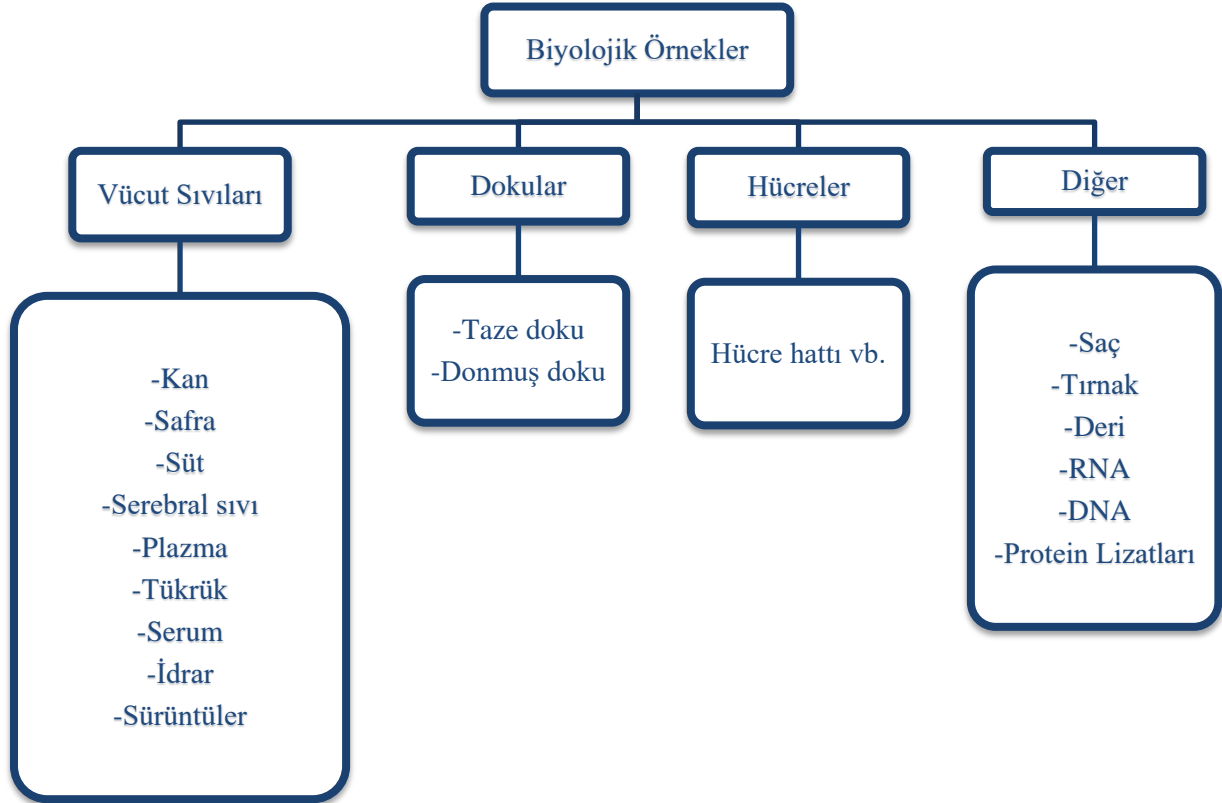
ICP-MS'de spektral ve spektral olmayan iki tür girişim söz konusudur. Spektral girişimlerde plazmadaki hedef tür iyonunun m/z oranı ile iyonik türün m/z oranının çakışmasıyla oluşur. Spektral olmayan girişimler ise matriksten kaynaklanmaktadır. Yoğun sinyal sebebi ile atom kütlelerinin baskılanması ile oluşur. Matriks etkisinin oluşumunu 500-1000 mg/mL den çok olan girişimsel türlerin derişimi sebep olmaktadır.

1. Spektral Girişimler:
  - ✓ Elementel izobarik girişimler
  - ✓ Çift yüklü türler
  - ✓ Çok Atomlu Girişimler
  - ✓ Artık Müdahaleleri
2. Spektral Olmayan Girişimler:
  - ✓ Matris
  - ✓ Boşluk yükü etkisi
  - ✓ Fiziksel
3. Diğer
  - ✓ Bellek etkisi
  - ✓ Kirlilik problemleri (Balaram, 2021).

## 2. Biyolojik Örneklerin ICP-MS'de Analizi

İnsan, hayvan, bitki, mantar, bakteri ve model organizmalar gibi canlılardan toplanan materyaller biyolojik numune gruplarını oluşturur. Bu materyaller; vücut sıvıları, doku, hücreler ve diğer birçok bileşeni kapsamaktadır. Araştırmacılar, çalışmalarını gerçekleştirmek ve tıbbi ilerletmek için belirli türde biyolojik örneklere ihtiyaç duyarlar.

Biyolojik örneklerin elementel analizi oldukça meşakkatlidir. Biyolojik örneklerin düşük hacim ve analit içeriklerinden dolayı, elementel analizlerinden sağlıklı sonuç alabilmek için örneklerin toplanması ve analize hazırlanması işlemleri büyük önem arz etmektedir.



Şekil-2: Biyolojik örnek sınıflaması

## **2.1. Biyolojik Örneklerin Toplanması**

Uygulanan yöntemden bağımsız olarak, biyolojik örneklerin analizinin en genel sorunu, numune alımı ve saklama sırasında oluşabilecek olan kirliliklerdir. Kan örneklerinin toplanmasını ele alacak olursak, ilk aşamada kan alımı için kullanılan enjektörlerde Al, Cr, Ni ve Zn kontaminasyonu riski vardır. Bunun önüne geçmek için plastik venöz kanül kullanımı tavsiye edilmektedir (Orbelis, 2008). Alınan kanın hemolizli olması da ayrıca serumdaki Fe, Cu, Zn, Pb, Rb, Mn ve Mg konsantrasyonlarını arttırdığından bu aşama da oldukça dikkatli olunmalıdır (Bertram, 1992). Kan alındıktan sonra saklanacak tüplerde oldukça önemlidir. Antikoagülan içeren tüplerin numuneyi kontamine etme riski de oldukça yüksektir (Ivanov, 2009). Bu nedenle lacivert kapaklı eser element tüpleri ile Fe, Zn, Cu, Hg, Pb gibi eser elementlerin tayininde kullanılmaktadır. Pıhtı aktivatörü olarak, K<sub>2</sub>Edta ya da Na-heparin içermektedir. Eser element analizine kullanılan bu tüplerde Na ve K analizi uygun olmaz.



Şekil-2: Eser element Analiz Tüpü

Doku vb diğer numunelerin toplanmasında da benzer kontaminasyonlar söz konusudur. Dokulardan kesit alınırken kullanılan bisturi, sonrasında saklanacakları kapların temiz ve elementel girişime sebep olmaması önemlidir.

Toplanan numunelerin ön işlem aşamalarında kullanılan teflon tüpler, pipet uçları, enjeksiyon tüplerinin temizliği de elementel analiz aşamalarında oldukça önemlidir.

## **2.2. Biyolojik Örneklerin Analize Hazırlanması**

Biyolojik numunelerin karmaşık matris bileşimi (organik bileşenler, yüksek tuz içeriği gibi) çoğunlukla numune hazırlama aşamasının analiz prosedüründen çıkarılmasına izin vermez. Uygulanan yöntemlerin seçiciliğine bağlı olarak numune hazırlama, basit numune seyreltmesinden numunenin termal veya mikrodalga parçalanması gibi adımlar izlenebilir. Numunenin organik kısmının parçalanması, belli bir orana kadar seyreltme matriks etkileşimlerinin azaltılmasında etkilidir. (Ivanenko, 2011). Bununla birlikte, biyolojik dokuların ICP-MS ile analizi için, katı numunenin ayrışma prosedürü ve numunenin ICP'ye eklenmesinden önce bunun homojen bir sıvı faza dönüştürülmesi genellikle gereklidir. Analiz öncesinde numuneler genellikle asit ortamında parçalanır. Açık veya kapalı kaplarda yaş yakma metotları, mikrodalga destekli asitli parçalama ile çeşitli numunelerde başarılı olmasına rağmen mikrodalga sistemlerinin birkaç dezavantajı da vardır. En önemlisi çoklu

numunelerde kullanımı kısıtlıdır, sebebi ise mikrodalga rotorlarının her döngüde sınırlı olan örnek kapasitesidir. Bir diğeri ise, kullanılan kaplarda kalan kirliliklerin birkaç kez temizleme döngüsüne tabii tutulması gerekliliğidir (Batista, 2009). Bu yüzden az zaman ve emekle daha çok örneğin ön hazırlığı arzu edilir bir durumdur.

Bunlar dışında, cihaz tasarımlarına göre değişkenlik gösteren birçok metot bulunmaktadır. Bazı cihazlarda numunenin direk enjekte edildiği aparatlar mevcutken (Sussulini, 2017), bazı cihazlar için farklı kimyasallar ile muamele sonrası enjeksiyona imkân sağlayan metotlar ve tasarımlar mümkündür (Batista, 2009).

### **2.3.Sonuç**

ICP-MS de biyolojik örneklerin analiz edilmesi son yıllarda kapsamlı bir şekilde kullanılmaktadır. Özellikle kan ve idrarda seviyeleri artan elementlerin kronik ve akut maruziyetlerini belirlemek adına oldukça faydalıdır. ICP-MS de çoklu ve tekli elementlerin özellikle klinik toksikoloji ve rutin analizlerde kullanımı hayati önem taşımaktadır (Goullé, 2014).

Biyolojik örneklerde elementel analize imkân sağlayan güçlü, analitik bir cihazdır.

- ✓ Oldukça hassastır
- ✓ Çok sayıda elementin tek seferde eş zamanlı tayiniyle toksikolojik vakalarda hızlı sonuç sağlamaktadır.
- ✓ Gruplara göre yöntem uygulanabilirliği çok iyidir.
- ✓ Donanım ve yazılımında düzeltme denklemlerinin kullanımıyla hassasiyet ve özgüllüğü de artırmaktadır.

### **Kaynakça**

- Bahadır, Z. (2020). Atık Su Örneklerinde Bazı Ağır Metallerin İndüktif Eşleşmiş Plazma Kütle Spektrometresi ile (ICP-MS) Tayini. *Journal of Anatolian Environmental and Animal Sciences*, 56-60.
- Batista, B. L. (2009). Determination of trace elements in biological samples by inductively coupled plasma mass spectrometry with tetramethylammonium hydroxide. *plasma mass spectrometry with tetramethylammonium hydroxide*, 23-29.
- Balaram, V. (2021). Strategies to overcome interferences in elemental and isotopic geochemical analysis by quadrupole inductively coupled plasma mass spectrometry: A critical evaluation of the recent developments. . *Rapid Communications in Mass Spectrometry*.
- Bertram, H. (1992). Spurenelemente: Analytik, Okotoxikologische und Medizinisch. *Klinische Bedeutung, Muenchen: Wien, Baltimore, Urban und Schwarzen berg*.
- Bowen, H. J. (1988). Trace elements in biological samples. (Vol. 8, pp. 1-17). Elsevier. Bowen içinde, *In Techniques and Instrumentation in Analytical Chemistry* (s. 1-17). England: elsevier.
- Chen PC, e. a. (2013). Blood trace minerals concentrations and oxidative stress in patients with obstructive sleep apnea. *J Nutr Health Aging*, 639-644.

**4TH INTERNATIONAL LATIN AMERICAN  
CONGRESS ON NATURAL AND APPLIED SCIENCES**

- Fraga, C. G. (2005). Relevance, essentiality and toxicity of trace elements in human health. . *Molecular aspects of medicine*, 235-244.
- Frausto da Silva JJR, W. R. (2001). *The biological chemistry of the elements*. Oxford: Oxford University Press.
- Goullé, J. P. (2014). Current role of ICP–MS in clinical toxicology and forensic toxicology: a metallic profile. *Bioanalysis*, 2245-2259.
- H, V. e. (2010). Alterations of plasma magnesium, copper, zinc, iron and selenium concentrations and some related erythrocyte antioxidant enzyme activities in patients with Alzheimer’s disease. *J Trace Elem Med Biol*, 169-173.
- Ivanenko, N. B. (2011). Determination of trace elements in biological fluids . *Journal of analytical chemistry*, 784-799.
- Ivanov, V. M. (2009). *Toksikologicheskaya khimiya. Metabolizm i analiz toksikantov (Toxicological Chemistry: Toxicant Metabolism and Analysis)*, A textbook for higher schools, Kaletina, NI, Ed. 206: Journal of Analytical Chemistry.
- JM, O. (2001). Trace elements and DNA damage. *Biochem Soc Trans*, 354-357.
- Kashani, A. &. (2010). Aerosol characterization of concentric pneumatic nebulizer used in inductively coupled plasma-Mass spectrometry (icp-ms). *Atomization and Sprays*, 415-433.
- Orbelis, D. K. (2008). *Biolog icheseskaya rol’ makro i mikroelementov u cheloveka i zhyvotnykh (Biological Role of Macro and Microelements in Human and Animals)* . St. Petersburg: Nauka.
- Sussulini, A. B. (2017). Laser ablation ICP-MS: Application in biomedical research. . *Mass spectrometry reviews*, 47-57.
- Tunç, M. (2006). *Biyolojik sıvılarda bazı eser elementlerin tayini ve metot geliřtirme*. Yıldız Teknik Üniversitesi, Fen Bilimleri Enstitüsü.
- Tyler, G. &. (1995). ICP-OES, ICP-MS and AAS Techniques Compared. *ICP Optical Emission Spectroscopy Technical Note*, 5
- U.T. (2008). Selenium: its role as antioxidant in human health. *Environ Health*, 102-108.
- Zoorob, G. K. (1998). ICP-MS for elemental speciation studies. *Microchimica Acta*,, 145-168.

**4TH INTERNATIONAL LATIN AMERICAN  
CONGRESS ON NATURAL AND APPLIED SCIENCES**

**INVESTIGATION OF THE BLOOD MICROBIOME PROFILE**

**KAN MİKROBİYOM PROFİLİNİN ARAŞTIRILMASI**

**Süleyman Görgüç**

Akdeniz University Tuberculosis Research Center.

ORCID: 0009-0002-3781-7113

**Cemilenur Ataş**

Akdeniz University Tuberculosis Research Center.

ORCID: 0000-0003- 3661-1017

**Kübra Yıldırım**

Phd, Akdeniz University Tuberculosis Research Center.

ORCID: 0000-0003-0558-9619

**Ece Şimsek**

Assoc. Prof. Dr., Akdeniz University Tuberculosis Research Center.

ORCID: 0000-0002-7642-6601

**Ahmet Yılmaz Çoban**

Prof. Dr. Akdeniz University Tuberculosis Research Center.

ORCID: 0000-0002-8815-6063

**ÖZET**

Damarlarımızda sürekli olarak akan kan, hayatta kalmamız için gerekli olan çok sayıda işlevi yerine getirir. Bu geniş dolaşım sistemi oksijen dağıtımının yanı sıra besin taşınmasını kolaylaştırır, enfeksiyonu önler ve ısıyı vücudumuza dağıtır. İnsan kanının ~%54,3'ü plazma, ~%45'i kırmızı kan hücreleri (eritrositler), ~%0,7'si beyaz kan hücreleri ve trombositler oluşur. İnsan mikrobiyomu bakteriyel, arkeal, viral ve fungal mikrobiyal taksonlardan oluşan geniş bir mikrobiyom içermektedir. İnsan kanının sadece kan hücreleri, trombositler ve plazmadan oluşan tamamen steril bir ortam olduğu düşünüldüğünden, kanda mikrop tespit edilmesi sürekli olarak enfeksiyon göstergesi olarak yorumlanmıştır. Ancak, insan kan mikrobiyomu tartışmalı bir konu olmasına rağmen, insan kan mikrobiyomunun varlığına dair kanıtlar giderek artmaktadır. Bu mikroorganizmaların kökenleri, kimlikleri ve işlevleri aydınlatılmayı beklerken, kan kaynaklı mikrobiyal filogeniye ilişkin bilgiler giderek artmaktadır. İnsan mikrobiyomunun keşfedilmesi, Yeni Nesil Dizileme (NGS) ve tüm metagenom shotgun dizilemenin (WMGS) farklı insan vücut bölgelerinde bulunan mikrobiyal



genetik materyali incelemek için yeni teknikler olarak ortaya çıkmasıyla büyük ölçüde kolaylaştırılmıştır. 16S hedefli metagenomik dizileme gibi yenilikçi analitik teknolojilerin uygulanması, hastalıklı olmayan bir insan kan mikrobiyomunun varlığına dair giderek daha sağlam kanıtlar sağlamıştır. Burada pek çok patojenin kanda ve eritrositlerin içinde hayatta kalabildiğinin altını çiziyoruz. İnsan kanında yabancı mikroorganizmaların varlığının mutlaka enfeksiyon veya hastalıklı bir durumla eşdeğer olmadığı fikrini araştıran çalışmaların sayısının giderek arttığı göz önüne alındığında, sağlıklı insan kan mikrobiyomunun keşfi ve geçici olarak kabul edilmesine ilişkin kanıtları gözden geçiriyoruz.

**Anahtar Kelimeler:** insan mikrobiyomu, yeni nesil dizileme, bakteriyel

## **ABSTRACT**

The blood that flows continuously through our veins performs a multitude of functions that are essential for our survival. This extensive circulatory system facilitates oxygen delivery as well as nutrient transport, prevents infection and distributes heat throughout our body. Human blood consists of ~54.3% plasma, ~45% red blood cells (erythrocytes), ~0.7% white blood cells and platelets. The human microbiome includes a wide range of bacterial, archaeal, viral and fungal microbial taxa. Since human blood is thought to be a completely sterile medium consisting only of blood cells, platelets and plasma, the detection of microbes in the blood has consistently been interpreted as an indicator of infection. However, although the human blood microbiome is a controversial topic, there is growing evidence for the existence of the human blood microbiome. While the origins, identities and functions of these microorganisms remain to be elucidated, there is increasing knowledge on bloodborne microbial phylogeny. The discovery of the human microbiome has been greatly facilitated by the emergence of Next Generation Sequencing (NGS) and whole metagenome shotgun sequencing (WMGS) as new techniques to study microbial genetic material present in different human body sites. The application of innovative analytical technologies such as 16S-targeted metagenomic sequencing has provided increasingly robust evidence for the existence of a non-diseased human blood microbiome. Here we underline that many pathogens can survive in blood and erythrocytes. Given the growing number of studies exploring the idea that the presence of foreign microorganisms in human blood does not necessarily equate with infection or a diseased state, we review the evidence for the discovery and tentative acceptance of a healthy human blood microbiome.

**Keywords:** human microbiome, next-generation sequencing, bacterial

## **INTRODUCTION**

The term "microbiome" describes the genetic material that encodes the diverse microbial populations living in our bodies. In contrast, the term "microbiota" refers to the living organisms that make up these communities. The microbiome undertakes fundamental biological processes and it is therefore not surprising that a number of disease states are associated with changes in the composition of the microbiome, the so-called "dysbiosis". While the colonization by microorganisms of specific body sites in contact with the external environment (such as the gastrointestinal tract, skin and vagina) is both well defined and universally accepted (Markova, 2017), the presence of microbial populations in other "considered sterile" locations, including blood, is a relatively new concept. The human microbiome includes a wide range of bacterial, archaeal, viral and fungal microbial taxa. Most of these microorganisms are commensal, but many are mutualistic and some are pathogenic. In fact, despite being smaller than human cells, bacteria make up ~2% of adult human body mass (Molina and DiMaio, 2012). Human microbiome research, defined as the study of the entire DNA content of microorganisms living in our bodies, has developed rapidly in recent years. As this topic has been extensively reviewed elsewhere (Cho and Blaser, 2012; Morgan et al, 2012; Kim et al, 2013; Khanna and Tosh, 2014; Lloyd-Price et al, 2016), we focus here on the available evidence demonstrating the existence of a "healthy" human blood microbiome. In addition, we investigate the potential origins and identities of "resident" microorganisms, their phylogenetic links, and the clinical significance of an allegedly healthy human blood microbiome. We also address the negative impact of contaminants from reagents and laboratory environments on sequence-based gut microbiome and human blood microbiome research and the recovery of numerous microbial taxa in DNA extraction and library preparation controls.

Recently, the possibility of the existence of a human blood microbiome has aroused great interest in the scientific community (McLaughlin et al., 2002; Bahrani-Mougeot et al., 2008; Païssé et al., 2016). Human blood consists of ~54.3% plasma, ~45% red blood cells (erythrocytes), ~0.7% white blood cells and platelets (Alberts et al., 2002). Erythrocytes are primarily responsible for oxygen transportation, while lymphocytes serve as a highly effective surveillance system that monitors the blood for invading microbes (Jerne, 1973). The primary function of platelets is to respond to bleeding from blood vessel damage by clotting (Blache, 1992). As blood has traditionally been considered a sterile environment devoid of all other foreign cells, it is not surprising that the concept of a healthy human blood microbiome has been met with criticism (Nikkari et al., 2001; McLaughlin et al., 2002; Païssé et al., 2016).

The presence of bacterial-specific DNA in blood has been reported in the literature for some time, but its true origin is still a much debated topic. There is a large body of evidence supporting the presence of the blood microbiome (specifically the presence of bacterial genetic material) in humans (Nikkari et al, 2001; Amar et al, 2013; Rajendhran et al, 2013; Dinakaran et al, 2014; Kell and Pretorius, 2015; Potgieter et al, 2015; Mangul et al, 2016;

## **4TH INTERNATIONAL LATIN AMERICAN CONGRESS ON NATURAL AND APPLIED SCIENCES**

Païssé et al, 2016; Bhattacharyya et al, 2017; Li et al, 2018). This has primarily been determined by amplification and sequencing of the bacterial 16S rRNA gene or by whole genome sequencing. Such studies report the presence of circulating bacterial-derived genetic material (DNA), but do not provide evidence for the presence of living organisms.

### **STUDIES ON BLOOD MICROBIOME**

Discussions on the occurrence of foreign cells in human blood date back to the late 1960s when Tedeschi et al. (1969) reported the presence of metabolically active bacteria in the blood of healthy human samples. Recent evidence for the presence of a healthy human blood microbiome comes from Nikkari et al. (2001) who reported the presence of bacterial DNA in the blood of a healthy human cohort. This study, based on qPCR, used rRNA-specific fluorescent probes and primers specific for the 16S rRNA gene and identified bacterial taxa belonging to five divisions and seven phylogenetic groups. However, this study is limited by the fact that all observations were based on analyzing the blood of only four individuals. Shortly thereafter, McLaughlin et al. (2002) described the presence of pleomorphic bacteria in the blood of individuals without any clinical signs of disease. In this study, sequencing of 16S rRNA and *gyrB* genes amplified by PCR confirmed the presence of bacterial DNA in the blood of healthy individuals. In parallel, Moriyama et al. (2008) contributed to the concept of a "healthy" human blood microbiome by confirming the presence of bacterial 16S rRNA genes in the blood of healthy humans. As expected, questioning the traditional belief that blood is sterile in healthy humans under normal conditions has led to considerable controversy. Mitchell et al. (2016), evaluating the results of McLaughlin et al. (2002) and other studies, concluded that the pleomorphic bacteria detected in the blood of healthy people are actually nothing more than microparticles derived from lysed erythrocytes. Although visual confirmation of microorganisms found in the blood of healthy individuals requires further investigation, evidence confirming the presence of microbial genetic material in the circulatory system is accumulating (McLaughlin et al., 2002; Moriyama et al., 2008; Païssé et al., 2016).

By convention, blood is sterile when healthy, and bacteremia is potentially life-threatening even with 1-10 bacterial cells per milliliter of whole blood. Despite this, many studies have provided evidence of circulating bacteria or bacteria-like structures in the absence of overt disease. It should be noted, however, that Martel et al. (2017) reported that following a series of imaging techniques, the bacteria-like particles usually identified represent non-viable membrane vesicles and protein aggregates derived from the blood itself. Potgieter et al (2015) identified the presence of blood cell-associated bacteria in a series of blood preparations using electron microscopy. Damgaard et al (2015) found viable bacteria in 62% of blood donations from donors without any apparent disease.

Kell and Pretorius (2015) suggest that the blood microbiome is likely composed of organisms (or parts thereof) that circulate from their normal habitats (classical niches such as the

gastrointestinal tract, oral cavity, skin, vagina). This explanation is supported by studies showing a correlation between gut microbiota and microbial findings detected in blood (Ono et al., 2005; Sato et al., 2014; Lelouvier et al., 2016), suggesting that the observed disease-associated blood microbiota is a result of increased bacterial translocation across the gut barrier.

### **ORIGIN OF MICROORGANISMS IN THE BLOOD MICROBIOME**

Several disease states are associated with blood microbiome dysbiosis (Amar et al., 2013; Sato et al., 2014; Lelouvier et al., 2016; Mangul et al., 2016; Ling et al., 2017). These changes likely reflect dysbiosis in remote areas with microbial communities. Limited evidence suggests that these changes may also be disease-specific; for example, Alzheimer's disease is mostly associated with the detection of cocci, whereas Parkinson's disease has been associated with both cocci and bacilli (Potgieter et al., 2015).

Because of the long-held view that the bloodstream of healthy individuals is sterile, understanding whether and how bacteria persist in blood is of fundamental importance. Accidental contamination during blood collection or subsequent experimental procedures has been proposed as an alternative explanation for the presence of the blood microbiome. We support this explanation for the detection of viable bacteria in the bloodstream of healthy individuals. Furthermore, examination of the bacterial taxa reported in these studies reveals similar blood microbiota compositions across different studies, with Proteobacteria predominating (relative abundance values typically ranging from 85 to 90%) and Firmicutes, Actinobacteria and Bacteroidetes present to a lesser extent (Amar et al., 2013; Lelouvier et al., 2016; Païssé et al., 2016; Olde Loohuis et al., 2018). This suggests the presence of an ongoing blood microbiome profile independent of the working environment or the analytical methods used.

Some researchers suggest that the presence of bacteria in the blood is the result of transport from other body sites, particularly the gastro-intestinal tract (Païssé et al., 2016). Indeed, the etiology of diabetes, cardiovascular diseases, hematologic disorders and cirrhosis has been attributed to the transport of bacteria through the intestinal tract, particularly through the intestinal epithelial mucosa (Amar et al., 2013; Dinakaran et al., 2014; Sato et al., 2014; Manzo and Bhatt, 2015; Traykova et al., 2017). In parallel, it has been suggested that bacteria derived from the skin (Cogen et al., 2008) and oral microbiomes can also spread into the blood when the barriers between these environments and the circulatory system are compromised (Forner et al., 2006; Bahrani-Mougeot et al., 2008; Iwai, 2009).

Although fetal and maternal blood do not mix during pregnancy, bacteria can colonize the fetal circulatory system even before birth. Jiménez et al (2005) suggested that a prenatal blood microbiome temporarily exists after isolating bacterial DNA from the umbilical cords of healthy infants born by caesarean section. Blood from 20 newborns was collected and

## **4TH INTERNATIONAL LATIN AMERICAN CONGRESS ON NATURAL AND APPLIED SCIENCES**

processed in a class II safety cabinet to prevent contamination. Then, 16S rRNA gene sequencing was performed from colonies obtained after culturing in brain and heart infusion broth (Jiménez et al., 2005). Appropriate negative controls were included in the culturing and sequencing steps. The presence of microorganisms in the blood of newborn infants may be derived from other body sites in utero, such as the fetal gut or oral regions. Therefore, it is widely thought that the initial microbiome of the newborn infant originates from contact with the mother's vaginal, fecal or skin microbiota during birth and that this infant microbiome is subsequently enriched through breastfeeding (Penders et al, 2006; Biasucci et al, 2008; Dominguez-Bello et al, 2010; Azad et al, 2013).

It is clear that the precise origin of the human blood microbiome remains to be fully elucidated. Hypothetically, it could originate from the mother before birth or from the displacement of microorganisms derived from other sources after birth and during the normal human life cycle. In any case, recent findings based on cross-sectional studies predominantly targeting the 16S rRNA gene indicate a group of dominant blood-borne bacterial phyla (i.e. Proteobacteria, followed by Actinobacteria, Firmicutes and Bacteroidetes) (McLaughlin et al, 2002; Amar et al, 2011, 2013; Dinakaran et al., 2014; Gosiewski et al., 2016; Paissé et al., 2016; Loohuis et al., 2018; Whittle et al., 2018; Qiu et al., 2019) and is indicative of long-term human blood microbiome stability.

In relation to the location of microorganisms in human blood, available evidence suggests that bacterial taxa can live inside both erythrocytes and leukocytes. Gresham et al. (2000) showed that bacteria both live and maintain their virulence within neutrophils. When Paissé et al. (2016) analyzed the blood microbiome of healthy individuals, they found that most bacterial DNA (93.74%) was localized in the buffy coat (BC), which is mainly composed of WBCs and platelets.

Although there is growing evidence for the presence of bacterial taxa that make up a healthy blood microbiome in humans, not much is known about the presence of other microorganisms such as viruses, Archaea and fungi in the blood of healthy humans. Since the presence of fungi in the blood of healthy individuals was recently reported (Panaiotov et al., 2018), more studies on the human blood mycobiome are needed. Regarding the human blood virome, Moustafa et al. (2017) obtained 19 viral taxa from 42% of apparently healthy individuals, after removal of taxa due to contamination. Previous reports have confirmed the presence of viruses in healthy human blood, such as rhabdoviruses (Stremlau et al., 2015), anelloviruses (Furuta et al., 2015) and other groups such as Herpesviridae and Poxiviridae (Rascovan et al., 2016). Therefore, additional research on the human blood microbiome is needed to determine whether viruses are a permanent member of the human blood microbiome or simply remnants of previous infections.

### **IMPORTANCE OF MOLECULAR TECHNIQUES IN BLOOD MICROBIOME RESEARCH**



Using a suite of complementary molecular and classical molecular biology techniques, the human circulating microbiome was characterized in detail; at the DNA level, the 16S rRNA gene was amplified and sequenced, while at the RNA level, almost 500,000,000 unmapped mRNA reads were assembled and mapped to known taxa.

The discovery of our "microbial self" has been greatly facilitated by the emergence of Next Generation Sequencing (NGS) and whole metagenome shotgun sequencing (WMGS) as novel techniques to study microbial genetic material present in different human body regions (Segata et al., 2013). In this context, several large-scale population-based studies have sequenced the human gut microbiome as well as the metagenomes of other medically relevant body regions, including the skin, vagina and mouth.

The application of advanced analytical technologies such as targeted NGS of the 16S rRNA gene has provided increasingly robust evidence for the existence of a non-diseased human blood microbiome (Dinakaran et al., 2014; Damgaard et al., 2015; Gosiewski et al., 2016; Païssé et al., 2016; Kowarsky et al., 2017; Whittle et al., 2018; Qiu et al., 2019). RNA sequence data also helped this proposition as bacterial transcripts were identified in healthy control groups (Loohuis et al., 2018; Whittle et al., 2018). Researchers who characterized the blood microbiome of diseased individuals largely by culture-independent methods also detected genetic material in healthy control groups. Moreover, the presence of similar bacterial phyla in different studies seems to support the existence of a healthy human blood microbiome (McLaughlin et al., 2002; Amar et al., 2011, 2013; Dinakaran et al., 2014; Païssé et al., 2016; Li et al., 2018; Loohuis et al., 2018; Whittle et al., 2018; Qiu et al., 2019).

Many microorganisms naturally present in human blood may actually be in an inactive state (Potgieter et al., 2015). Thus, culture-based methods cannot be reliably used to confirm the presence of the human blood microbiome. Moreover, even if the concentration of bacterial DNA in blood is very low, increasingly sensitive analytical methods, especially qPCR and targeted NGS, can confirm existing evidence for the presence of "harmless" bacterial taxa in the blood of healthy humans (Païssé et al., 2016). This is particularly problematic as the detection of too many microbial genera in DNA extraction and material preparation controls (Salter et al., 2014; Lauder et al., 2016) demonstrates the impact of contaminants from reagents and laboratory environments on sequence-based human blood microbiome analyses. Analyses of negative DNA extraction controls by Moriyama et al. (2008) showed significantly less 16S rRNA gene amplification compared to blood from healthy individuals.

It is clear that further studies are required to determine whether microbial DNA and RNA present in healthy human blood represent living or dead bacterial taxa. Although human contamination poses a significant challenge for blood microbiome studies, bacteriological activity in blood can be examined by viability testing techniques such as propidium



monoazide (PMA) treatment and cellular energy measurements (Emerson et al., 2017). However, there is currently no specific and reliable way to detect live bacteria in human blood.

## **CONCLUSION**

Although the existence of the blood microbiome in healthy humans seems to be supported by recent studies, knowledge of the phylogenetic diversity of bloodborne bacteria is still limited. In contrast to the dominant bacterial phylum (i.e. Firmicutes and Bacteroidetes) usually observed in the human gut microbiome, the blood microbiome appears to be dominated by the phylum Proteobacteria, followed by Actinobacteria, Firmicutes and Bacteroidetes (McLaughlin et al, 2002; Amar et al, 2011, 2013; Dinakaran et al, 2014; Gosiewski et al, 2016; Païssé et al, 2016; Li et al, 2018; Loohuis et al, 2018; Whittle et al, 2018; Qiu et al, 2019).

There is increasing evidence pointing to the presence of a microbial component in the blood of healthy humans and recent studies have identified similar bacterial phyla in the blood of healthy individuals (McLaughlin et al, 2002; Amar et al, 2011, 2013; Dinakaran et al, 2014; Gosiewski et al, 2016; Païssé et al, 2016; Li et al, 2018; Loohuis et al, 2018; Whittle et al, 2018; Qiu et al, 2019). Regardless of the shortcomings of each of the cited studies, a coherent picture of the healthy human blood microbiome emerges when considering the positive aspects revealed by each study. For example, the inclusion of microscopy (McLaughlin et al., 2002) and the application of both DNA (Dinakaran et al., 2014; Païssé et al., 2016; Li et al., 2018; Whittle et al., 2018) and RNA analyses to the blood of healthy individuals (Loohuis et al., 2018; Whittle et al., 2018) have been of great benefit. Given the literature reviewed here and the trend towards the inclusion of analytical (positive and negative) controls in studies of the human blood microbiome, we conclude that the idea that a healthy human blood microbiome exists cannot simply be discarded.

For future studies on the human blood microbiome, we recommend comprehensive experimental studies to reduce both contamination and technical errors. For this, researchers should develop protocols for the acquisition (blood collection), processing (use and storage of kits) and generation (sequencing protocols and techniques) of both healthy and diseased blood microbial data.

We urge researchers to investigate this specialized microbiome because it has the potential to facilitate both diagnosis and a better understanding of the onset of numerous diseases. Much of the literature reviewed here deals with snapshots of bacterial communities in the blood, potentially overlooking important changes in the human blood microbiome over time. In addition, the influence of age, geography and socio-economic status on the structure of the healthy human blood microbiome remains unclear.

Regarding the location of microorganisms in the human blood circulatory system, bacteria are thought to either reside within the blood cells or inhabit the plasma portion of the blood. Furthermore, regarding the origin of the healthy human blood microbiome, it is thought that blood-borne microorganisms, especially bacteria, may originate from various body sites and

**4TH INTERNATIONAL LATIN AMERICAN  
CONGRESS ON NATURAL AND APPLIED SCIENCES**

that many of them may be maternal in origin. Samples from the skin, mouth and gut microbiomes should be analyzed at the same time as blood samples to gain insight into the potential origin of these microbes. Finally, microbiome studies based on WMS are undoubtedly crucial to identify possible roles and functions linked to bacteria and other microorganisms in human blood. The growing recognition of the existence of a healthy blood microbiome is stimulating new and diverse avenues of research, some of which may have important clinical relevance.

## REFERENCES

- Alberts, B., Johnson, A., Lewis, J., Raff, M., Roberts, K., and Walter, P. (2002). *Molecular Biology of the Cell, 4th Edn.* New York, NY: Garland Science.
- Amar, J., Lange, C., Payros, G., Garret, C., Chabo, C., Lantieri, O., et al. (2013). Blood microbiota dysbiosis is associated with the onset of cardiovascular events in a large general population: the DESIR study. *PLoS ONE* 8:e54461. doi: 10.1371/journal.pone.0054461
- Azad, M. B., Konya, T., Maughan, H., Guttman, D. S., Field, C. J., Chari, R. S., et al. (2013). Gut microbiota of healthy Canadian infants: profiles by mode of delivery and infant diet at 4 months. *CMAJ* 185, 385–394. doi: 10.1503/cmaj.121189
- Bahrani-Mougeot, F. K., Paster, B. J., Coleman, S., Ashar, J., Barbuto, S., and Lockhart, P. B. (2008). Diverse and novel oral bacterial species in blood following dental procedures. *J. Clin. Microbiol.* 46, 2129–2132. doi: 10.1128/JCM.02004-07
- Biasucci, G., Benenati, B., Morelli, L., Bessi, E., and Boehm, G. (2008). Cesarean delivery may affect the early biodiversity of intestinal bacteria. *J. Nutr.* 138, 1796S–1800S. doi: 10.1093/jn/138.9.1796S
- Blache, D. (1992). Structure and function of blood platelets. *Arch. Int. Physiol. Biochim. Biophys.* 100:A17–24. doi: 10.3109/13813459209000709
- Cho, I., and Blaser, M. J. (2012). The human microbiome: at the interface of health and disease. *Nat. Rev. Genet.* 13:260. doi: 10.1038/nrg3182
- Cogen, A., Nizet, V., and Gallo, R. (2008). Skin microbiota: a source of disease or defence? *Br. J. Dermatol.* 158, 442–455. doi: 10.1111/j.1365-2133.2008.08437.x
- Damgaard, C., Magnussen, K., Enevold, C., Nilsson, M., Tolker-Nielsen, T., Holmstrup, P., et al. (2015). Viable bacteria associated with red blood cells and plasma in freshly drawn blood donations. *PLoS ONE*. 10:e0120826. doi: 10.1371/journal.pone.0120826
- Dinakaran, V., Rathinavel, A., Pushpanathan, M., Sivakumar, R., Gunasekaran, P., and Rajendhran, J. (2014). Elevated levels of circulating DNA in cardiovascular disease patients: metagenomic profiling of microbiome in the circulation. *PLoS ONE*. 9:e105221. doi: 10.1371/journal.pone.0105221
- Dominguez-Bello, M. G., Costello, E. K., Contreras, M., Magris, M., Hidalgo, G., Fierer, N., et al. (2010). Delivery mode shapes the acquisition and structure of the initial microbiota

**4TH INTERNATIONAL LATIN AMERICAN  
CONGRESS ON NATURAL AND APPLIED SCIENCES**

across multiple body habitats in newborns. *Proc. Natl. Acad. Sci. U.S.A.* 107, 11971–11975. doi: 10.1073/pnas.1002601107

Emerson, J. B., Adams, R. I., Román, C. M. B., Brooks, B., Coil, D. A., Dahlhausen, K., et al. (2017). Schrödinger's microbes: tools for distinguishing the living from the dead in microbial ecosystems. *Microbiome* 5:86. doi: 10.1186/s40168-017-0285-3

Forner, L., Larsen, T., Kilian, M., and Holmstrup, P. (2006). Incidence of bacteremia after chewing, tooth brushing and scaling in individuals with periodontal inflammation. *J. Clin. Periodontol.* 33, 401–407. doi: 10.1111/j.1600-051X.2006.00924.x

Furuta, R. A., Sakamoto, H., Kuroishi, A., Yasiui, K., Matsukura, H., and Hirayama, F. (2015). Metagenomic profiling of the viromes of plasma collected from blood donors with elevated serum alanine aminotransferase levels. *Transfusion* 55, 1889–1899. doi: 10.1111/trf.13057

Front. Cell. Infect. Microbiol., 08 May 2019 Sec. Microbiome in Health and Disease Volume 9 - 2019 | <https://doi.org/10.3389/fcimb.2019.00148>

Front. Microbiol., 17 January 2019 Sec. Systems Microbiology Volume 9 - 2018 | <https://doi.org/10.3389/fmicb.2018.03266>

Gosiewski, T., Ludwig-Galezowska, A., Huminska, K., Sroka-Oleksiak, A., Radkowski, P., Salamon, D., et al. (2016). Comprehensive detection and identification of bacterial DNA in the blood of patients with sepsis and healthy volunteers using next-generation sequencing method-the observation of DNAemia. *Eur. J. Clin. Microbiol. Infect. Dis.* 2016, 1–8. doi: 10.1007/s10096-016-2805-7

Gresham, H. D., Lowrance, J. H., Caver, T. E., Wilson, B. S., Cheung, A. L., and Lindberg, F. P. (2000). Survival of *Staphylococcus aureus* inside neutrophils contributes to infection. *J. Immunol.* 164, 3713–3722. doi: 10.4049/jimmunol.164.7.3713

Iwai, T. (2009). Periodontal bacteremia and various vascular diseases. *J. Clin. Periodontol.* 44, 689–694. doi: 10.1111/j.1600-0765.2008.01165.x

Jerne, N. K. (1973). The immune system. *Sci. Am.* 229, 52–63. doi: 10.1038/scientificamerican0773-52

Jiménez, E., Fernández, L., Marín, M. L., Martín, R., Odriozola, J. M., Nuño-Palop, C., et al. (2005). Isolation of commensal bacteria from umbilical cord blood of healthy neonates born by cesarean section. *Curr. Microbiol.* 51, 270–274. doi: 10.1007/s00284-005-0020-3

Khanna, S., and Tosh, P. K. (2014). A clinician's primer on the role of the microbiome in human health and disease. *Mayo. Clin. Proc.* 89, 107–114. doi: 10.1016/j.mayocp.2013.10.011

Kim, B.-S., Jeon, Y.-S., and Chun, J. (2013). Current status and future promise of the human microbiome. *J. Pediatr. Gastroenterol. Nutr.* 16, 71–79. doi: 10.5223/pghn.2013.16.2.71

Kowarsky, M., Camunas-Soler, J., Kertesz, M., De Vlaminck, I., Koh, W., Pan, W., et al. (2017). Numerous uncharacterized and highly divergent microbes which colonize humans are

**4TH INTERNATIONAL LATIN AMERICAN  
CONGRESS ON NATURAL AND APPLIED SCIENCES**

revealed by circulating cell-free DNA. *Proc Natl Acad Sci U S A*. 114, 9623–9628. doi: 10.1073/pnas.1707009114

Lauder, A. P., Roche, A. M., Sherrill-Mix, S., Bailey, A., Laughlin, A. L., Bittinger, K., et al. (2016). Comparison of placenta samples with contamination controls does not provide evidence for a distinct placenta microbiota. *Microbiome* 4:29. doi: 10.1186/s40168-016-0172-3

Lelouvier, B., Servant, F., Païssé, S., Brunet, A. C., Benyahya, S., Serino, M., et al. (2016). Changes in blood microbiota profiles associated with liver fibrosis in obese patients: a pilot analysis. *Hepatology* 64, 2015–2027. doi: 10.1002/hep.28829

Li, Q., Wang, C., Tang, C., Zhao, X., He, Q., and Li, J. (2018). Identification and characterization of blood and neutrophil-associated microbiomes in patients with severe acute pancreatitis using next-generation sequencing. *Front. Cell Infect. Microbiol.* 8:5. doi: 10.3389/fcimb.2018.00005

Lloyd-Price, J., Abu-Ali, G., and Huttenhower, C. (2016). The healthy human microbiome. *Genome Med.* 8:51. doi: 10.1186/s13073-016-0307-y

Loohuis, L. M. O., Mangul, S., Ori, A. P., Jospin, G., Koslicki, D., Yang, H. T., et al. (2018). Transcriptome analysis in whole blood reveals increased microbial diversity in schizophrenia. *Transl. Psychiatry.* 8:96. doi: 10.1038/s41398-018-0107-9

Martel, J., Wu, C.-Y., Huang, P.-R., Cheng, W.-Y., and Young, J. D. (2017). Pleomorphic bacteria-like structures in human blood represent non-living membrane vesicles and protein particles. *Sci. Rep.* 7:10650. doi: 10.1038/s41598-017-10479-8

McLaughlin, R. W., Vali, H., Lau, P. C., Palfree, R. G., De Ciccio, A., Sirois, M., et al. (2002). Are there naturally occurring pleomorphic bacteria in the blood of healthy humans? *J. Clin. Microbiol.* 40, 4771–4775. doi: 10.1128/JCM.40.12.4771-4775.2002

Mitchell, A. J., Gray, W. D., Schroeder, M., Yi, H., Taylor, J. V., Dillard, R. S., et al. (2016). Pleomorphic structures in human blood are red blood cell-derived microparticles, not bacteria. *PLoS ONE* 11:e0163582. doi: 10.1371/journal.pone.0163582

Molina, D. K., and DiMaio, V. J. (2012). Normal organ weights in men: part I-the heart. *Am. J. Forensic Med. Pathol.* 33, 362–367. doi: 10.1097/PAF.0b013e31823d298b

Morgan, X. C., Tickle, T. L., Sokol, H., Gevers, D., Devaney, K. L., Ward, D. V., et al. (2012). Dysfunction of the intestinal microbiome in inflammatory bowel disease and treatment. *Genome Biol.* 13:R79. doi: 10.1186/gb-2012-13-9-r79

Moriyama, K., Ando, C., Tashiro, K., Kuhara, S., Okamura, S., Nakano, S., et al. (2008). Polymerase chain reaction detection of bacterial 16S rRNA gene in human blood. *Microbiol. Immunol.* 52, 375–382. doi: 10.1111/j.1348-0421.2008.00048.x

Moustafa, A., Xie, C., Kirkness, E., Biggs, W., Wong, E., Turpaz, Y., et al. (2017). The blood DNA virome in 8,000 humans. *PLoS Pathog.* 13:e1006292. doi: 10.1371/journal.ppat.1006292

**4TH INTERNATIONAL LATIN AMERICAN  
CONGRESS ON NATURAL AND APPLIED SCIENCES**

Nikkari, S., McLaughlin, I. J., Bi, W., Dodge, D. E., and Relman, D. A. (2001). Does blood of healthy subjects contain bacterial ribosomal DNA? *J. Clin. Microbiol.* 39, 1956–1959. doi: 10.1128/JCM.39.5.1956-1959.2001

Païssé, S., Valle, C., Servant, F., Courtney, M., Burcelin, R., Amar, J., et al. (2016). Comprehensive description of blood microbiome from healthy donors assessed by 16S targeted metagenomic sequencing. *Transfusion* 56, 1138–1147. doi: 10.1111/trf.13477

Panaiotov, S., Filevski, G., Equestre, M., Nikolova, E., and Kalfin, R. (2018). Cultural isolation and characteristics of the blood microbiome of healthy individuals. *Adv. Microbiol.* 8:406. doi: 10.4236/aim.2018.85027

Penders, J., Thijs, C., Vink, C., Stelma, F. F., Snijders, B., Kummeling, I., et al. (2006). Factors influencing the composition of the intestinal microbiota in early infancy. *Pediatrics* 118, 511–521. doi: 10.1542/peds.2005-2824

Potgieter, M., Bester, J., Kell, D. B., and Pretorius, E. (2015). The dormant blood microbiome in chronic, inflammatory diseases. *FEMS Microbiol. Rev.* 39, 567–591. doi: 10.1093/femsre/fuv013

Qiu, J., Zhou, H., Jing, Y., and Dong, C. (2019). Association between blood microbiome and type 2 diabetes mellitus: a nested case-control study. *J. Clin. Lab. Anal.* e22842. doi: 10.1002/jcla.22842

Rascovan, N., Duraisamy, R., and Desnues, C. (2016). Metagenomics and the human virome in asymptomatic individuals. *Annu. Rev. Microbiol.* 70, 125–141. doi: 10.1146/annurev-micro-102215-095431

Salter, S. J., Cox, M. J., Turek, E. M., Calus, S. T., Cookson, W. O., Moffatt, M. F., et al. (2014). Reagent and laboratory contamination can critically impact sequence-based microbiome analyses. *BMC Biol.* 12:87. doi: 10.1186/s12915-014-0087-z

Sato, J., Kanazawa, A., Ikeda, F., Yoshihara, T., Goto, H., Abe, H., et al. (2014). Gut dysbiosis and detection of “live gut bacteria” in blood of Japanese patients with type 2 diabetes. *Diabetes Care.* 37, 2343–2350. doi: 10.2337/dc13-2817

Segata, N., Boernigen, D., Tickle, T. L., Morgan, X. C., Garrett, W. S., and Huttenhower, C. (2013). Computational meta'omics for microbial community studies. *Mol. Syst. Biol.* 9:666. doi: 10.1038/msb.2013.22

Stremlau, M. H., Andersen, K. G., Folarin, O. A., Grove, J. N., Odi, I., Ehiane, P. E., et al. (2015). Discovery of novel rhabdoviruses in the blood of healthy individuals from West Africa. *PLoS Negl. Trop. Dis.* 9:e0003631. doi: 10.1371/journal.pntd.0003631

Tedeschi, G., Amici, D., and Paparelli, M. (1969). Incorporation of nucleosides and amino-acids in human erythrocyte suspensions: possible relation with a diffuse infection of mycoplasmas or bacteria in the L form. *Nature* 222, 1285–1286. doi: 10.1038/2221285a0

**4TH INTERNATIONAL LATIN AMERICAN  
CONGRESS ON NATURAL AND APPLIED SCIENCES**

Traykova, D., Schneider, B., Chojkier, M., and Buck, M. (2017). Blood microbiome quantity and the hyperdynamic circulation in decompensated cirrhotic patients. *PLoS ONE*. 12:e0169310. doi: 10.1371/journal.pone.0169310

Whittle, E., Leonard, M. O., Harrison, R., Gant, T. W., and Tonge, D. P. (2018). Multi-method characterization of the human circulating microbiome. *Front. Microbiol.* 9:3266. doi: 10.3389/fmicb.2018.03266



**4TH INTERNATIONAL LATIN AMERICAN  
CONGRESS ON NATURAL AND APPLIED SCIENCES**

**IN VITRO CULTURE MODELS IN LATENT TUBERCULOSIS INFECTION**

**Cemilenur Ataş**

Akdeniz University Tuberculosis Research Center.

ORCID: 0000-0003-3661-1017

**Majda Ličina**

Akdeniz University Tuberculosis Research Center.

ORCID: 0000-0003-3823-1333

**Kübra Yıldırım**

Phd, Akdeniz University Tuberculosis Research Center.

ORCID: 0000-0003-0558-9619

**Ece Şimsek**

Assoc. Prof. Dr., Akdeniz University Tuberculosis Research Center.

ORCID: 0000-0002-7642-6601

**Ahmet Yılmaz Çoban**

Prof. Dr. Akdeniz University Tuberculosis Research Center.

ORCID: 0000-0002-8815-6063

**ABSTRACT**

Tuberculosis (TB), one of the ancient diseases, infects about 10 million people every year. One out of every four people in the world carries a live TB bacillus in their body but does not show any symptoms of the disease. These individuals represent latent TB infection. Latent TB infection is one of the biggest obstacles to the eradication of the disease. Because individuals with latent TB are the largest reservoir of active TB cases. In individuals infected with TB bacillus, the immune system tries to control the infection by keeping the bacilli in a compact immune system cell cluster, mostly macrophages, called granulomas. If the granuloma cannot be preserved due to the disorders in the immune system, the TB bacillus is released and the infection progresses to active TB disease. It is assumed that the replication of bacilli within the granuloma continues at a low level, metabolic activities are minimally regulated, gene expression changes and there is phenotypic drug tolerance. The environment in granuloma has a different profile, including hypoxia, nutrient deprivation, limited carbon sources, high concentration of nitric oxide, and low pH. It is thought that these environmental conditions are the transition of the bacillus to the dormant phase. It is necessary to elucidate the

mechanisms by which bacilli return to a dormant state and active growth for the control of TB infection. For this reason, several *in vitro* models have been developed that mimic conditions within the granuloma. Wayne's hypoxia model, Loebel's nutrient limitation model, nitric oxide model, and multiple stress model are some of them. All models contribute to the laboratory modeling of latent infection and understanding the mechanism of infection by imitating the stress conditions in the granuloma in a closed tube in a culture medium.

**Keywords:** *Mycobacterium tuberculosis*, latent infection, dormancy models, granulomas

## **INTRODUCTION**

*Mycobacterium tuberculosis* has been one of the deadliest agents of public health from the past to the present. This pathogen, which is the causative agent of tuberculosis (TB), spreads among humans through the respiratory tract and can infect many organs, especially the lungs (Bloom et al, 2010: 234). According to the 2022 report of the World Health Organization (WHO), 10.6 million people in the world were infected with TB bacillus in 2021 and 1.6 million people died due to TB. TB, which ranked 13<sup>th</sup> from the beginning in the worldwide causes of death in 2019, ranks second after COVID-19 in terms of deaths caused by a single infectious agent (WHO, 2022: 2). In the last 3 years, the negative impact of the pandemic on the access to diagnosis and treatment of TB continues. This effect has reversed progress in global TB targets (WHO, 2022: 5). Antimicrobial resistance, which is an important problem of the 21<sup>st</sup> century, makes it more difficult to treat TB.

Antimicrobial resistance due to spontaneous mutations in the genome has significantly limited therapeutic options against TB. TB-HIV co-infection is another current TB challenge. TB and HIV often accelerate each other's progression, and one disease can amplify the other. Therefore, there is a negative bidirectional interaction between these two pathogens (Heidary et al, 2022: 1). A separate infection condition called latent tuberculosis infection (LTBI) has made the greatest contribution to the survival of TB as a successful pathogen. Latent tuberculosis infection (LTBI), which is considered to be the largest reservoir of new active TB cases, is known as the silent form of the disease. This form of infection is one of the biggest obstacles to the eradication of TB (Kiazyk and Ball, 2017: 62).

### **Latent Tuberculosis Infection (LTBI)**

WHO defines LTBI as a sustained immune response to stimulation by *M. tuberculosis* antigens without evidence of clinically manifested active TB (WHO, 2015: 10). LTBI represents approximately 1 in 4 of the world's population. In other words, one out of every 4 people carries a live TB bacillus in their body, but does not show any disease symptoms (WHO, 2022: 1). The ability of the bacillus to enter a latent or Non-Replicating Persistent (NRP) state is the most important virulence factor of TB (Gibson et al. 2018: 7). The terms "Latent" and "Persistence" are often used interchangeably in the literature. The term "persistence" was first used by Bigger in 1944 to denote genetically drug-susceptible organisms in a bacterial population, referring to staphylococcal species that can survive long-term treatment with penicillin (Bigger, 1944: 498). McDermott then defined persistence for *M. tuberculosis* as "the capacity of drug-susceptible organisms to survive drug attack while

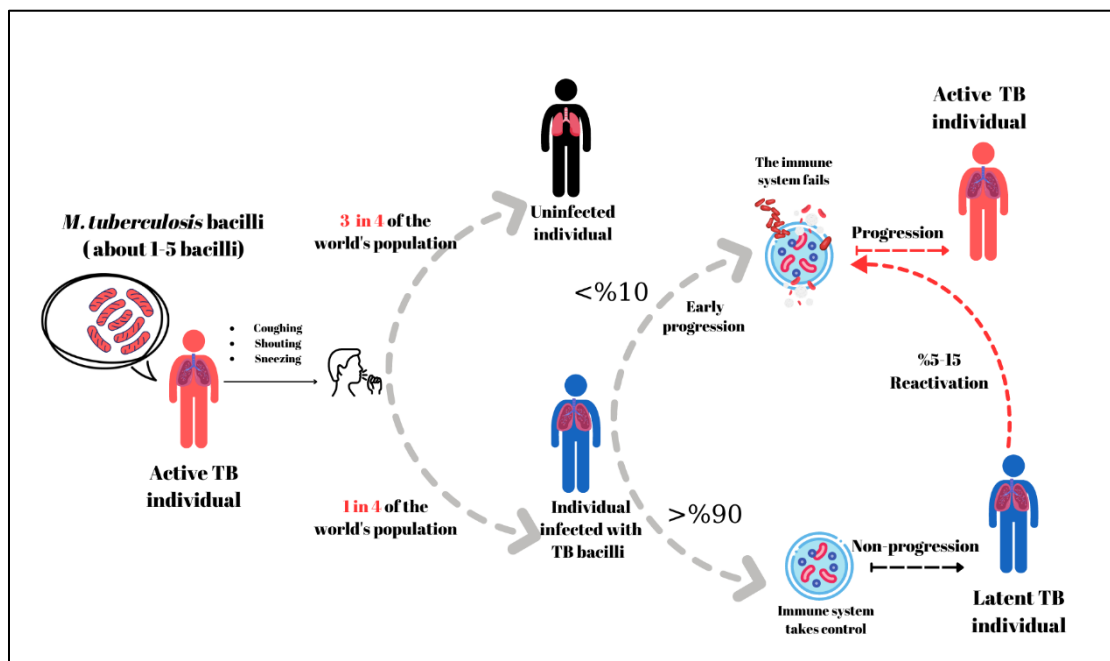
**4TH INTERNATIONAL LATIN AMERICAN  
CONGRESS ON NATURAL AND APPLIED SCIENCES**

living in an animal body” (McDermott, 1958: 258). In short, “Persistence” is associated with the survival of *M. tuberculosis* in host tissues under various stress conditions and mostly with antibiotic pressure. The term “latent” refers to the condition arising from the immune system of the host. Both terms are phenotypically related to each other and reflect similar physiological states of the organism (Dutta and Karakousis, 2014:344). Another expression that is often used together with these concepts is “Dormancy”. Dormancy, which is not a term specific to mycobacteria only, means "to sleep" in Latin and is used to describe many situations in which bacteria can survive but have minimal metabolic activities (Wayne and Hayes, 1996: 2062; Balaban et al. 2004: 1622).

### **Tuberculosis Transmission**

TB bacillus spreads among people with strong respiratory secretions such as coughing, shouting, and sneezing individuals with active TB, and by scattering bacillus-laden aerosols into the air (Churchyard et al. 2017: 637). It is estimated that the infectious dose for *M. tuberculosis* infection to occur is approximately 1-5 bacilli (Balasubramanian et al. 1994: 169). After the ingestion of infectious aerosols by healthy individuals, the bacillus migrates to the lungs and usually is located in phagocytes. As the infection progresses, neutrophils, monocytes, and dendritic cells clump together with distress signals from infected macrophages. These innate immune cells then, together with the adaptive immune system, take control and prevent bacteria from multiplying. The immune system keeps the infection under control by keeping the bacilli in a "compact immune system cell cluster" called a granuloma, mostly composed of macrophages.

In this way, individuals who develop latent immediately after infection instead of active disease constitute 90% of individuals infected with TB bacillus (Sia and Rengarajan, 2019:2; Kumar et al. 2019: 1; Ernst, 2012: 581). Granulomas formed as a result of the immune response to infection exhibit adverse environmental conditions and induce dormancy of bacilli at these sites of infection for years. Since dormancy is a reversible condition, if the granuloma structure is not preserved, TB bacilli may emerge from dormancy, reactivate, and develop into active disease. Reactivation of TB bacillus is more common in immunocompromised individuals. The rate of reactivation in an individual is estimated to be 5-15% during a lifetime (Flynn and Chan, 2001: 4195; Scanga et al. 1999: 4531).



**Figure 1.** The probability of Active TB and Latent TB infection in the community

Both epidemiological data and mathematical models highlight that LTBI is an important issue that needs to be addressed to eradicate TB (Ding et al. 2022: 46).

**General Characteristics of Dormant TB Bacilli**

Generally, dormancy is defined as a reversible state characterized by minimal metabolic activity and replication arrest of bacteria (Kaprelyants et al, 1993: 272). One of the most distinctive features of the dormant phase is the "non-replication" situation. It is generally thought that bacteria cannot reproduce during latent infection, but this assumption may not always be valid. There may be many different bacterial replication states during the latent phase of infection in humans (Behinaein and Cirillo, 2019: 24). It has been proven by studies that the restriction fragment length polymorphism (RFLP) associated with the insertion sequence profiles of latent TB bacilli has not changed for decades and supports the idea of decreased bacterial replication in the latent state (Lillebaek et al. 2003: 1032). Thus, both latent and active TB infections are presumed to consist of a heterogeneous population of mycobacteria with varying proportions. In this heterogeneous population of bacilli, specific gene expressions were observed depending on the stress factors within the granuloma. Among these, the DosR (Dormancy survival regulator) regulation is one of the best-known genes for its role in the formation and maintenance of dormancy. However, complete and precise information about the expression of dormancy genes is not present (Boon and Dick, 2012: 514). It has been reported that there are some changes in the metabolism of TB bacillus with the development of dormancy. The common feature of these changes is the slowing of all basic metabolic activities, resulting in the cessation of cell growth and division. It is known that dormant bacilli synthesize proteins that they do not express while active, activate the glyoxylate shunt, decrease the intracellular ATP level, and change the lipid metabolism of the cell wall (Batyrschina and Schwartz, 2019: 8). It appears that TB bacilli become phenotypically insensitive to drugs as they enter dormancy. Drugs encounter a lack of target with the minimization of metabolic activities. As a result of this situation, phenotypic drug tolerance occurs. The phenotypic drug tolerance of the best isoniazid among the anti-TB drugs was investigated. Studies on the tolerance of other drugs are inconsistent (Kester and Fortune, 2014: 92; Tudo et al. 2010: 1372).

***In Vitro* Culture Models in LTBI**

The ability of TB bacilli to enter the latent stage is the most important virulence factor. Understanding the nature of latent infection will open up ways to eradicate TB. Unfortunately,

knowledge about latent infection is still limited. Scientists cannot simulate LTBI in the laboratory because there is not enough research and researchers cannot understand the nature of the infection because they cannot simulate it. This seems like a paradox. It is a known fact that granuloma formation in TB infection is the response of the host immune system and LTBI is very closely related to granulomas and is the focal point of the infection itself. The host's immune system tries to keep the infection under control with these special formations called granulomas. In granuloma structures, dormancy is tried to be induced by several environmental stress factors that the bacillus does not encounter in the normal life cycle, and if it does, it will adversely affect its reproduction. The most well-known of these stress factors are hypoxia, low pH, nutrient deprivation, and high NO concentration, which are quite challenging for an aerobic bacterium. Apart from these, it has been shown by some models that the lack of iron, magnesium, potassium ions, excess copper ions, the presence of ascorbic acid, and the presence of some antibacterials create stress for the TB bacillus and induce dormancy.

### **The Wayne Hypoxia Model**

This model, proposed by Wayne in 1996, is the most widely used by researchers to model dormant TB bacilli. It is aimed to induce dormancy by gradual depletion of oxygen concentration in a culture medium. Low oxygen concentration is a negative parameter for TB bacilli, which are obligate aerobics, and they pass the bacilli to the dormant stage over time. Since it is known that the sudden transfer of strongly aerated TB cultures to anaerobic conditions results in rapid death, the available O<sub>2</sub> is gradually consumed so that bacilli become tolerant to anaerobiosis (Wayne and Hayes, 1996: 2062).

The bacilli pass to the dormant stage in 2 stages:

**Microaerophilic stage:** This stage begins when the oxygen saturation in the environment reaches 1%. A slowdown in nucleic acid replication, an increase in ATP content, and an increase in nitrate reductase activity are observed. It contributes to the adaptation to anaerobic conditions.

**Anaerobic stage:** This stage begins when the oxygen saturation drops below 0.06%. Replication stops and a sharp decrease in glycine dehydrogenase synthesis is observed. According to this model, dormant bacilli are resistant to the bactericidal action of rifampicin and isoniazid, but sensitive to the anaerobic bactericidal action of metronidazole, which does not affect aerobic cultures of *M. tuberculosis* (Wayne and Sramek, 1994: 2054).

### **Nutrient Deprivation Model**

*M. tuberculosis* trapped in the granuloma has problems supplying the nutrients necessary for its vital activities. Several models have been developed that simulate the starvation of the TB bacillus. According to studies conducted in recent years, it is known that they are not only deprived of food but are limited to single-chain fatty acids, that is, cholesterol as the sole carbon source (Betts et al. 2002: 718). In 1933, Loebel et al. showed that TB bacillus can

## 4TH INTERNATIONAL LATIN AMERICAN CONGRESS ON NATURAL AND APPLIED SCIENCES

survive in the dormant phase for long periods even if transferred to PBS in a rich medium. In this case, it was observed that the bacilli remained in the early stationary phase with a slowdown in respiratory rate. According to this model, the idea has emerged that bacilli reduce their oxygen consumption and survive on pre-stored foodstuffs. Future studies also supported this idea (Loebel et al. 1933: 168).

### Multiple Stress Model

It is a successful *in vitro* model that simultaneously uses four different environmental stress factors that induce dormancy in *M. tuberculosis*. These environmental stress factors are low oxygen content (5%), high CO<sub>2</sub> concentration (10%), low pH (pH:5), and nutrient starvation (10% Dubos medium). According to this model, TB bacilli enter the dormant phase in 18 days (Deb et al. 2009: 6077). Expression of energy metabolism-related genes, especially genes encoding ATP synthase and NADH dehydrogenase, is suppressed. Researchers think that this model better reflects *in vivo* dormancy of TB bacilli than models that use only one of the potential dormancy triggers (Campaniço et al. 2020: 5).

### Conclusion

The ability to cause latent infection is an important virulence factor of TB. The mechanisms that induce and maintain the persistence of a pathogen in LTBI are still unclear. Several *in vitro* models have been developed that mimic conditions within the granuloma. Each of these models contributes to different approaches and purposes. During the formation of a novel dormancy model for bacterial infection, the model should represent the *in vivo* situation. As the models above show, different environments all induce a distinctly different state of dormancy, with different genetic profiles and drug susceptibility. More *in vitro* modeling studies are needed to represent the clinical situation.

### REFERENCES

- Balaban, N. Q., Merrin, J., Chait, R., Kowalik, L., & Leibler, S. (2004). Bacterial persistence as a phenotypic switch. *Science (New York, N.Y.)*, 305(5690), 1622–1625. <https://doi.org/10.1126/science.1099390>
- Balasubramanian, V., Wiegeshaus, E. H., Taylor, B. T., & Smith, D. W. (1994). Pathogenesis of tuberculosis: pathway to apical localization. *Tubercle and lung disease* :



**4TH INTERNATIONAL LATIN AMERICAN  
CONGRESS ON NATURAL AND APPLIED SCIENCES**

*the official journal of the International Union against Tuberculosis and Lung Disease*, 75(3), 168–178. [https://doi.org/10.1016/0962-8479\(94\)90002-7](https://doi.org/10.1016/0962-8479(94)90002-7)

Batyrshina, Y. R., & Schwartz, Y. S. (2019). Modeling of Mycobacterium tuberculosis dormancy in bacterial cultures. *Tuberculosis (Edinburgh, Scotland)*, 117, 7–17. <https://doi.org/10.1016/j.tube.2019.05.005>

Behinaein, P., Cirillo, J.D. (2019). The Silent Plague: Regulation of Latent Tuberculosis Infections. In: Cirillo, J., Kong, Y. (eds) *Tuberculosis Host-Pathogen Interactions*. Springer, Cham. [https://doi.org/10.1007/978-3-030-25381-3\\_2](https://doi.org/10.1007/978-3-030-25381-3_2)

Betts, J. C., Lukey, P. T., Robb, L. C., McAdam, R. A., & Duncan, K. (2002). Evaluation of a nutrient starvation model of Mycobacterium tuberculosis persistence by gene and protein expression profiling. *Molecular microbiology*, 43(3), 717–731. <https://doi.org/10.1046/j.1365-2958.2002.02779.x>

Bigger, J.W. (1944). treatment of staphylococcal infections with penicillin by intermittent sterilisation. *The Lancet*, 244, 497-500.

Bloom, BR. and Atun R. (2010). *Major infectious diseases*. Washington, DC

Boon, C., & Dick, T. (2012). How Mycobacterium tuberculosis goes to sleep: the dormancy survival regulator DosR a decade later. *Future microbiology*, 7(4), 513–518. <https://doi.org/10.2217/fmb.12.14>

Campaniço, A., Harjivan, S. G., Warner, D. F., Moreira, R., & Lopes, F. (2020). Addressing Latent Tuberculosis: New Advances in Mimicking the Disease, Discovering Key Targets, and Designing Hit Compounds. *International journal of molecular sciences*, 21(22), 8854. <https://doi.org/10.3390/ijms21228854>

Churchyard, G., Kim, P., Shah, N. S., Rustomjee, R., Gandhi, N., Mathema, B., Dowdy, D., Kasmar, A., & Cardenas, V. (2017). What We Know About Tuberculosis Transmission: An Overview. *The Journal of infectious diseases*, 216(suppl\_6), S629–S635. <https://doi.org/10.1093/infdis/jix362>

Deb, C., Lee, C. M., Dubey, V. S., Daniel, J., Abomoelak, B., Sirakova, T. D., Pawar, S., Rogers, L., & Kolattukudy, P. E. (2009). A novel in vitro multiple-stress dormancy model for Mycobacterium tuberculosis generates a lipid-loaded, drug-tolerant, dormant pathogen. *PloS one*, 4(6), e6077. <https://doi.org/10.1371/journal.pone.0006077>

Ding, C., Hu, M., Guo, W., Hu, W., Li, X., Wang, S., Shangguan, Y., Zhang, Y., Yang, S., & Xu, K. (2022). Prevalence trends of latent tuberculosis infection at the global, regional, and country levels from 1990-2019. *International journal of infectious diseases: IJID: official publication of the International Society for Infectious Diseases*, 122, 46–62. <https://doi.org/10.1016/j.ijid.2022.05.029>

**4TH INTERNATIONAL LATIN AMERICAN  
CONGRESS ON NATURAL AND APPLIED SCIENCES**

- Dutta, N. K., & Karakousis, P. C. (2014). Latent tuberculosis infection: myths, models, and molecular mechanisms. *Microbiology and molecular biology reviews* : *MMBR*, 78(3), 343–371. <https://doi.org/10.1128/MMBR.00010-14>
- Ernst J. D. (2012). The immunological life cycle of tuberculosis. *Nature reviews. Immunology*, 12(8), 581–591. <https://doi.org/10.1038/nri3259>
- Flynn, J. L., & Chan, J. (2001). Tuberculosis: latency and reactivation. *Infection and immunity*, 69(7), 4195–4201. <https://doi.org/10.1128/IAI.69.7.4195-4201.2001>
- Gibson, S. E. R., Harrison, J., & Cox, J. A. G. (2018). Modelling a Silent Epidemic: A Review of the In Vitro Models of Latent Tuberculosis. *Pathogens (Basel, Switzerland)*, 7(4), 88. <https://doi.org/10.3390/pathogens7040088>
- Heidary, M., Shirani, M., Moradi, M., Goudarzi, M., Pouriran, R., Rezaeian, T., & Khoshnood, S. (2022). Tuberculosis challenges: Resistance, co-infection, diagnosis, and treatment. *European journal of microbiology & immunology*, 12(1), 1–17. Advance online publication. <https://doi.org/10.1556/1886.2021.00021>
- Kaprelyants, A. S., Gottschal, J. C., & Kell, D. B. (1993). Dormancy in non-sporulating bacteria. *FEMS microbiology reviews*, 10(3-4), 271–285. <https://doi.org/10.1111/j.1574-6968.1993.tb05871.x>
- Kester, J. C., & Fortune, S. M. (2014). Persisters and beyond: mechanisms of phenotypic drug resistance and drug tolerance in bacteria. *Critical reviews in biochemistry and molecular biology*, 49(2), 91–101. <https://doi.org/10.3109/10409238.2013.869543>
- Kiazyk, S., & Ball, T. B. (2017). Latent tuberculosis infection: An overview. *Canada communicable disease report = Relevé des maladies transmissibles au Canada*, 43(3-4), 62–66. <https://doi.org/10.14745/ccdr.v43i34a01>
- Kumar, R., Singh, P., Kolloli, A., Shi, L., Bushkin, Y., Tyagi, S., & Subbian, S. (2019). Immunometabolism of Phagocytes During *Mycobacterium tuberculosis* Infection. *Frontiers in molecular biosciences*, 6, 105. <https://doi.org/10.3389/fmolb.2019.00105>
- Lillebaek, T., Dirksen, A., Vynnycky, E., Baess, I., Thomsen, V. Ø., & Andersen, A. B. (2003). Stability of DNA patterns and evidence of *Mycobacterium tuberculosis* reactivation occurring decades after the initial infection. *The Journal of infectious diseases*, 188(7), 1032–1039. <https://doi.org/10.1086/378240>
- Loebel, R. O., Shorr, E., & Richardson, H. B. (1933). The Influence of Adverse Conditions upon the Respiratory Metabolism and Growth of Human Tubercle Bacilli. *Journal of bacteriology*, 26(2), 167–200. <https://doi.org/10.1128/jb.26.2.167-200.1933>
- McDermott W. (1958). Microbial persistence. *The Yale journal of biology and medicine*, 30(4), 257–291.

**4TH INTERNATIONAL LATIN AMERICAN  
CONGRESS ON NATURAL AND APPLIED SCIENCES**

Scanga, C. A., Mohan, V. P., Joseph, H., Yu, K., Chan, J., & Flynn, J. L. (1999). Reactivation of latent tuberculosis: variations on the Cornell murine model. *Infection and immunity*, 67(9), 4531–4538. <https://doi.org/10.1128/IAI.67.9.4531-4538.1999>

Sia, J. K., & Rengarajan, J. (2019). Immunology of *Mycobacterium tuberculosis* Infections. *Microbiology spectrum*, 7(4), 10.1128/microbiolspec.GPP3-0022-2018. <https://doi.org/10.1128/microbiolspec.GPP3-0022-2018>

Tudó, G., Laing, K., Mitchison, D. A., Butcher, P. D., & Waddell, S. J. (2010). Examining the basis of isoniazid tolerance in nonreplicating *Mycobacterium tuberculosis* using transcriptional profiling. *Future medicinal chemistry*, 2(8), 1371–1383. <https://doi.org/10.4155/fmc.10.219>

Wayne, L. G., & Hayes, L. G. (1996). An in vitro model for sequential study of shutdown of *Mycobacterium tuberculosis* through two stages of nonreplicating persistence. *Infection and immunity*, 64(6), 2062–2069. <https://doi.org/10.1128/iai.64.6.2062-2069.1996>

Wayne, L. G., & Sramek, H. A. (1994). Metronidazole is bactericidal to dormant cells of *Mycobacterium tuberculosis*. *Antimicrobial agents and chemotherapy*, 38(9), 2054–2058. <https://doi.org/10.1128/AAC.38.9.2054>

World Health Organization. Global Tuberculosis Report 2022

World Health Organization. Guidelines on the management of latent tuberculosis infection. Geneva: WHO; 2015. Available from: <http://www.who.int/tb/publications/latent-tuberculosis-infection/en/>.

**INVESTIGATION OF THE USABILITY OF THE HIGHWAY SURFACE  
DRAINAGE SYSTEM AS A PRECIPITATION WATER HARVESTING SYSTEM**

**KARAYOLLARI YÜZEY DRENAJ SİSTEMİNİN YAĞIŞ SUYU TOPLAMA SİSTEMİ  
OLARAK KULLANILABİLİRLİĞİNİN İNCELENMESİ**

**Seyfi ŞEVİK**

Assoc. Prof. Dr., Hitit University

ORCID ID: 0000-0003-4063-0456

**ABSTRACT**

Highways are travelable roadways that are utilized by modern cultures to preserve their way of life. They are used for transportation inside and between cities. Rainfall coming to the roof is collected by rainwater collection systems to be used as irrigation or drinking water. Systems for managing rainwater are frequently used to protect the security of roadways. Accordingly, systems that serve two related but distinct goals can be merged. In this context, this study is a preliminary study on the usability and conversion potential of the highway precipitation drainage system as a snow water and rainwater harvesting system. For this, a study area has been determined. The length of the surface precipitation drainage channels of the asphalt road is 2000 m (left side) and 2900 m (right side), and the total length is 4900 m. In addition, there are anti-erosion stone walls. The total amount of equivalent snow water that comes with snow for the period between January 26 and February 2, 2023, has been calculated as 377300 m<sup>3</sup>. On February 2, 14635 m<sup>3</sup> of snow water was harvested. In addition, it can be said that the water quality is fairly excellent since a water quality of less than 50 ppm is achieved. It has been observed that the studied region has a serious potential for a rainwater harvest however, the drainage system needs to be rearranged due to structural defects and water leaks in the current situation. Asphalt roads, which are only used for transportation, may be used to meet energy and water needs, save resources in a way that will meet the needs of future generations, and create products utilizing diverse processes to add value.

**Keywords:** Highway surface drainage system, rainwater harvesting, usability, sustainability.

## **ÖZET**

Otoyollar, modern kültürler tarafından yaşam tarzlarını korumak için kullanılan seyahat edilebilir yollardır. Onlar, şehir içi ve şehirlerarası ulaşım için kullanılırlar. Çatıya gelen yağış, sulama veya içme suyu olarak kullanılmak üzere yağmur suyu toplama sistemleri tarafından toplanır. Yağmur suyunu yönetmeye yönelik sistemler, yolların güvenliğini korumak için sıklıkla kullanılmaktadır. Buna göre, birbiriyle ilişkili ancak farklı iki amaca hizmet eden sistemler birleştirilebilir. Bu bağlamda bu çalışma, karayolu yağış drenaj sisteminin kar suyu ve yağmur suyu toplama sistemi olarak kullanılabilirliği ve dönüşüm potansiyeli üzerine bir ön çalışmadır. Bunun için bir çalışma alanı belirlenmiştir. Asfalt yolun yüzey yağış drenaj kanallarının uzunluğu 2000 m (sol taraf) ve 2900 m (sağ taraf) olup, toplam uzunluk 4900 m'dir. Ayrıca, erozyon önleyici taş duvarlar mevcuttur. 26 Ocak – 2 Şubat 2023 tarihleri arasında karla birlikte gelen toplam eşdeğer kar suyu miktarı  $377300 \text{ m}^3$  olarak hesaplanmıştır. 2 Şubat 2023 tarihinde  $14635 \text{ m}^3$  kar suyu hasadı yapılmıştır. Ayrıca, 50 ppm'in altında bir su kalitesi elde edildiğinden su kalitesinin oldukça iyi olduğu söylenebilir. İncelenen bölgenin yağmur suyu hasadı için ciddi bir potansiyele sahip olduğu görülmüştür ancak mevcut durumdaki yapısal bozukluklar ve su kaçakları nedeniyle drenaj sisteminin yeniden düzenlenmesi gerekmektedir. Sadece ulaşım için kullanılan asfalt yollar, enerji ve su ihtiyacını karşılamak, gelecek nesillerin ihtiyaçlarını karşılayacak şekilde kaynak tasarrufu sağlamak ve farklı süreçler kullanılarak değer katan ürünler oluşturmak için kullanılabilir.

**Anahtar Kelimeler:** Karayolu yüzey drenaj sistemi, yağmur suyu hasadı, kullanılabilirlik, sürdürülebilirlik.

## **Nomenclature**

$A_{road,channel}$	rainwater collection area, $\text{m}^2$
$C_r$	runoff (loss) coefficient
$RWH$	yearly amount of harvestable rainwater from the road and channel, $\text{m}^3$
$RW_{tot}$	total annual rainfall, m
$T_{iw}$	total amount of incoming water, $\text{m}^3$
$T_{cw}$	total amount of collecting water, $\text{m}^3$

## **1. Introduction**

Highways are roads that are used for transportation in and between cities and can be traveled, which today's societies use to maintain their lives. Asphalt roads, which are only utilized for transportation, may be utilized to fulfill energy demands, conserve them in a way that will satisfy future generations' needs, and create energy using various means to add more value. With these ideas in mind, the idea of using energy for energy generation without endangering the design of roadways but with new industrial equipment has emerged. On the other hand, innovative ideas for asphalt roads are being developed. These can be categorized as road concepts, along with the production of hot water and air, electricity generation (using piezoelectric generators, PV panels, thermoelectric modules, pyroelectric), energy storage (using phase-changing material-PCM, aquifer thermal energy storage, batteries), and self-heating using frost and icing prevention systems (Şevik, 2016; Şevik, 2021).

Precipitation is any kind of vapor condensation in atmospheric water clouds that rises to the earth's surface because of the clouds' gravitational attraction. Rain, sleet, snow, ice pellets, graupel, drizzle, and hail are the main forms of precipitation. The topic may be divided into two categories: drainage systems and rainwater collection systems. Water and poor drainage on the road surface reduce the strength of the pavement and sub-base, causing premature asphalt road distress, which leads to driving problems and road structural failures. Inadequate drainage causes problems such as traffic safety (aquaplaning and icing), and low bearing capacity in sub-floor and road structures that cause erosion and permanent deformation. Therefore, drainage systems need to be well-organized. Such situations can cause accidents, disrupt traffic flow, and interrupt normal life. In addition, drainage systems need to be well-organized or require good maintenance. The service life of the pavement can be enhanced by 50% if the water is immediately removed from the asphalt road (Rokade et al., 2012). Thus, to guarantee the structural integrity of the flexible pavements, an efficient drainage system should also be built for the drainage of precipitation water during road building. On the other hand, as in a study conducted by Kayhanian et al. (2019) and stated to have an important role in stormwater flow management, it is also possible to apply permeable pavement on highways. Surface concrete drainage systems are typically selected because they are inexpensive, simple to build, and maintain. As opposed to level terrain, sloping land allows for much easier water evacuation using the surface concrete drainage system since it has the necessary bearing capacity to evacuate the flow.

Rainwater collection systems are generally applied to roofs to collect water from roofs, thus



saving water by using them in toilets, gardens, etc. According to Ghisi et al. (2009), using rainwater at gas stations can result in potable water savings of up to 33% and water savings of up to 57%. Kaya (2020) evaluated the rainwater potential of the roofs of the buildings in the Izmit district, Turkey, and calculated the rainwater utilization rate for 2017 as 33.27%. On the other hand, there are systems where rainwater is collected over PV panel arrays in solar PV power plants (Aktaş et al., 2021; Şevik and Aktaş, 2022). Şevik and Aktaş, (2022) established a system consisting of rainwater collection channels, pump-hydrophore installation, and tanks with a capacity of 25 m<sup>3</sup> in the facility area for rainwater harvesting in the PV plant. They also installed a drip irrigation system for an orchard that is located higher than the PV plant. They reported that the potential for collecting rainwater from a small portion (288 m<sup>2</sup>) of the PV power plant is approximately 118 m<sup>3</sup>/year. In addition, they stated that the harvesting system would reach 1646 m<sup>3</sup>/year when applied to the entire PV power plant.

Drainage and rainwater harvesting systems can be used together to both manage water and recycle water for use in agriculture. The objectives of this research are to a) evaluate the current state of the drainage network in the existing highway, b) assess the system's capacity to serve its purposes, c) identify the drainage system's water harvesting potential, d) determine whether the drainage system can be converted to a precipitation harvesting system, and e) evaluate the water collection capacity when used as a precipitation harvesting system.

## **2. Material and Method**

### *2.1. Multiple Use Opportunities of Highways*

Even though there is now a limited quantity of energy produced on highways, studies are being done to satisfy these demands and increase the value of highways, which is currently only utilized for travel and freight movement. However, for a variety of reasons, some of these studies are unable to get past the concept, proposal, and idea stages. The following is a list of some of the techniques utilized or aimed at for energy production on highways (Şevik, 2021).

- a) Electricity generation with wind turbines
  - Electric power generation with conventional wind turbines
  - Electricity generation with modified wind turbines
- b) Electric energy production with biomass
- c) Electricity generation by waves and tides
- d) Electric power generation with mixed biofuels
- e) Renewable energy-assisted electric vehicle charging stations

**4TH INTERNATIONAL LATIN AMERICAN  
CONGRESS ON NATURAL AND APPLIED SCIENCES**

- f) Renewable energy-assisted vehicle hydrogen charging stations
- g) Generating a small amount of electrical energy using the thermoelectric effect
- h) Generating a small amount of electrical energy by vibration capture technology
- i) Generating a small amount of electrical energy using the piezoelectric effect.
- j) Heat and electrical energy production with solar energy
  - Electric power generation with PV panels for warning signs and street lighting
  - Generation of electrical energy with solar noise-canceling barriers
  - Electricity generation with solar-powered road panel
  - Heat energy generation with asphalt road solar collector

Some systems collect roof-borne rainwater for use as a utility or drinking water. In addition, rainwater management systems, which are often employed to maintain the safety of highways, are also utilized. Therefore, similar systems serving two different purposes can be combined. Thus, a win-win situation occurs and sustainable water management can be realized.

### *2.2. Current working area*

The size of the drain depends on a variety of factors, including the frequency and amount of rainfall, the width and profile of the highway, the porosity of the backfill, and the hydraulic conductivity of the subgrade soil (Ozioma, 2022). The computation of the drainage system for water discharge is not present in this analysis, though, as it only examines the current roadway and drainage system. A double asphalt road with a length of 3350 m has just been constructed on sloping terrain. The double asphalt road passing through the studied area is slightly curved and the level difference is 135 m. While the starting altitude of the road is 971 m, the ending altitude is 1106 m. The study location is located in an area with 422.7 mm of annual precipitation.

In this study, highway, and roadway are defined as follows;

Highway=2\*Roadway, and Roadway= Margin+Shoulder+carriage way+Shoulder+Margin

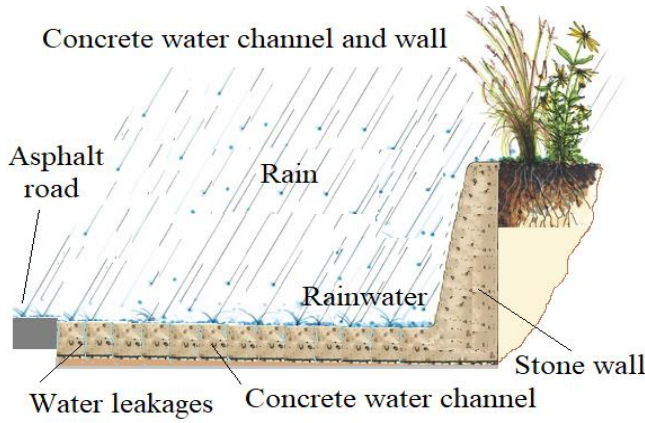
### *2.3. Existing surface concrete precipitation drainage system*

It has open-concept concrete precipitation drainage channels on both sides of the existing double road and in the middle of the roundtrip roads. Although the length of the double asphalt road passing through the studied area is 3350 m, the water channels were not built integrally on both sides of the road. Surface precipitation drainage channels and erosion prevention barriers with a total length of 2000 m are located on the left side of the asphalt road. On the right side of the asphalt road, there is a similar structure with a total length of

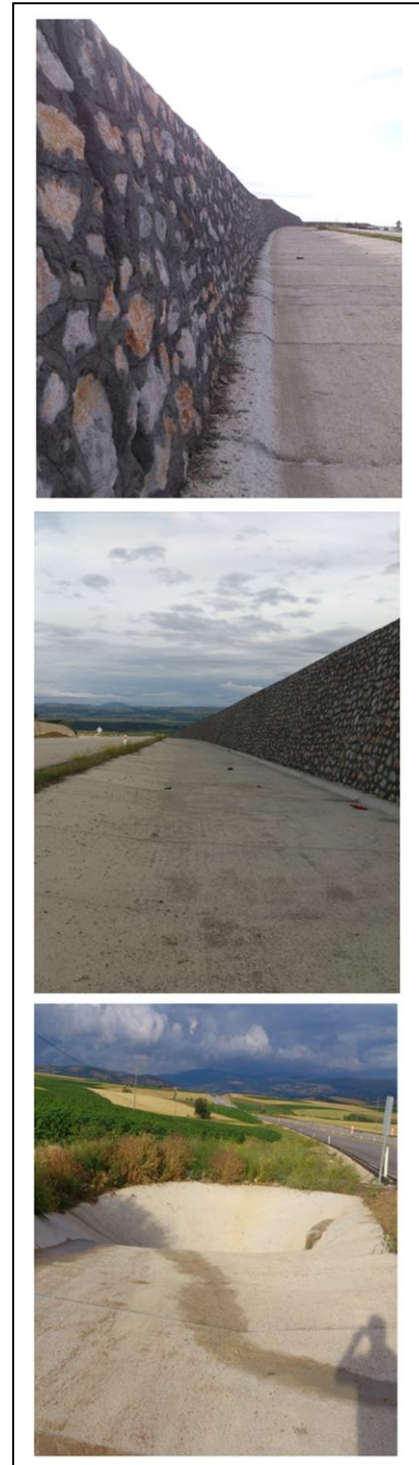
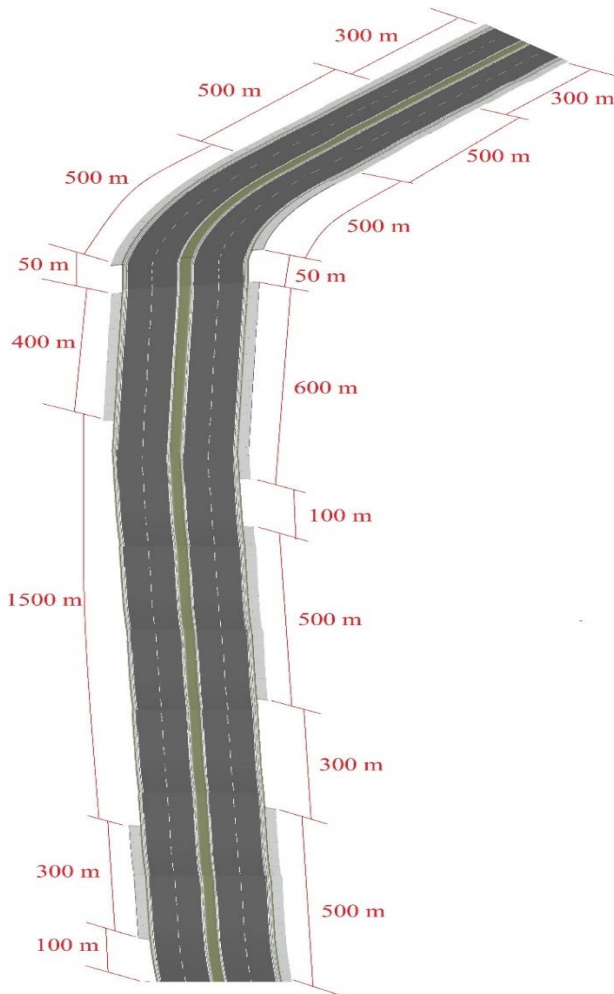
**4TH INTERNATIONAL LATIN AMERICAN  
CONGRESS ON NATURAL AND APPLIED SCIENCES**

2900 m. In general, the surface concrete discharge system can be inclined, V-shaped, U-shaped, trapezoidal, rectangular, or square, and the channels can be lined with mass concrete or reinforced concrete. In the current location, a “V”-shaped concrete structure, divides the roundtrip roads. On the right and left of the double asphalt road, there are surface concrete discharge channels of certain lengths and intermittently organized. Fig. 1 shows the double asphalt road precipitation drainage system. Fig 1a shows the section drawing of the water channel and wall. Fig 1b shows the photos of the concrete channel drainage system and the entire workspace.

According to Fig. 1, on the left side of the asphalt road, there are surface precipitation drainage channels and erosion prevention walls, consisting of five parts and a total length of 2000 m. To the right side of the asphalt road, there are surface precipitation drainage channels and erosion prevention walls, consisting of six parts and a total length of 2900 m. Accordingly, the entire length of the drainage line is approximately 4900 m. The section of approximately 2\*250 m has a slight slope. Other sections have a pretty slope. The anti-erosion stonewalls have a slope of 8%, and the channels have an inclination of 6% in the direction of the stone wall.



a) Section drawing of water channel and wall



b) Photos of the concrete water channel drainage system and the entire workspace

Fig. 1. Double asphalt road precipitation drainage system

The precipitation intensity ( $PI$ ) of the area is measured by measurement equipment. Weather data are obtained from weather studies of the nearest meteorological station.

$$PI = PD/t \quad (1)$$

where  $PD$  is precipitation depth in mm,  $t$  is precipitation duration in min.

The inflow volume ( $V_i$ ) of the water entering the channel is

$$V_i = l_o \cdot PI \cdot A \quad (2)$$

$l_o$  is the coefficient representing water losses.

The outflow volume ( $V_o$ ) of the water entering the channel is

$$V_o = l_e \cdot V_i \quad (3)$$

$l_e$  is coefficient representing water leakages.

The annual amount of rainwater that can be harvested can be estimated from meteorological information. The volume of daily rainwater harvesting is calculated from the daily rainfall amount by multiplying the area with the rainfall amount and deducting the water losses.

The yearly amount of harvestable rainwater (RWH) from road and channels can be calculated as follow;

$$RWH = RW_{tot} A_{road,channel} C_r \quad (4)$$

### **3. Result and discussion**

In the province where the work area is located, the annual precipitation amount, which has been measured and determined for many years, is approximately 422.7 mm. The highest monthly rainfall was in May (62.2 mm), and the lowest was in August (15.2 mm). Fig. 3 shows the meteorological data between January 26 and February 2, 2023. Snowfall amounts were 3.1 mm on 29 January 2023, 1 mm on 31 January, and 8.8 mm on 1 February.

Snow water harvesting was carried out on the day after a snowfall. Fig. 4 shows the snow water harvesting on February 2, 2023. While there was more snow in the shaded areas, there was less snow in the sun-exposed areas. Photos without snow were taken in the afternoon. A conversion from snow to snow water is made to calculate the water coming into the drainage system being studied. This may be called the equivalent snow water or snow-to-rain conversion. The formula used for snow-to-rain conversion is as follows

$$\text{Rainfall [mm]} = \text{snow depth [mm]} * \text{rain-to-snow ratio} \quad (5)$$



**4TH INTERNATIONAL LATIN AMERICAN  
CONGRESS ON NATURAL AND APPLIED SCIENCES**

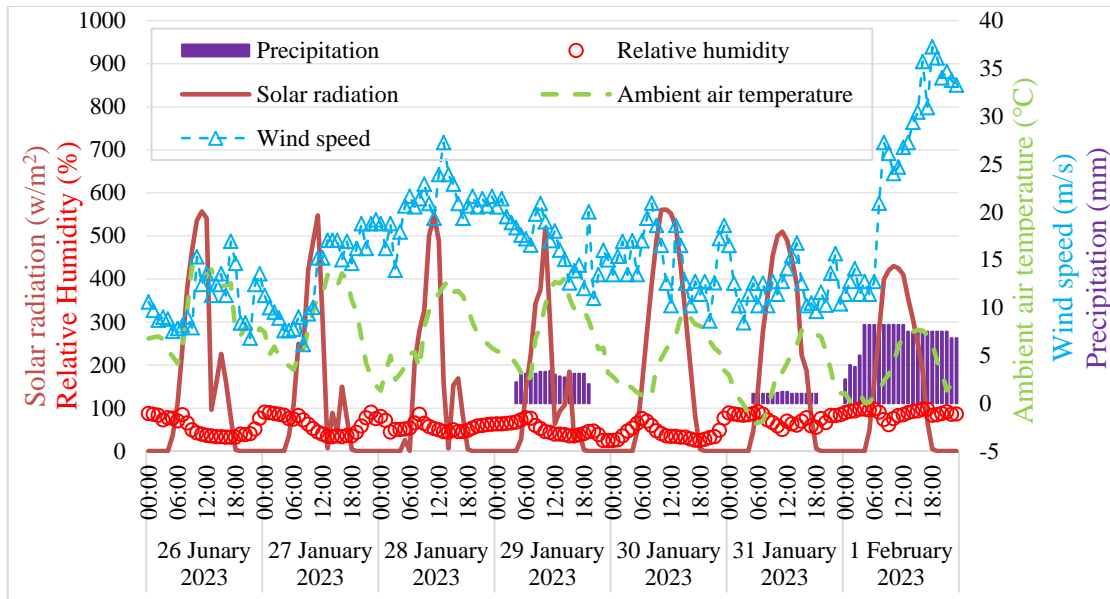


Fig. 3. The meteorological data between January 26 and February 1, 2023.



Fig. 4. Snow water harvesting on February 2, 2023

Fig. 5 shows the total amount of water in terms of snow water coming into the drainage system studied. It also shows the amount of water collected from that drainage system. In



**4TH INTERNATIONAL LATIN AMERICAN  
CONGRESS ON NATURAL AND APPLIED SCIENCES**

other words, Fig. 5 shows the total amount of water collected ( $m^3$ ) and the total amount of incoming water ( $m^3$ ). The total amount of incoming equivalent snow water has been calculated as  $377300 m^3$ . The amount of equivalent snow water obtained from the melting snow on February 2, 2023, is  $14635 m^3$ . There has collected very little water in comparison to the amount of snow. Even so, it is possible to gather the majority of the accumulated snow.

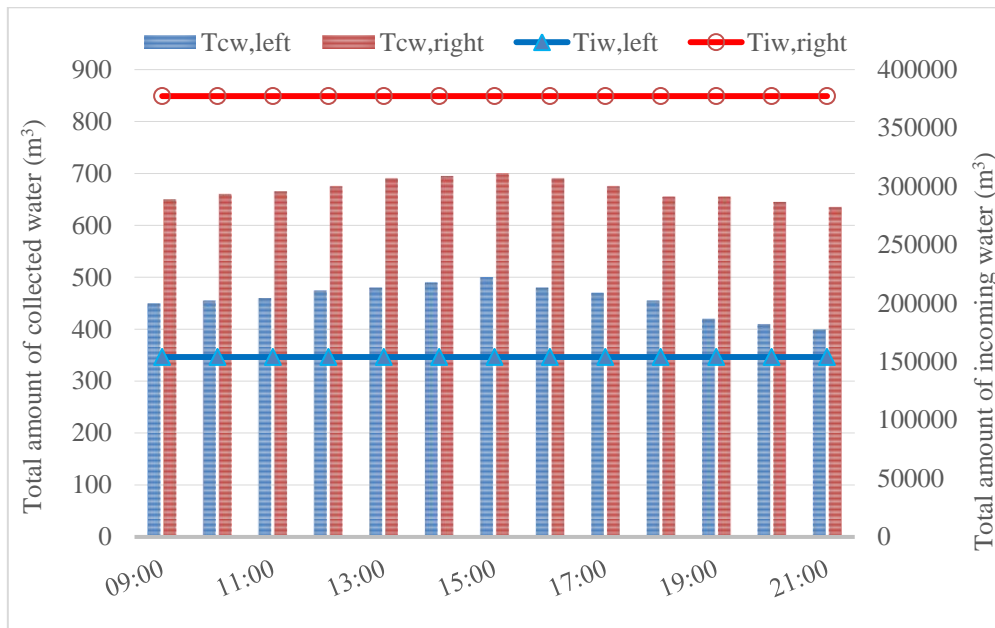


Fig. 5. The amount of water harvested from the workspace, February 2, 2023 (Tiw: the total amount of incoming water, and Tcw: the total amount of collecting water)

With the snowfall on 6-7 February, the capacity to harvest water roughly doubled, but a small amount of water could be collected owing to the negative ambient air temperatures. The snowstorm on February 6-7 caused a significant amount of snow to accumulate on the water channel and anti-erosion walls, as shown in Fig. 6. In addition, the snow shoveled over the road by the snowplow vehicles was also carried to the channels. This indicates an increase in snow that will turn into water, and thus more water can be collected.

Water quality measurements were conducted when the air temperature rose and the snow melted. Fig. 7 shows the water quality measurements. The water quality was assessed using a TDS meter (range: 0-9990 ppm, accuracy:  $\pm 2\%$ , measures from 0-999 ppm, with a resolution of 1 ppm). The water quality values between 18 and 39 ppm were measured based on the measurements made at various locations. While low readings were made near snow accumulations, greater readings were recorded towards the channel's terminus. While the tap water in the study area had a value of 369 ppm, the value in its pool was calculated at 384

**4TH INTERNATIONAL LATIN AMERICAN  
CONGRESS ON NATURAL AND APPLIED SCIENCES**

ppm. Hence, because the water quality is below 50 ppm, it is feasible to declare that an accomplishment has been made. Note that the measurements were performed at 13°C.



Fig. 6. Photographs of snowdrifts on the water channel and anti-erosion walls due to snowfall and snow plowing from the road on February 6-7, 2023.



Fig. 7. The water quality measurements

Instead of using ground or surface water for irrigation, rainwater may be collected and used in certain periods. There is an irrigation dam in the nearby area, where water can be transported

**4TH INTERNATIONAL LATIN AMERICAN  
CONGRESS ON NATURAL AND APPLIED SCIENCES**

naturally to be used during the agricultural irrigation season. Collected precipitation water can be stored in certain tanks or an irrigation dam. Fig. 8 shows the study area and the delivery of collected water to an agricultural irrigation dam.



Fig. 8. Study area and transmission of collected water to an agricultural irrigation dam

The collected water can be conveyed directly to the irrigation dam or the pools with the drainage system or a modern system can be installed as in Fig. 9. Fig. 9 shows a modern water management system using a storage tank. It will be easy to deliver water to the irrigation dam thanks to this design's ability to improve the quality of the surface water. In this system, the natural flow method can be used as well as the pump can be used.

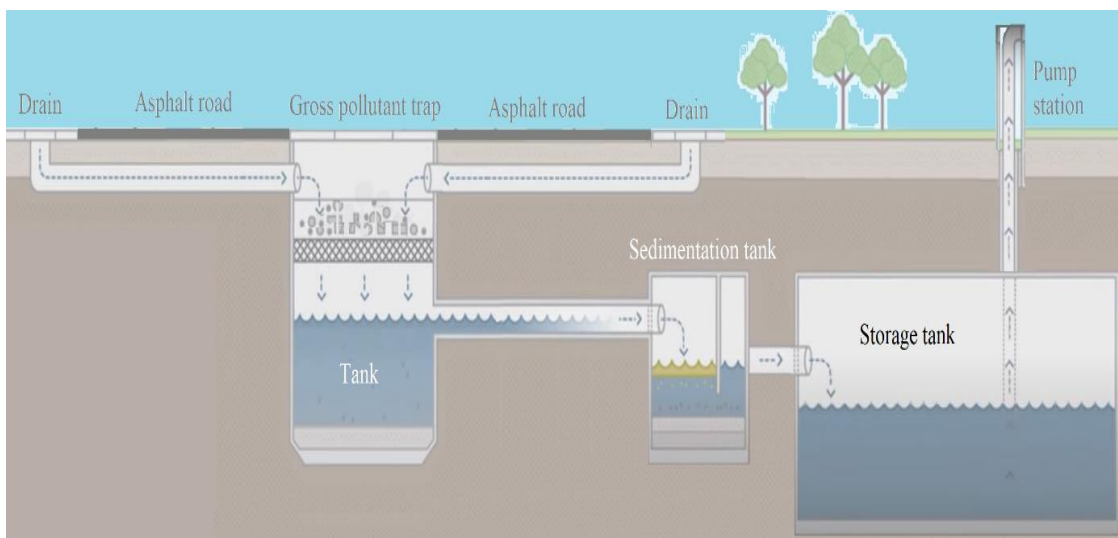


Fig. 9. A sustainable precipitation collection system (It is representative)



#### **4. Conclusion**

It has been attempted to ascertain if the highway surface drainage system can be employed as a method for collecting precipitation water in this study. The drainage line's total length is about 4900 m. The total amount of water that comes with snow for the period between January 26 and February 2, 2023, has been calculated as 377300 m<sup>3</sup>. On February 2, 2023, 14635 m<sup>3</sup> of water was harvested by snowmelt. Water quality levels between 18 and 39 ppm were found using measurements made at various locations. It has been observed that the studied region has a serious potential for a rainwater harvest. When the gaps in the drainage line are also arranged, the drainage line can reach a total of 6700 m (3350 m on the right and left). In this case, the water capacity will increase significantly.

In case, the study area is desired to be transformed into a rainwater harvesting system.

- In its current condition, water can be collected, but it needs to be rearranged.
- In the current state of the existing canals, water can be collected but needs to be rearranged.
- A sustainable precipitation collection system can be established, as in Fig. 8.
- The collected water must be conveyed to the dam used for agricultural irrigation by a pipeline or water collection pond(s) should be constructed at the lowest position of the study area.
- Regular cleaning and maintenance to avoid blockage and guarantee proper flow. Maintenance may be carried out once a year, ideally right before the rainy season starts.
- Erosion control should be done at the outlet of the drain and the culvert.
- The drainage line has to be cleared of any obstruction.
- People have to be educated about proper garbage disposal.

The design of highways and highway drainage systems may be better understood with the help of this study. In many countries, proper maintenance of road drainage structures is overlooked on most roads that are more or less intense. When such water collection systems are implemented, better maintenance of water channels can be provided, which increases the safety of the roads.

**References**

- Aktaş, A., Şevik, S., Aktaş, Ş. (2021). Rainwater harvesting in a 600 kW solar PV power plant. ISPEC 7th Int. Conference on Agriculture, Animal Sciences and Rural Development, 18-19 September 2021, 1116–1124, Muş, Turkey.
- Ghisi, E., Fonseca Tavares D., Rocha, V.L. (2009). Rainwater harvesting in petrol stations in Brasília: Potential for potable water savings and investment feasibility analysis. *Resources, Conservation and Recycling*, 54 79–85.
- Kayhanian, M., Li, H., Harvey, J.T., Liang, X. (2019). Application of permeable pavements in highways for stormwater runoff management and pollution prevention: California research experiences. *International Journal of Transportation Science and Technology*, 8(4), 358–372.
- Kaya, M. (2020). Evaluation of the existing solar energy and rainwater potential in the total roof area of buildings: Izmit district example. *Advances in Materials Science and Engineering*, 8167402, 16 pages.
- Ozioma, O.C. (2022). A Drainage System for Road Construction on Flat Terrain. In (Ed.), *Applied Methods in Design and Construction of Bridges, Highways and Roads - Theory and Practice*. IntechOpen.
- Rokade, S., Agarwal, P.K., Shrivastava, R. (2012). Study on drainage related performance of flexible highway pavements. *Int. J. Adv. Eng. Tech.*, 3(1), 334–337.
- Şevik, S. (2016). Modeling of a multi-functional solar-asphalt energy harvesting and snow-ice prevention system for sustainable superstructures. *TÜBAV Sci. J.*, 9(1), 1–16.
- Şevik, S. (2021). Evaluation of energy production on highways and energy harvest from asphalt roads. 3rd International November 24 Head Teacher Education and Innovative Sciences Symposium, Baku, Azerbaijan, 22–41.
- Şevik, S., Aktaş, A. (2022). Performance enhancing and improvement studies in a 600 kW solar photovoltaic (PV) power plant; manual and natural cleaning, rainwater harvesting and the snow load removal on the PV arrays. *Renewable Energy*, 181, 490–503.

IN HISTORICAL BUILDINGS DAMAGE CAUSITIVE STRUCTURE PHYSICS  
FACTORS

TARİHİ YAPILARDA HASARA SEBEP OLAN YAPI FİZİĞİ ETKENLERİ

Özlem ÖZKAN ÖNÜR

DÜZCE ÜNİVERSİTESİ

ORCID NO: 0000-0002-4110-4936

ÖZET

Kent ve çevre kimliğine katkı sağlayan, geleneksel ve yöresel yaşam biçimini yansıtan yapılar tarihi ve estetik değer taşımaktadır. Kültürel, sosyal ve ekonomik kayıplara neden olan yapılar geri dönüşü olmayan durumlarla karşı karşıya kalmaktadır. Ayrıca ortam koşullarından etkilenen ve inşaları sırasında yapılan tasarım ve uygulama hatalarından kaynaklanan birçok problemlerinde oluşmasına neden olmuştur. Çalışmanın birinci aşamasında, kültür yapılarımızın nitelikli örneklerini içeren Sakarya ili Taraklı ilçesinde yer alan sivil mimariler yerinde incelenerek fotoğraflarla belgelenmiştir. İkinci aşamada, yapılar üzerinde incelemeler yapılarak yapılarda kullanılan malzeme ve geçirdiği onarımlar hakkında değerlendirmelerde bulunulmuştur. Bu değerlendirmelerden elde edilen verilerin çevresel etkenler, fiziksel ve mekanik etkenler, biyolojik etkenler, yapı fiziği problemleri ve kullanıcı kaynaklı sorunlar olduğu ortaya çıkarılmıştır. Kültür varlıklarımızı etkileyen yapı fiziği problemleri (nem, ısı, ses, güneş yangın ve korozyon) yapıların taşıyıcı sistemlerinde geri dönüşü olmayan bozulmalara yol açarak önemli ölçüde tarihi yapıların tahribatına neden olmaktadır. Bu çalışmanın amacı; kültür varlıklarımızın gelecek kuşaklara aktarılmasını riske sokmamak için seçilen örneklem alanında karşılaşılan mevcut sorunlar özellikle yapı fiziği problemleri tespit edilmiştir. Bu tespitlerle korunması gerekli yapılara özgün ölçütte önlemlerin alınabilmesi için gelecekte karşılaşılabilecek benzer olumsuzluklara karşı ışık tutabilecek önerilerde bulunulmuştur.

**Anahtar Kelimeler:** Bozulma, Sivil Mimarlık Örnekleri, Yapı Fiziği Problemleri.



## **ABSTRACT**

Contributing to the city and environmental identity, buildings reflecting traditional and regional life style it has historical and aesthetic value. Structures that cause cultural, social and economic losses are faced with irreversible situations. In addition, it has caused many problems that are affected by environmental conditions and caused by design and application errors made during construction. In the first stage of the study, civil architectures in the Taraklı district of Sakarya province, which contain qualified examples of our cultural structures, were examined on site and documented with photographs. In the second stage, by examining the buildings, evaluations were made about the materials used in the buildings and the repairs they had undergone. It has been revealed that the data obtained from these evaluations are environmental factors, physical and mechanical factors, biological factors, building physics problems and user related problems. Building physics problems (humidity, heat, sound, sun, fire and corrosion) affecting our cultural assets cause irreversible deterioration in the bearing systems of the structures and cause the destruction of historical buildings to a large extent. The aim of this study in order not to risk the transfer of our cultural assets to future generations, the current problems encountered in the selected sample area, especially the problems of building physics, have been identified. With these findings, In order to take measures specific to the structures that need to be protected, Suggestions have been made to shed light on similar negativities to be encountered in the future.

**Keywords:** Deterioration, Examples of Civil Architecture, Building Physics Problems.

## **1. INTRODUCTION**

Contributing to the city and environmental identity, buildings reflecting traditional and regional life style it has historical and aesthetic value. Structures that cause cultural, social and economic losses are faced with irreversible situations. In addition, it has caused many problems that are affected by environmental conditions and caused by design and application errors made during construction.

The properties of the building materials and the application conditions directly affect the durability of the building. For this reason, mistakes and deficiencies in the production and application processes of the building and building materials cause the structures to be damaged and destroyed over time. In addition to using a suitable material in the building production process, it is necessary to prevent the material from deteriorating over time and not losing its performance.

Buildings are damaged over time due to environmental factors. It is caused by wrong design, wrong material selection, wrong workmanship and outdoor conditions. Mechanical effects, heat effects, water and moisture effects, physico-mechanical effects are called building physics problems. Building physics factors cause damage to the structure over time and deterioration of human health and comfort conditions.

## **2. CAUSES OF BUILDING PHYSICS PROBLEMS**

### **2.1. Mechanical Effects**

Made up of structures cracks are caused by mechanical effects. Causes such as faulty workmanship, insufficient material selection, expansion, contraction or vibration of the floor, deflection of beams, excessive load, wind, snow can cause cracks in structures (Güler, 2010).

### **2.2. Heat Effects**

Heat factors such as heat expansion, frost, sun effect and fire are one of the building physics problems. Capillary cracks in building materials, stresses arising from the effect of frost cause physical breakage and fragmentation of materials (Torraca, 1988). The use of materials with different expansion coefficients in buildings causes deformations in the materials, and the problems caused by the effect of the sun cause color changes (Yüzer vd., 2000).

### **2.3. Water and Humidity Effects**

The penetration of water into the material is called penetration, and the increase in the volume of the building material as a result of getting wet is called swelling. Rain water, snow, ice and ground water cause an increase in moisture within the stone in different ways (Ziyaettin, 2010).

With the effect of the moisture rising from the ground and the salts it carries, flowering occurs in the building material. Humidity caused by condensation, rain and fog humidity, and moisture rising from the soil by capillary cause physical and chemical deterioration in the material (Küçükkaya, 2004).

They occur due to wetting and humidity, atmospheric effects and plumbing failures. Water and humidity damage the exterior and interior walls, roof coverings, wet floor coverings, balconies and railings of the buildings.

## **2.4. Physico-Chemical Effects**

Corrosion occurs as a result of oxidation of metal or alloy. Physico-chemical effects such as corrosion, sun and inflorescence cause pollution in the structures and chemical and physical deteriorations occur in the materials.

The aim of this study in order not to risk the transfer of our cultural assets to future generations, the current problems encountered in the selected sample area, especially the problems of building physics have been identified.

In the first stage of the study, the civil architectures in the Taraklı district of Sakarya province, which contain qualified examples of our cultural structures, were examined on site and documented with photographs. In the second stage, evaluations were made about the materials used in the buildings and the repairs they had undergone by examining the buildings.

## **3. EXAMINATION OF BUILDING PHYSICS EFFECTS IN TARAKLI HOMES**

### **3.1. Investigation of mechanical effects**

The Taraklı houses, which were chosen as the sample area, were examined and the mechanical effects that caused the building physics factors were examined. As shown Figure 1. Ayşe Sezgin House of bending caused by mechanical effect on the floor covering is given.



**Figure 1.** Ayşe Sezgin House of bending caused by mechanical effect on the floor covering. As shown Figure 2. and Figure 3. Ayşe Sezgin House of bending caused by mechanical effect on the ceiling covering is given.



**Figure 2.** Ayşe Sezgin House of bending caused by mechanical effect on the ceiling covering.



**Figure 3.** Nevzat Akay House of bending caused by mechanical effect on the ceiling covering.

As shown Figure 4. İbrahim Pilavcı House of breaks in balcony railing due to mechanical effect is given.





**Figure 4.** İbrahim Pilavcı House of breaks in balcony railing due to mechanical effect.

### 3. 2. Investigation of heat effects.

As shown Figure 5. Ayşe Sezgin House of Deteriorations caused by the effect of heat on the exterior of the structure is given.



**Figure 5.** Ayşe Sezgin House of Deteriorations caused by the effect of heat on the exterior of the structure.

**4TH INTERNATIONAL LATIN AMERICAN  
CONGRESS ON NATURAL AND APPLIED SCIENCES**

As shown Figure 6. İbrahim Pilavcı House of deteriorations caused by the effect of heat on the exterior of the sturcture, Figure 7. and Figure 8. Nevzat Akay House of deteriorations caused by the effect of heat on the exterior of the sturcture are given.



**Figure 6.** İbrahim Pilavcı House of deteriorations caused by the effect of heat on the exterior of the sturcture.



**Figure 7.** Nevzat Akay House of deteriorations caused by the effect of heat on the exterior of the sturcture.





**Figure 8.** Nevzat Akay House of deteriorations caused by the effect of heat on the exterior of the sturcture.

### 3.3. Investigation of the effects of water and humidity

As shown Figure 6. Ayşe Sezgin House of moisture formation on the wall surface due to water and humidity, Figure 10. and Figure 11. Ayşe Sezgin House of deterioration of the wall surface due to water and moisture are given.



**Figure 9.** Ayşe Sezgin House of moisture formation on the wall surface due to water and humidity.



**Figure 10.** Ayşe Sezgin House of deterioration of the wall surface due to water and moisture.



**Figure 11.** Ayşe Sezgin House of deterioration of the wall surface due to water and moisture.

### 3.4. Investigation of phsico-mechanical effects

As shown Figure 12. Ayşe Sezgin House of crack caused by mechanical action on the wall surface and Figure 13. Ayşe Sezgin House of corrosion induced deterioration in flooring are given.



**Figure 12.** Ayşe Sezgin House of crack caused by mechanical action on the wall surface.



**Figure 13.** Ayşe Sezgin House of corrosion induced deterioration in flooring.



**4TH INTERNATIONAL LATIN AMERICAN  
CONGRESS ON NATURAL AND APPLIED SCIENCES**

As shown Figure 14., Figure 15., Figure 16. and Figure 17. İbrahim Pilavcı House of crack caused by mechanical action on the wall surface are given.



**Figure 14.** İbrahim Pilavcı House of crack caused by mechanical action on the wall surface.



**Figure 15.** İbrahim Pilavcı House of crack caused by mechanical action on the wall surface.



**Figure 16.** İbrahim Pilavcı House of crack caused by mechanical action on the wall surface.



**Figure 17.** İbrahim Pilavcı House of crack caused by mechanical action on the wall surface.

It has been revealed that the data obtained from these evaluations are structure physics problems such as environmental factors, physical and mechanical factors, chemical and biological factors, and user-related problems.

#### **4. RESULT**

Building physics problems affecting our cultural assets cause irreversible deterioration in the bearing systems of the structures and cause the destruction of historical buildings to a great extent.

In order to historical buildings be long-lasting, problems arising from building physics problems should be determined. Then, measures should be taken to prevent the original texture of the structures from deteriorating. According to the necessary protection methods, applications should be made with original materials suitable for the environment.

Attention should be paid to material compatibility, correct workmanship and the application of correct construction techniques in structures. Measures should be taken against deterioration caused by thermal factors applying heat insulation material on exterior and interior facades against heat expansion. Water and moisture-related problems should be also prevented by applying waterproofing material to prevent water from entering the structure.

#### **5. REFERENCES**

- Ahunbay , Z. (1998). Tarihi Çevre Koruma ve Restorasyon, Yapı Yayın, İstanbul.
- AKMAN, M. S., (2000). Yapı Hasarları ve Onarım İlkeleri, TMMOB İnşaat Mühendisler Odası, İstanbul.
- Eser, F., & Yardımlı, S. (2017). Tunceli İli Meşeyolu Köyü Yapılarının Yapı Fiziği Açısından Değerlendirilmesi, Bilim ve Gençlik Dergisi, c.2, v.5, 96-112.
- Günay, R. (2002). *Geleneksel Ahsap Yapılar Sorunları ve Çözüm Yolları*, Birsen Yayınevi, İstanbul, 2002.
- Mihlayanlar, E. (2005). Binalarda Hasra Sebep Olan Yapı Fiziği Etkenler, *Yüksek Lisans Ders Notları*, Edirne.
- Özkan, Ö. (2009). Taraklı Sivil Mimarlık Örnekleri ile Halim Düzgün Evi'nin Proje ve Ali Pektaş Evi'nin Restorasyon Çalışmaları, Yüksek Lisans Tezi, Sakarya Üniversitesi, Fen Bilimleri Enstitüsü, Sakarya.



**4TH INTERNATIONAL LATIN AMERICAN  
CONGRESS ON NATURAL AND APPLIED SCIENCES**

- Özkan Önür Ö. & Yerli, Ö. (2019). *Sivil Mimarlık Örneklerinden Ayşe Sezgin Evi'nin Restorasyonu*. Mimarlık, Planlama ve Tasarım Alanında Araştırma Makaleleri, ss.201-219.
- Özkan Önür, Ö., Apay, A. C. & Mutlu, E. (2022). Tarihi Yapılarda Koruma Fatma Sevim Dönmez Evi. *Kültürel Miras Araştırmaları Dergisi*, c.3, v.1, 17–25.
- Güler, H., Sezer Ş., & Ülkü, S. (2010). Binalarda Yapı Fiziği Problemleri: Bursa'da Bir Kamu Kurumu Örneği, *Uludağ Üniversitesi Mühendislik-Mimarlık Fakültesi Dergisi*, c.15, vol. 2, 53-64.
- Küçükkaya A. G. (2004). *Taşların Bozulma Nedenleri Koruma Yöntemleri*. Birsen Yayınevi.
- Taraklı Belediye Arşivi, 2009.
- Torraca G. (1988). *Porrous Building Materials, Science for Architectural Censervation*. Iccrom.
- Yüzer, E., Gürdal, E., Ersen, A., Güleç, A, Eyüboğlu R., Eriş, İ., Görür, N., Vardar, M., Suner, F., Mahmutoğlu, Y., & Pehlivanoğlu, C. (2000). *Dolmabahçe Sarayı, Kullanılan Taşların Korunmuşluk Durumlarının ve Ayrışma Nedenlerinin Belirlenmesi*, Koruma ve Onarım Yöntemlerinin Saptanması Projesi Koruma ve Onarım Yöntemlerinin Saptanması Projesi, İstanbul Teknik Üniversitesi Geliştirme Vakfı Araştırma Projesi Raporu, İstanbul.
- Ziyaettin, N. (2010). 'Kimyasal Uygulamalarının Kuzey Kıbrıs Yapı Taşlarının Dürabilitesi Üzerine Etkisi', Doktora Tezi, İstanbul Teknik Üniversitesi Fen Bilimleri Enstitüsü, İstanbul, Türkiye.

**4TH INTERNATIONAL LATIN AMERICAN  
CONGRESS ON NATURAL AND APPLIED SCIENCES**

**SATELLITE MUSEUMS AND ITS IMPACT ON URBAN SPACE**

**UYDU MÜZELER VE KENTSEL MEKANA ETKİLERİ ÜZERİNE BİR İNCELEME**

**Ceren AĞIN GÖZÜKIZIL**

Ar.Gör.Dr., Muş Alparslan Üniversitesi

ORCID NO: 0000-0002-2032-4921

**Senem TEZCAN**

Dr., İstanbul Büyükşehir Belediyesi

ORCID NO: 0000-0003-0532-8825

**ÖZET**

Kentler, küreselleşmenin baskın bir akım olarak kentleri biçimlendirdiği 1980 sonrası dönemde birbirleriyle rekabet içerisine girmişlerdir. Bu yarışmacı süreç kentleri kendi markalarını yaratmaya, olumlu yönlerini öne çıkarmaya yönelik uygulamalar yaparken olumsuzluklarını bertaraf etmeye, tehditleri ortadan kaldıracak ve potansiyellerini maksimum seviyede kullanabilecek stratejiler yaratmaya itmiştir. Her kent daha zengin turist ve yatırımcıyı kentine çekmeyi istemektedir. Özellikle hizmet sektörünün ekonomik pay dağılımındaki artan oranı turistik faaliyetlerden biri olan kültür eksenli küresel hareketliliği de öne çıkarmıştır. Organizasyon ve etkinliklere ev sahipliği yapmak önemsenen bir strateji haline gelmiştir. Bu etkinlikler süreli veya süresiz şeklinde gruplanmaktadır. Müzeler ve özellikle tematik nitelikte olanlar gerek mimarisıyla gerekse sergiledikleri ürünlerle kendileri birer çekim noktası haline gelmişlerdir. Müzeler de nitelik farklı gruplara ayrılmaktadır. Bunların buldukları kente etkileri bulunmaktadır. Ancak bu çalışma son dönemlerde daha da görünür olan ve dünya çapında da birçok örneklerini gördüğümüz uydu müzelerle odaklanmaktadır. Yirmi birinci yüzyılın bu yeni uydu modelinde merkez müzeler sahip oldukları eserleri farklı kent veya ülkedeki uydu müzelerle aktarmaktadır. Böylesi bir akışta asıl müzenin bilinirliği artmakta; uydu müzeler ise buldukları kent parçasında birer öncü proje özelliği ile çevresini dönüştürmektedir. Çalışma kentlerin markalaşması bakış açısından başlayarak bir pazarlama stratejisi olarak müzeleri ve uydu müzeleri tanımlamayı ve bu tip yapıların kentsel mekanlar üzerindeki etkilerini kuramsal çerçeve ve dünya örnekleri üzerinden ortaya çıkarmayı amaçlamaktadır.

**Anahtar Kelimeler:** Müze, Uydu Müze, Turizm, Küreselleşme

**4TH INTERNATIONAL LATIN AMERICAN  
CONGRESS ON NATURAL AND APPLIED SCIENCES**

**ABSTRACT**

Cities entered into competition with one another in the post-1980 period, when globalization shaped cities as a dominant trend. This competitive process has pushed cities to create their brands, eliminate their negative aspects, create strategies that will eliminate threats, and use their potential at the maximum level while making practices to highlight their positive aspects. Every city wants to attract richer tourists and investors to its city. In particular, the increasing rate of the service sector in the economic share distribution has also highlighted cultural-oriented global mobility, which is one of the touristic activities. Hosting organizations and events has become an important strategy. These activities are grouped as temporary or indefinite. Museums, especially the thematic ones, have become points of attraction with their architecture and the products they exhibit. Museums are also divided into different groups. These have effects on the city in which they are located. However, this study focuses on satellite museums, which have become more visible in recent years and we see many examples around the world. In this new satellite model of the twenty-first century, central museums transfer their works to satellite museums in different cities or countries. In such a flow, the awareness of the original museum increases; Satellite museums, on the other hand, transform their surroundings with the characteristics of pioneering projects in the part of the city they are located in. The study aims to define museums and satellite museums as a marketing strategy, starting from the point of view of the branding of cities, and to reveal the effects of such structures on urban spaces through a theoretical framework and world examples.

**Keywords:** Museum, Satellite Museum, Tourism, Globalization

**4TH INTERNATIONAL LATIN AMERICAN  
CONGRESS ON NATURAL AND APPLIED SCIENCES**

**SECURITY VULNERABILITIES IN CLOUD TECHNOLOGY**

**Asst. Prof. Dr. Murat KOCA**

Van Yuzuncu Yil University, Faculty of Engineering, Computer Engineering

ORCID ID: <https://orcid.org/0000-0002-6048-7645>

**Asst. Prof. Dr. İsa AVCI**

Karabük University, Faculty of Engineering, Computer Engineering

ORCID ID: <https://orcid.org/0000-0001-7032-8018>

**ABSTRACT**

Cloud technologies have been widely used in recent years with the development of technology. The widespread use of cloud technology makes it attractive for attacks. The most important difference between the attacks that cloud technology is exposed to is that it is accessible to all devices in the same ecosystem. This situation increases the course and amount of attacks. Cyber attacks and their methods are also changing and developing in the cyber world, which is developing more each day. Today, an important part of the attacks that cloud tools are exposed to, the increasing number of users, consists of attacks on users. Social hacking has become very common, especially with the use of social media. Due to the presence of unconscious users, a large number of attacks take place. Cloud services are constantly open to the outside world, which also makes them vulnerable to attack. Cloud service providers are also trying to provide security with two-factor authentication, authentication, and end-to-end encryption to remedy these attacks. In this study, the advantages and disadvantages of cloud technology were also investigated. In this study, detailed research was conducted on the security vulnerabilities of cloud technology.

**Keywords:** Cloud Technologies, Cloud Technologies Security, Security Vulnerabilities

## **1. INTRODUCTION**

Developments in electronic and communication tools have been at an unprecedented pace in recent years. Every day, new technology or innovation takes its place in our lives. It is also possible for people and devices to communicate with each other, transfer data, and store data in one place, thanks to cloud technology. The fact that data can be stored, transferred to many places simultaneously, and accessible at any time and any hour makes cloud technologies attractive. The development of cloud computing dates back to the 1960s.

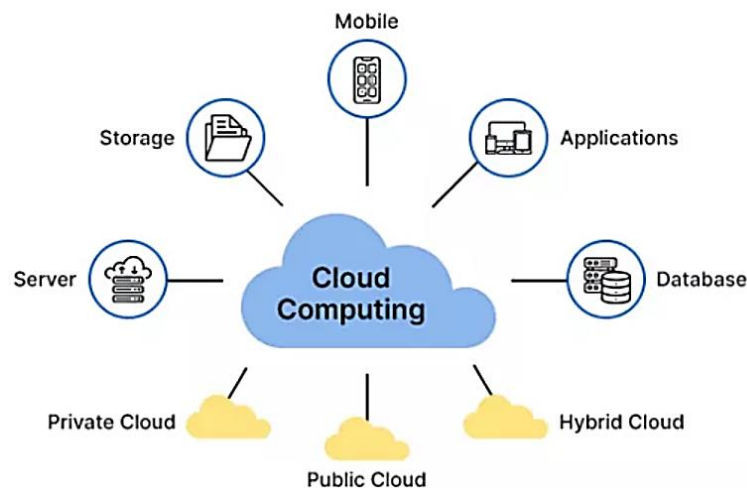
Cloud computing is a set of virtual services that ensure that data is stored in another environment, accessible on the internet, that acts with a pay-as-you-go mentality, and allows users to pay only for the service they use (Srinivasamurthy et al., 2013). Cloud technologies are useful and easily accessible technology that enables users to store their data and applications in a remote environment and to make them accessible whenever they want. Ease of administration, configuration, access, and service advantages make it a popular service provider[2]. It provides services for personal or corporate use purposes. In the current age, it can be said that there is no area where there is no internet and communication is not provided. Even the progress in the last few years is much greater than in previous decades. Cloud computing technology has also overtaken classical storage and data transfer activities. These systems are used more frequently in the business world and provide fast and secure data transfer, storage, easy manageability, and ease of access. The intense demand for cloud computing causes the rapid development of this field and various security needs.

Cloud computing has a distributed system architecture with open-source software. The information on the user data and the physical addresses where this data is stored are not shared (Sun, 2020). One of the advantages of cloud computing is that it can be accessed from anywhere in the world and handle various tasks. It can be moved on the cloud through browsers and provides great mobility in the corporate sense. This makes cloud computing products attractive, which also avoids classical storage costs. This study will discuss the security and vulnerabilities of cloud computing products.

## **2. CLOUD COMPUTING TECHNOLOGIES**

It is a technology that has started to be developed since the 1960s and provides services in

areas such as data storage and data transfer. It is a system that allows storing data on the Internet, thus freeing users from physical storage devices and environments and providing access anywhere at any time. Devices in the cloud ecosystem are not physically connected. Remote network servers provide this service. It can also be called the virtualization of data. It is designed to store data securely, manage easily, run applications, and transmit content and services. It can be accessed from any device connected to the internet (Bhajantri and Mujawar, 2019).



**Figure 1.** Cloud Computing (Myrasecurity, 2023).

Cloud deployment types are divided into 4 main classes public cloud, private cloud, hybrid cloud, and community cloud. These distribution models emerged as a result of determining individual and institutional needs. It can be perceived as an advantage that it is divided into these distribution types in terms of cost and security. Individuals and organizations have different security needs, and the security of these distribution types differs. Since the number of users using corporate products is more than one, they are always open to security threats. The threat level is increasing, especially when users are unaware of this. Users should be made aware of attack methods and safe use (Goumidi et al., 2020).

## **2.1. Cloud Deployment Types**

### **2.1.1. Public Cloud**

A public cloud is a type of cloud deployment that anyone can use and whose security the service provider determines privacy, profit rate, expenses, and prices. The most popular cloud instances are Google Drive, Amazon, iCloud, Dropbox, Yandex Disk, and One Drive. There



are paid and free versions according to the service provider's approach. For example, Google Drive gives free storage of up to 15GB.

### **2.1.2. Private Cloud**

A private cloud is a service where users provide resources such as data storage and data transfer in their ecosystem. This cloud system is the service the organization provides with its servers. A private cloud is a cloud infrastructure that serves a single organization without outside user access (Mell and Grance, 2011). A private cloud is easier to secure as there is no outside access. Since it is the service the organization provides, it can be more flexible in establishing security. Although it is an open system to the Internet, it can only be accessed by authorized persons, making this system more secure.

### **2.1.3. Community Cloud**

The community cloud deployment type consists of cloud infrastructure as several collaborative entities. Organizations in the ecosystem can access applications and data in the cloud. They have the same security system, reliability, and workspace. Today, government institutions also use the common cloud infrastructure (Mell and Grance, 2011). It uses a central and shared cloud infrastructure and reduces threats such as task and load distribution and security and facilitates the work done in this context. The main purpose of this project is to act on the common interest by working in harmony and security.

### **2.1.4. Hybrid Cloud**

This type of cloud deployment has emerged from a variety of security needs. It works as a combination of private and public clouds. It is the way two or more clouds work together. Clouds are different, but they work in conjunction with each other. This allows the use of multiple placement models (Steven, 2011). This type of cloud creates a resource pool based on a consistent infrastructure. Companies deliver higher performance, efficiency, reliability, and security across all cloud models by using the same tools, environments, rules, and teams.

## **3. CLOUD TECHNOLOGY ADVANTAGES AND DISADVANTAGES**

### **3.1. Cloud Technology Advantages**

Cloud computing has many advantages for personal and corporate use. However, it is more prominent in corporate use. It provides many advantages over the price-performance index. It provides benefits in many aspects, from the energy consumed per unit of time to the costs of the equipment used (Alouffi et al., 2021; But et al., 2020).

## **4TH INTERNATIONAL LATIN AMERICAN CONGRESS ON NATURAL AND APPLIED SCIENCES**

- It can make a backup in case the units where it stores the data are damaged, and it can perform backup recovery whenever it wants.
- Since there is common registration and common access in the common cloud system, every user can easily access and make the necessary changes whenever they want. It helps save time and workload.
- Information can be accessed wherever there is an internet connection. It also prevents the problem of dependence on the institution in corporate affairs.
- Instead of using expensive products for information technology management and data storage, it can use as much as it needs and pay for what it uses.

### **3.2. Cloud Computing Disadvantages**

As with any technology product, cloud computing has both advantages and disadvantages (Sputniknews, 2023).

- Since all data is stored on the internet, there will be no access from a place without a strong internet connection. There is no other way to access the cloud.
- Since the supplier company provides cloud computing security and reliability, users can not work on this issue. Due to these attacks, there is always the possibility of cyber-attacks and data being accessed by third parties. For example, in the past years, the iCloud system has been attacked, which has caused many users' data to be stolen.
- The continuous online presence of the cloud system makes it vulnerable to cyber-attacks. Even professionals who are good in their field can suffer from security weaknesses due to attacks from time to time.
- Cloud systems can also be costly for small businesses in the short term. This contrasts with the main purpose of cloud technology, the reduction of storage costs.

### **4. SECURITY VULNERABILITIES OF CLOUD COMPUTING**

One of the most fundamental problems of cloud computing is security. Unauthorized persons gain access to the cloud system and may steal data for many reasons, such as working online and occasionally being used by unconscious users. Considering that one of the most practical issues of our time is to have data, this is a great danger in itself. It will also lower the reliability of the cloud system provider if the data is stolen (Rewagad and Pawar, 2013).

Software user interfaces and APIs control cloud systems. Although cloud providers are constantly working to develop interfaces and APIs, these developments also bring security vulnerabilities. It is necessary to close these gaps regularly and continuously, and the system

## **4TH INTERNATIONAL LATIN AMERICAN CONGRESS ON NATURAL AND APPLIED SCIENCES**

should be made more secure by constantly updating it. One of the most common problems is password reuse. Passwords previously saved in the system may not be deactivated after changing them. This makes it exploitable by attackers (Tripathi and Abhinav, 2011).

Configurations made to facilitate access and management of information may also cause vulnerabilities in the system. Theft of the password is not a desirable situation as it can be used over many accounts. It can have dire consequences when it comes to data leakage. For example, user data registered to a shopping site called Yemek Sepeti was stolen in recent years. Many users' information, from address information to credit card information, was stolen, and users were victimized in this regard (Tirumala et al., 2015).

Organizations are obliged to comply with rules such as the Personal Data Protection Law. In this regard, it is obliged to limit the data. The theft of information such as credit card information may cause damages that are difficult to compensate users. Many measures can be taken in these matters. Methods such as cryptology software, making data independent from each other, and physical separation can be used.

### **5. CONCLUSION**

In this study, evaluations were made on the importance of the security of cloud computing software, a technology used in almost every field today, and its usage areas are constantly increasing. These technologies have security vulnerabilities due to user and direct network attacks. One of the best ways to minimize this vulnerability is to protect the system with up-to-date and constantly updated software. Necessary training should be given to raise awareness of users. There will always be these attacks; data is the most important thing in today's world, and people will make every effort to get it. Although it is difficult to be protected from these attacks, it is not impossible. The development and change of cloud technology will always continue to increase. The more users, the more attractive it will be to attack. In addition to the cloud provider's security measures, the user should also take precautions. As a result, data can be accessed due to the weakness caused by the user. The user and the cloud provider must know their job descriptions well and fulfill their responsibilities within the framework of their responsibilities. Against attacks that may occur during user access, methods such as multi-factor authentication, authentication, and end-to-end encryption should be used. The vast majority of data breaches occur because users are caught phishing. Users need to use it in an educated and conscious way.

### **REFERENCES**

**4TH INTERNATIONAL LATIN AMERICAN  
CONGRESS ON NATURAL AND APPLIED SCIENCES**

Alouffi, B., Hasnain, M., Alharbi, A., Alosaimi, W., Alyami, H., & Ayaz, M. (2021). A systematic literature review on cloud computing security: threats and mitigation strategies. *IEEE Access*, 9, 57792-57807.

Bhajantri, L. B., & Mujawar, T. (2019, December). A survey of cloud computing security challenges, issues and their countermeasures. In 2019 Third International conference on I-SMAC (IoT in Social, Mobile, Analytics and Cloud)(I-SMAC) (pp. 376-380). IEEE.

Butt, U. A., Mehmood, M., Shah, S. B. H., Amin, R., Shaukat, M. W., Raza, S. M., ... & Piran, M. J. (2020). A review of machine learning algorithms for cloud computing security. *Electronics*, 9(9), 1379.

Goumidi, H., Aliouat, Z., & Harous, S. (2020). Vehicular cloud computing security: A survey. *Arabian Journal for Science and Engineering*, 45, 2473-2499.

Mell P. Grance T., The NIST Definition of Cloud Computing, 2009, <http://www.wheresmyserver.co.nz/storage/>.

Myrasecurity, <https://www.myrasecurity.com/en/knowledge-hub/cloud-computing/>, accessed date: 12.02.2023.

Rewagad, P., and Pawar, Y. (2013). Use of Digital Signature with Diffie Hellman Key Exchange and AES Encryption Algorithm to Enhance Data Security in Cloud Computing, *Communication Systems and Network Technologies (CSNT)*, pp. 437-439, 2013.

Sputniknews, <https://tr.sputniknews.com/20181021/apple-icloud-itunes-bitcoin-turkish-crime-family-kerem-albayrak-hack-fidye-1035764707.html>, accessed date: 12.02.2023.

Srinivasamurthy, S., Liu, D., Vasilakos, A., Xiong, N. (2013). Security and Privacy in Cloud Computing: A Survey," *Parallel & Cloud Computing (PCC)*. London, vol. 2, pp126-149, New York, NY: American V-King Scientific Publishing, 2013.

Steven, A., "When Hybrid Clouds Are A Mixed Blessing." May 2011.

Sun, P. (2020). Security and privacy protection in cloud computing: Discussions and challenges. *Journal of Network and Computer Applications*, 160, 102642.

Tirumala, S., Sathu, H., and Naidu, V. (2015). Analysis and Prevention of Account Hijacking based INCIDENTS in Cloud Environment, *International Conference on Information Technology*, pp. 124-129.

Tripathi, A., and Abhinav, M. (2011). "Cloud computing security considerations." *Signal Processing, Communications and Computing (ICSPCC)*, 2011 IEEE International Conference on. IEEE, 2011.

**4TH INTERNATIONAL LATIN AMERICAN  
CONGRESS ON NATURAL AND APPLIED SCIENCES**

**APPLYING UX PRINCIPLES TO FIND PRE-PATTERNS IN HANDHELD  
AUGMENTED REALITY GAMES**

**PUSHKAR PANDEY**

Department of Design, Indian Institute of Technology Kanpur, India

ORCID ID: <https://orcid.org/0000-0002-5894-1036>

**ABSTRACT**

Reality-based interfaces that produce "embodied" game play experiences have recently attracted a lot of attention from the gaming industry and allied research areas. Handheld augmented reality (HAR) is a reality-based interface that superimposes computer-generated imagery (CGI) over a user's view of the actual world. In a HAR environment, players can use their existing physical and social skills to engage with the game system. The application of user experience (UX) design principles to augmented reality (AR) systems has received only a limited amount of research attention. In this study, we look into the potential relevance of such principles to the field of handheld augmented reality game development. The UX design tools such as shadowing, ethnographic research, people and context research, empathy mapping and experience map are used to define the pre-patterns in HAR games.

**Participants** - We select a sample of 23 gamers of the gaming society Indian Institute of Technology Kanpur. After the sample of 23 gamers we select diverse sample of 27 individuals to dive deep into the UX research.

**Keywords** - embodied game, handheld augmented reality (HAR), computer generated imagery (CGI), shadowing, experience map, pre-patterns.

**MULTIAXIAL NON-PROPORTIONAL RANDOM ANALYSIS OF A TYPICAL HUB  
STEERING KNUCKLE WITH RESPECT TO IN-SERVICE LOADING EFFECTS ON  
ITS GEOMETRIC MODEL**

**Aniekan Essienubong Ikpe**

Department of Mechanical Engineering, Akwa Ibom State Polytechnic, PMB. 1200  
ORCID: 0000-0001-9069-9676

**Michael Okon Bassey**

Department of Mechatronics Engineering, Akwa Ibom State Polytechnic, PMB. 1200  
ORCID: 0000-0001-5433-7889

**Etuk Ekom Mike**

Department of Mechanical Engineering, University of Benin, PMB. 1154  
ORCID: 0000-0002-1866-9349

**ABSTRACT**

In this study, the high-strength-lightweight aluminium alloy A356.0-T6 was applied on Toyota Camry LE vehicle steering knuckle model, which remains a strategic component that serves as the link between axle housing, stub axle, and tie rod. An attempt was made to determine the effect of loading conditions (lateral and multiaxial forces) from multi-translated axis that may result in failure of a steering knuckle during its service life. Also, to determine the various loads and moments on the suspension system which is translated to the steering knuckle in its duty cycle. A 3D model was developed using SolidWorks 2018 version while ANSYS workbench R15.0 (2019 version) was used to conduct static structural analysis. The total force on the knuckle hub acting in the Z direction was determined as 3938.715N, which represented total loads on the four tyre of the car. Steering moment of 5400N.mm at perpendicular distance of 108mm, braking force of 3964.63 N.mm and breaking moment of 277,524.73N.mm were achieved. Solid mesh was selected as the type of mesh while blended curvature based mesh was employed as the type of mesher. Maximum equivalent Von-mises stress of 36.079 MPa, equivalent elastic strain of 0.00018393 mm/mm, maximum principal stress of 44.587 MPa and maximum shear stress of 19.871 MPa were obtained. This led to directional deformation of 0.010135 mm, representing bending along the Z-axis and maximum total deformation of 0.069036 mm. Although maximum safety factor of 15 dominated the model as the best value, an average safety factor of 10 was obtained at that current state, with a minimum safety factor of 2.5 found at the bolt bottom hole. The boundary conditions are safe to be adopted in real life events with insignificant or zero catastrophes.

**Keyword:** Steering knuckle, Static analysis, Total deformation, Factor of safety, Failure.

**1. Introduction**

The steering knuckle serves as the link between the axle housing, stub axle, and tie rod. A king pin connects the steering knuckle to the axle housing. It connects to another end towards the tie rod. With the aid of a bearing, the wheel hub is then secured over the knuckle. The steering knuckle's job is to change the tie rod's linear motion into angular motion of the stub axle (Babu et al., 2014). Steering itself is made possible by the steering knuckles, which join the wheel to the suspension system. Although steering knuckles were first used in the 18th century, their popularity has subsequently skyrocketed. On cars, trucks, buses, and other large



and heavy vehicles, you can find them. The suspension system, which enables the vehicle to travel smoothly in different directions, is connected to them, aiding in the steering of the vehicle. The steering knuckle is a component of the car's suspension that is used to turn the wheel. The front wheels, suspension, and steering all come together at the steering knuckles. They offer the attachment places for the tie-rod ends, the spindle and/or hubs that hold the wheels on, the upper and lower control arms or struts and lower arms, and more. The steering knuckles enable the wheels to move both horizontally and vertically in response to steering input and the suspension's response to road imperfections (Li et al; 2022). There are numerous variations of steering knuckles. They have various designs to accommodate various uses and suspension kinds. They can be separated into two categories, though. The other has a spindle, while the first has a hub.

In this research study, a steering knuckle of a Toyota Camry LE saloon car was employed as a study component in this investigation. Weight reduction is a growing concern for the automotive industry. Losing weight will have a significant influence on efforts to cut emissions (greenhouse gases), improve fuel efficiency, and protect the environment. Numerous technical advancements, including those in materials, design and analytical methodologies, fabrication processes, optimization techniques, etc., can lower weight. Throughout its service life, the steering knuckle is subjected to time-varying stresses, which causes fatigue failure. Consequently, an essential component of the product development cycle is its design (Dumbre et al., 2014; Muhamad et al., 2012; Sharma et al., 2014; Kashyzadeh and Farrahi, 2023). Additionally, the need to extend the High-Cycle Fatigue (HCF) life of automobile safety components that experience random, non-proportional multi-input loading is becoming more and more of interest to automotive industry. The steering knuckle experiences the most random stresses from the road and steering, which are applied at multiple spots (i.e., joints of knuckle with lower control arm, steering linkage, and Macpherson strut). Additionally, improper wheel angle adjustment increases the intensity of road stresses. In this regard, earlier research has demonstrated that wheel angles have an impact on the component's service life (Kashyzadeh and Farrahi, 2023; Liu et al., 2023).

Yadav et al. (2016) designed and analysed a steering knuckle component using forged steel EN 47, considering an average vehicle weight of 1240 Kg. The steering knuckle was modelled with Creo (Pro-E) 2.0 while static analysis was carried out using ANSYS workbench 15.0. Maximum total deformation of 0.89651 mm, maximum directional deformation (X-axis) of 0.62675 mm, maximum principal stress of 70.295 MPa, maximum shear stress of 62.111 MPa, Maximum equivalent Von-mises stress of 112.25, maximum equivalent elastic strain of 0.00069023 and maximum shear elastic strain of 0.00080745 were obtained. Apart from the improved yield strength of this material, the mass density (7700 kg/m<sup>3</sup>) and corrosion properties were some of the possible flaws of the material for steering knuckle application. In a similar study were mild steel and mild steel with nickel composite as well as average vehicle weight of 1240 Kg was used, directional deformation of 0.392, 0.21422 and 0.3534 mm at X, Y and Z-axis, total deformation of 1.8643 mm, equivalent elastic strain of 0.026808, maximum principal elastic strain of 0.021241 and equivalent Von-mises stress of 4467.6 MPa were obtained. However, mass density of the materials was also a setback.

Dusane et al. (2016) conducted analysis on All Terrain Vehicles (ATV) steering knuckle. The CAD model was developed using CATIA V5 while ANSYS 12 was used to perform static on aluminium alloys 6061-T6 steering knuckle frame and EN8 material for the spindle. With mass density of 2700 Kg/m<sup>3</sup> and tensile yield strength of 276 MPa, both aluminium 6061-T6 alloy and EN8 were found to be better materials for steering knuckle due to good physical and mechanical properties as well as lightweight.

Kashyzadeh, K. R. (2023) conducted static analysis on a composite steering knuckle, assuming a road condition characterized by roughness and manoeuvres. The in-service driving condition of the vehicle model was simulated using multi-body dynamics (MBD) method, and the imposed loads on connection points of the steering knuckle to different components of the suspension system were extracted considering various maneuvers. CATIA software was used in developing the steering knuckle model by applying coordinate measuring machine (CMM) data. The results revealed that increase in tungsten carbide led to increase in the strength of the steering knuckle under purely axial loads (normal stress criterion) while increase in this substance resulted in a decrease in the strength of the parts subjected to shear loads (shear stress criterion). It was observed that the application of metal matrix composite is not suitable for this super critical component, based on the conditions of the study.

This research seeks to explore for ideas to decipher failure analyses (static analysis) of all kinds that the automotive industry is requesting from manufacturing lines in big quantities with respect to steering knuckles as applicable to Toyota Camry LE saloon car. In other words, a static structural analysis of a typical hub steering knuckle with respect to in-service loading effects on the geometric model, with specific attention on mass density and yield strength of the component material. It makes sense that the steering knuckle would benefit greatly from optimization for either volume or weight. In the same vein, the goal of a static analysis of the steering knuckle is to determine the maximum stresses and deformation that can occur under various conditions, including braking force, load transfer during acceleration and braking, etc. The outcome of will play a critical role in shape optimization which is a unique face sort by manufacturers in the synthesis of such product with enormous functionality and reliability.

## 2. Materials and Method

Steering Knuckle is an element of the suspension of the automobile that is used for turning and the wheel. The steering knuckles are where the suspension and steering systems and the front wheels converge. They provide the attachment points for the upper and lower control arms or struts and lower arms, the tie-rod ends, and the spindle and/or hubs to which the wheels are mounted. The steering knuckles allow the wheels to move vertically as the suspension reacts to road irregularities and horizontally in response to steering input. The knuckle was modelled in SolidWorks 2018. The steering knuckle shown in Figure 1a was modelled after the Toyota Camry LE saloon car. The aluminium alloy A356.0-T6 assigned to the steering knuckle model had mass density of  $2670 \text{ kg/m}^3$  as physical property, and tensile strength (ultimate)  $\geq 234 \text{ MPa}$ , tensile strength (yield)  $\geq 165 \text{ MPa}$ , elongation at break  $\geq 3.5\%$ , shear modulus of  $27.2 \text{ GPa}$ , shear strength of  $143 \text{ MPa}$ , tensile modulus of  $72.4 \text{ GPa}$  and hardness (Brinell) of 70-105 as its mechanical properties. The knuckle was modelled in SolidWorks 2018 and then Analysed by ANSYS R15.0 workbench. This study investigated the hub type steering knuckle. Several multi-translated loads (lateral and multiaxial forces) act on the knuckle in static condition and are illustrated in Figure 1b follows.



Figure 1a: Steering knuckle model

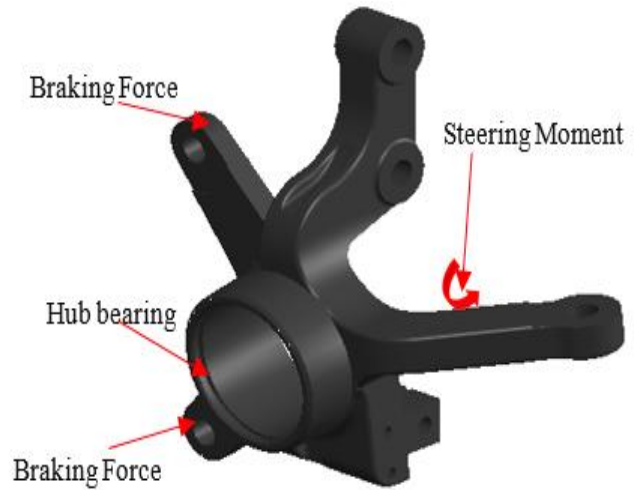


Figure 1b: Forces acting on the steering knuckle

Part assembly drawing of the steering knuckle with dimensions are shown in Figure 2 while mesh visualization of the steering knuckle is presented in Figure 3. The ANSYS workbench mechanical meshing was used with fine relevance centre and slow transition of element, with a total of 116048 nodes and 76870 elements. Solid mesh was selected as the type of mesh while blended curvature based mesh was employed as the type of mesher.

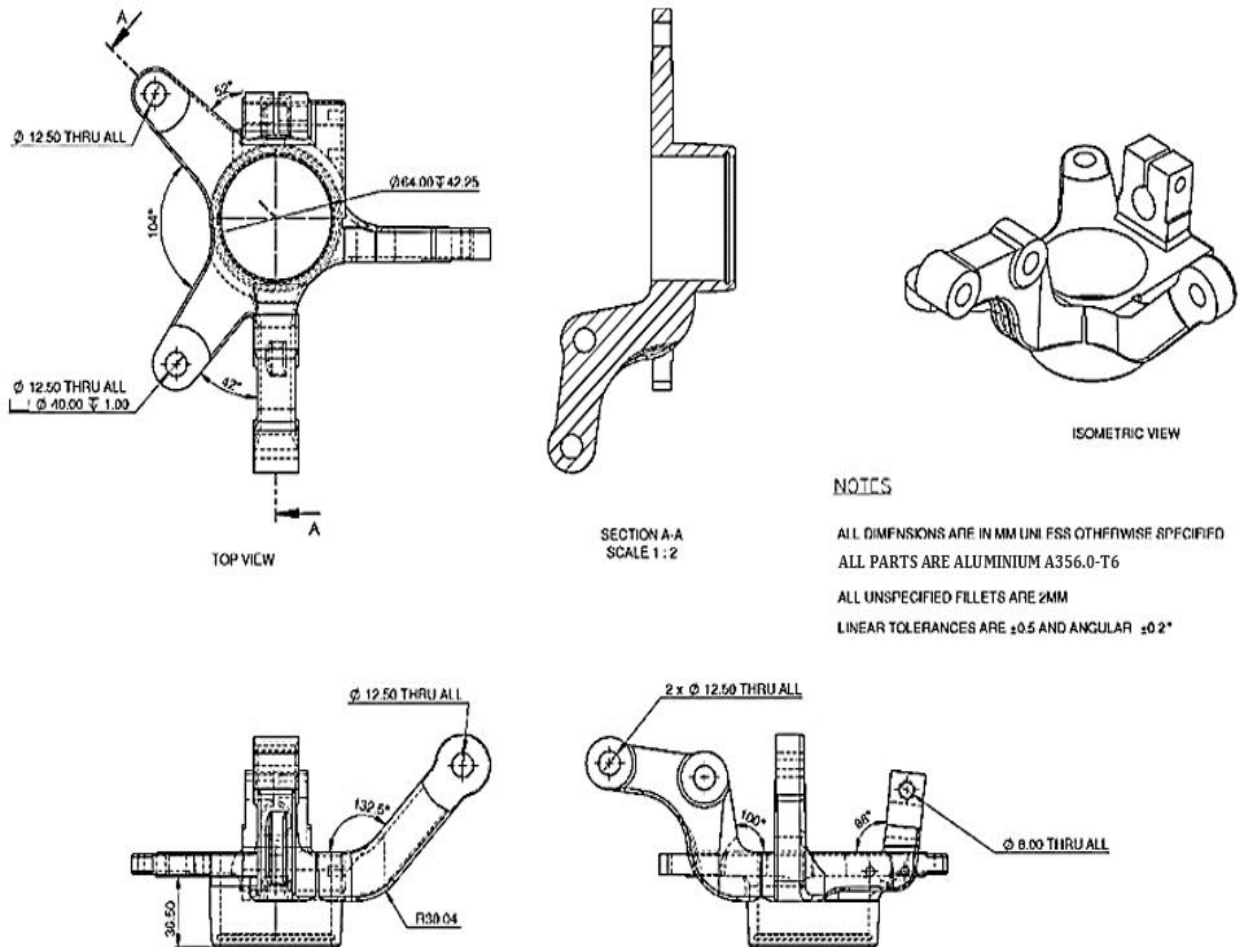


Figure 2: Sketches for steering knuckle with dimensions

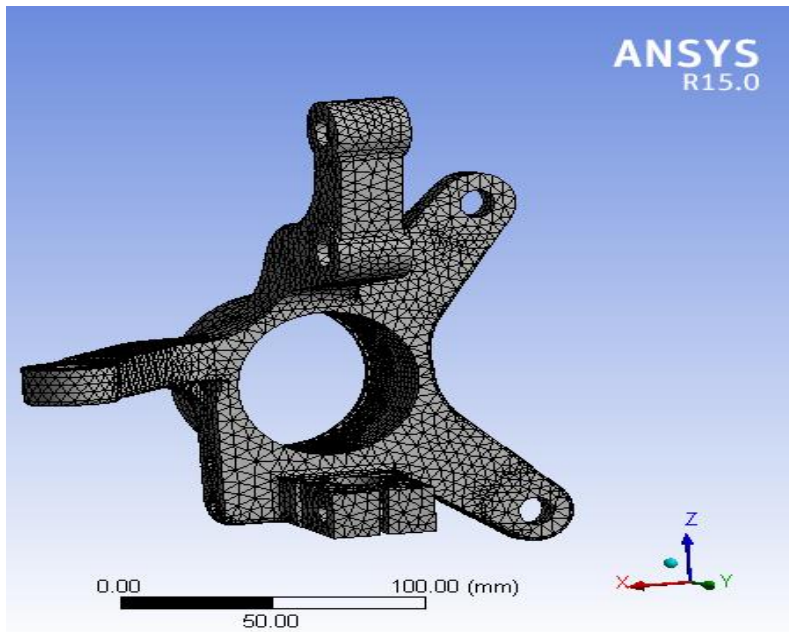


Figure 3: Mesh visualization of the steering knuckle

### 2.1. Loads/Forces Acting on the Steering Knuckle

There are two major type of loads acting on the steering knuckle which includes tensile and compressive load, and other forms of multi-translated loads (lateral and multiaxial forces). The stress due to these loads can be achieved using the following formulas:

$$\text{Tensile load } (P_t) = \text{Tensile stress} * \text{Area} \quad (1)$$

$$\text{Compressive stress } (P_c) = \text{Compressive stress} * \text{Area} \quad (2)$$

Inertia load is another form of load acting on the steering knuckle which is due to the inertia of moving parts. The inertia load can be derived from the following expression in Equations 3 and 4:

$$\text{Inertia load } (F_a) = \omega^2 R \left[ \text{Cos}\theta + \frac{R}{L} \text{Cos}(2\theta) \right] \quad (3)$$

$$\text{Bending load } (F_b) = \frac{\rho A t L \sin(\theta + \phi)}{2} N \quad (4)$$

The force of resistance per unit area, offered by a body against deformation is known as stress. This is given by Equation 5:

$$\text{Stress } (\sigma) = \frac{P}{A} \quad (5)$$

**4TH INTERNATIONAL LATIN AMERICAN  
CONGRESS ON NATURAL AND APPLIED SCIENCES**

Inertia bending load sets up a stress which would be tensile on one side of the steering knuckle and compressive on another side and this changes sign each half revolution (Babu et al., 2014). The bending moment at any section from the small end is given Equation 6:

$$M = \frac{x}{a} \left[ 1 - \frac{x^2}{L^2} \right] \quad (6)$$

The stress could be computed using the following Equation 7:

$$\sigma_B = \frac{M}{z} \quad (7)$$

$$M = \frac{I}{2.5} \times t \quad (8)$$

$$I = 419 * t^4 \quad (9)$$

The steering knuckle is subject to a number of multi-translated loads (lateral and multiaxial forces) which are highlighted as follows:

- i. Load on Hub Bearing
- ii. Steering Moment
- iii. Braking Force

The analysis attempts to investigate the impact of these forces on the model. A static structural analysis was carried out to determine the impact of the several loads and moments on the knuckle. The model was done on SolidWorks 2018 while the analysis was done on ANSYS 2019 R1.

**i. Load on the Hub Bearing**

The load on the Hub is the load of the car, evenly distributed into the four tyres. The load model used for the analysis was 1606 Kg assumed to be dead weight of the car, therefore the total weigh on the knuckle hub was given by  $1606/4 = 401.5Kg$ . The total force on the hub was recorded as (This force acted in the Z direction):

$$401.5 \times 9.81 = 3938.715N.$$

**ii. Steering Moment**

A small steering force of 50N is usually required to turn the steering arm. Therefore, the moment from the force is multiplied by the perpendicular distance of 108mm. The moment was calculated as:

$$50 \times 108 = 5400N.mm$$

**iii. The Braking Force**

The Braking force on the wheel was calculated using Equation 10.

$$F = \frac{mv^2}{2D} \quad (10)$$

Where F is the braking force, m is the mass of vehicle =1606Kg, v is the velocity of vehicle (maximum) = 44.44(160Km/h) and D is the braking distance =100m



**4TH INTERNATIONAL LATIN AMERICAN  
CONGRESS ON NATURAL AND APPLIED SCIENCES**

$$F = \frac{401.5 \times 44.44^2}{2 \times 100} = 3964.63$$

$$\text{Braking moment} = F \times d = 3964.63 \times 70.04 = 277,524.73 \text{ N}\cdot\text{mm}$$

Gravity was enabled to take proper account of inertia. The model loads of the steering knuckle under static condition is shown in Figure 4, while load summary of the steering knuckle model is presented in Table 1.

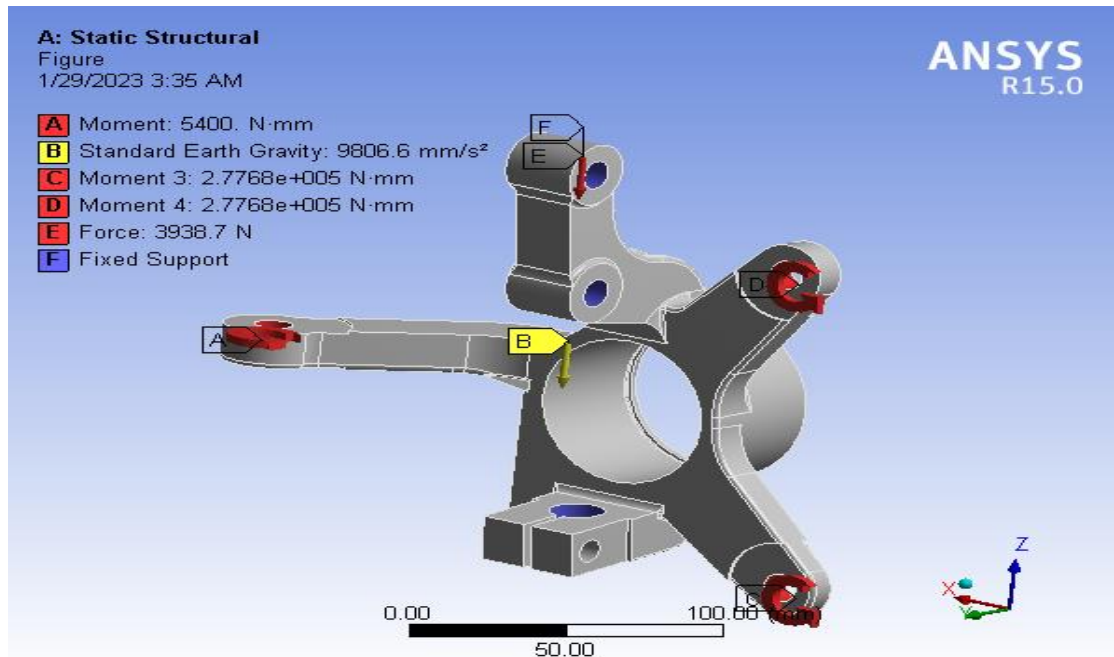


Figure 4: Model loads of the steering knuckle under static condition

Table 1: Load summary of the steering knuckle model

Object Name	Fixed Support	Steering Moment	Braking Moment	Hub Loading
State	Fully Defined	Fully Defined	Fully Defined	Fully Defined
Geometry	3 Faces	1 Face	2 Faces	1 Face
Type	Fixed Support	Moment	Moment	Force
Suppressed	No	No	No	No
Define By		Vector	Vector	Components
Coordinate System				
X Component				
Y Component				
Z Component				-3938.7N (ramped)
Magnitude		5400. N·mm (ramped)	277,524.73 N·mm (ramped)	
Direction		Defined	Defined	



### 3. Results and Discussion

Mechanical failures in automobile are often attributed to wear and tear of two moving parts of a vehicle in contact, poor design or manufacturing defects, lack of proper inspection or maintenance etc (Ikpe et al., 2016a). The analysis of steering knuckle component in this study was done with ANSYS Workbench 15.0. The load applied to the steering knuckle component was determined based on what is obtainable in literature. According to these papers, the average weight of vehicles is assumed to be 1606 kg. This weight is directly applied to all four knuckles, resulting in a weight of 401.5 kg on each wheel. This translates to an average force of 3041.1 N on each wheel, taking into account the acceleration due to gravity. The knuckle is also subject to multi-translated loads (lateral and multiaxial forces) such as braking force, moment, lateral force, and steering force, as well as loads in the X, Y and Z directions. The results of these analyses are presented in Table 2.

Table 2: Results summary of static analysis

Object Name	Equivalent Stress	Total Deformation	Equivalent Elastic Strain	Maximum Principal Stress	Maximum Shear Stress
<b>Scope</b>					
Scoping Method	Geometry Selection				
Geometry	All Bodies				
<b>Definition</b>					
Type	Equivalent (von-Mises) Stress	Total Deformation	Equivalent Elastic Strain	Maximum Principal Stress	Maximum Shear Stress
By	Time				
Display Time	Last				
Calculate Time History	Yes				
Suppressed	No				
<b>Integration Point Results</b>					
Display Option	Averaged		Averaged		
Average Across Bodies	No		No		
<b>Results</b>					
Minimum	1.3995e-004 MPa	0. mm	6.0614e-009 mm/mm	-14.045 MPa	8.0273e-005 MPa
Maximum	36.079 MPa	6.9036e-002 mm	5.0853e-004 mm/mm	45.388 MPa	19.665 MPa
<b>Minimum Value Over Time</b>					
Minimum	1.3995e-004 MPa	0. mm	6.0614e-009 mm/mm	-14.045 MPa	8.0273e-005 MPa
Maximum	1.3995e-004 MPa	0. mm	6.0614e-009 mm/mm	-14.045 MPa	8.0273e-005 MPa
<b>Maximum Value Over Time</b>					

**4TH INTERNATIONAL LATIN AMERICAN  
CONGRESS ON NATURAL AND APPLIED SCIENCES**

Minimum	36.079 MPa	6.9036e-002 mm	5.0853e-004 mm/mm	45.388 MPa	19.665 MPa
Maximum	36.079 MPa	6.9036e-002 mm	5.0853e-004 mm/mm	45.388 MPa	19.665 MPa

Considering the theory of Von-mises failure criterion, material component is said to be in a state of failure if the Von mises stress resulting from the applied force exceeds the material yield strength. However, if the Von-mises stress value is below the material’s yield strength, it the material is believed to possess more strength that can accommodate further forces before it finally yields (Ikpe et al., 2016b; Ikpe and Owunna, 2017). This relates to the theory of material elasticity which state that a given material under loading material can accommodate more loads/forces as long as its elastic limit is not exceeded. Considering maximum Von-mises stresses value (36.079 MPa) obtained for the steering knuckle model in this analysis and yield strength (165 MPa) of the Aluminium alloy A356.0-T employed as the steering knuckle material, the equivalent maximum simulated Von-mises stress obtained for the materials is below the yield strength of the A356.0-T materials, which implies that the component may likely not fail under the applied load and condition of the simulation. The equivalent maximum simulated Von-mises stress profile is shown in Figure 5. This led to a total deformation of 0.069033 mm as shown in Figure 6 as well as directional deformation (Bending along the Z-axis) of 0.010135 mm as shown in Figure 7. This implies that said deformation may not have any catastrophic effect on the steering knuckle component, as there is still room to accommodate additional forces/loads before it finally yields or fails.

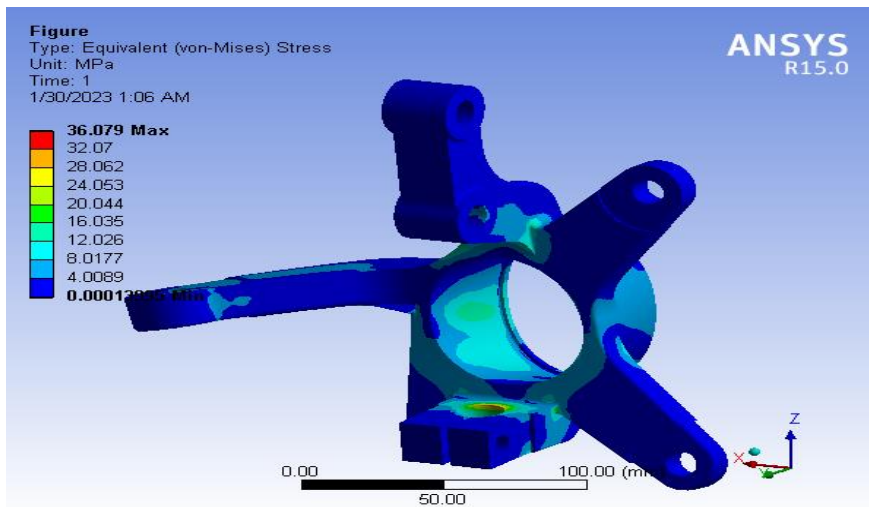


Figure 5: Plot of equivalent Von-mises stress profile

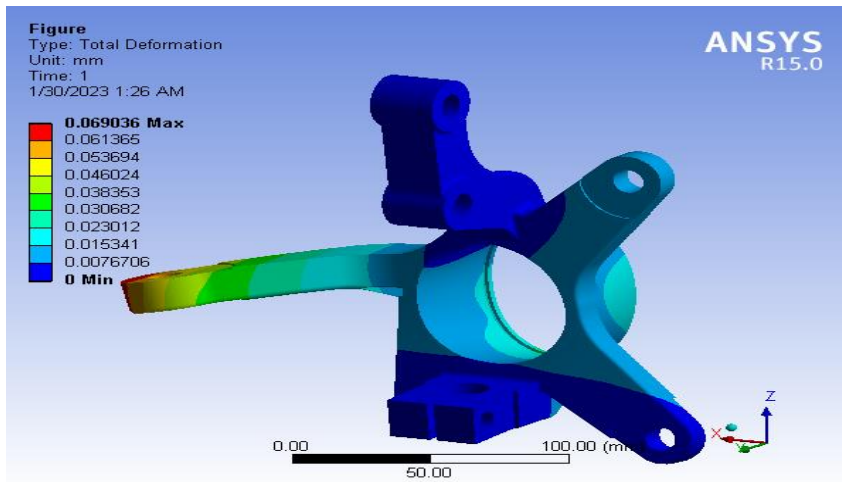


Figure 6: Plot of total deformation profile

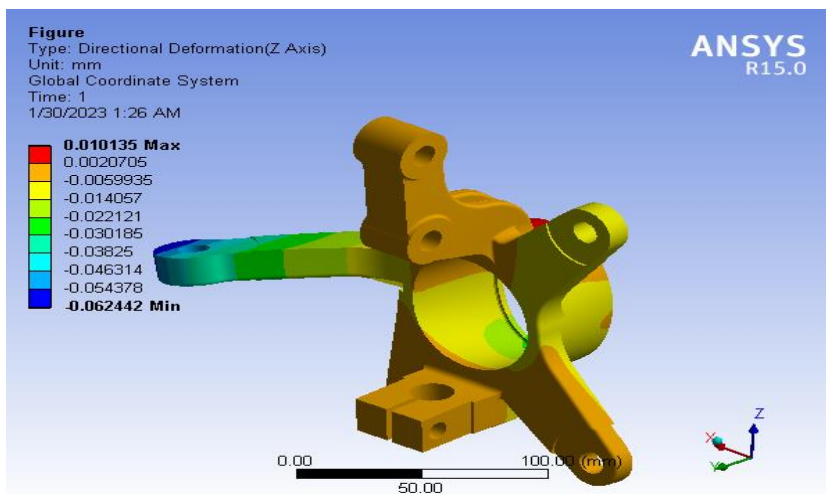


Figure 7: Plot of directional deformation (bending along Z-axis) profile

When the steering knuckle undergoes internal external and external forces due to vibration, steering displacement, temperature, corrosion etc, stress is induced on the material which eventually translates into strain deformation. This is characterized by geometric deformation representing the relative displacement between particles in the material. The said deformation can be considered elongations due to distortion of atoms within the metal lattice, and are dependent on the direction of forces/loads (Etuk et al., 2019). In extreme conditions where the vehicle is exposed to uneven road surfaces characterized by potholes and speed bumps, the steering knuckle may be prone to cyclic loading which induces fluctuating stresses, elastic strains, tensile stresses etc, on the knuckle system that may results in bending deformation and possibly leads to fatigue. The simulated maximum equivalent elastic strain profile is shown in Figure 8. This led to a maximum principal stress ( $\sigma > \sigma > \sigma_{1\ 2\ 3}$ ) of 44.587 MPa as shown in Figure 9, which are stresses corresponding normal stresses acting on the principal planes of zero shear stress. These planes are perpendicular to the principal directions upon which the principal stresses act.

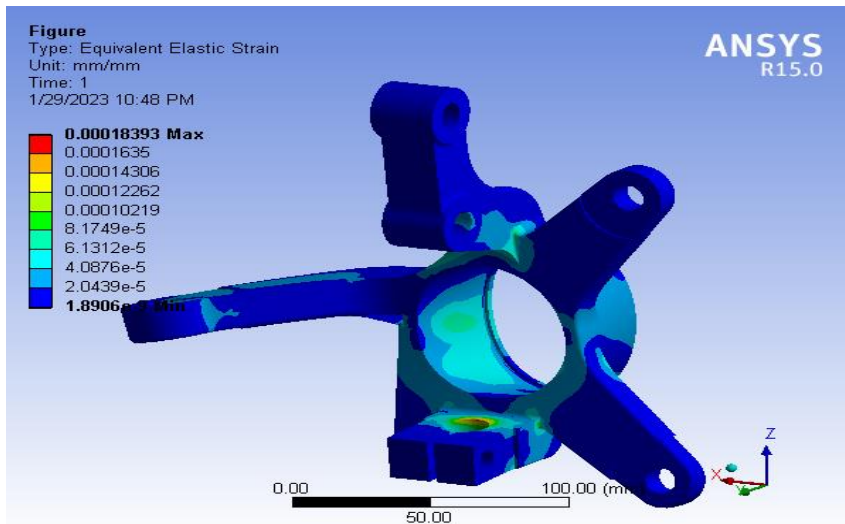


Figure 8: Plot of equivalent elastic strain profile

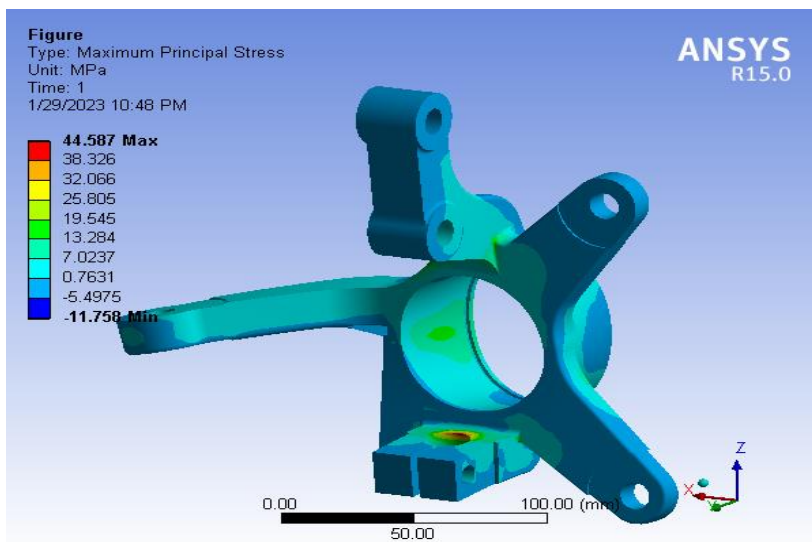


Figure 9: Plot of maximum principal stress profile

Although very insignificant from the beginning, shear stress is induced on the steering knuckle at each cornering cycle made by the steering members, and however tends to be significant after the component might have been exposed to thousands and millions of vibrational and frequency cycle, occasioned by the constant exposure to multi-translated loads (lateral and multiaxial forces) acting on the vehicle suspension system. The simulated maximum shear stress profile as shown in Figure 10 was obtained as 19.871 MPa, which is the load/force per unit area that tends to cause deformation of the steering knuckle by slippage along the planes parallel to imposed stresses.

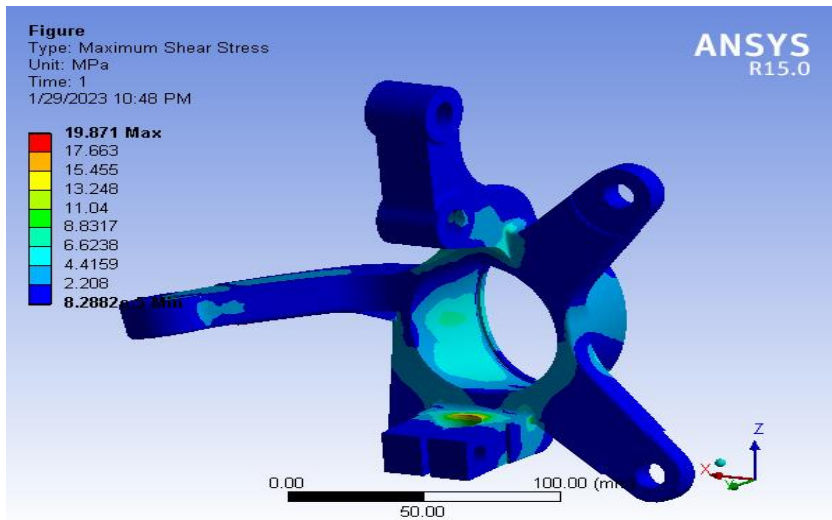


Figure 10: Plot of maximum shear stress profile

Factor of safety plays a vital role in mechanical engineering designs, as users of engineering components oftentimes overload the components beyond their design limit which eventually exposes the component to premature failure during service condition. However, selection of low Factor of Safety (FOS) in engineering design implies that such design may not always meet its design life expectancy due to poor design considerations and low integrity and vice versa (Ikpe and Owunna, 2019). Considering the colour distribution chart on the steering knuckle model shown in Figure 11, royal blue colour is observed to be predominant, followed by lemon colour designated by a value of ten (10) at the mid-section, with little traces of orange colour (with a value of 2.293) at the base. Red colour designated by zero is observed to appear as the least value on the colour profile. Following the colour band on the model, royal blue which has a maximum value of 15 dominates the model, indicating that if FOS of about 15 is selected for the design of a steering knuckle, the final product will have a better quality than when FOS of 10, while steering knuckle designed with FOS of 10 will have a better quality than the same component designed with FOS of 2.293 which happens to be the least on the colour profile in Figure 11. However, it should be noted that a given steering knuckle with higher FOS implies a better quality which comes at a higher cost.

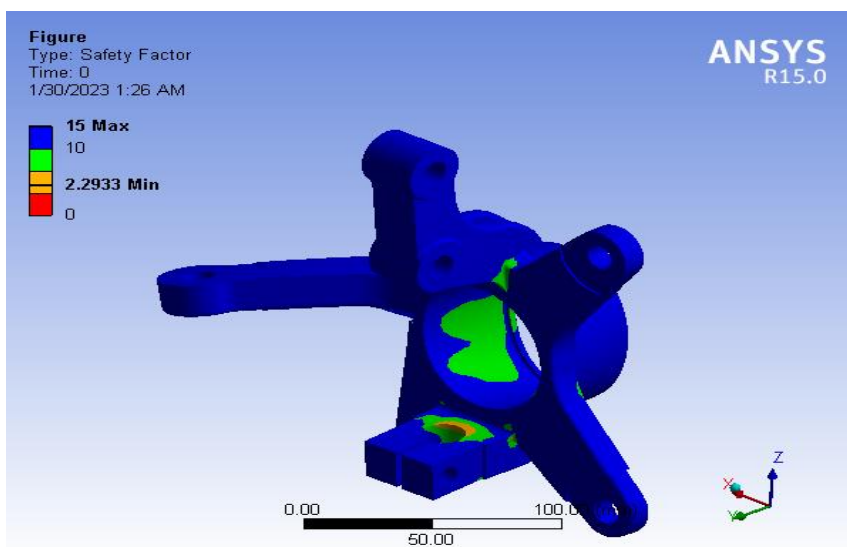


Figure 11: Plot showing factor of safety profile



#### **4. Conclusion**

In this study, multi-axial non-proportional random analysis of a typical hub steering knuckle was successfully conducted with respect to in-service loading (lateral and multi-axial loads) effects on the geometric model. The aluminium alloy A356.0-T6 assigned to the steering knuckle model in this study had mass density of  $2670 \text{ kg/m}^3$  which could provide a reasonable fuel reduction in auto applications. The maximum Von-mises stress was recorded as 36.079 MPa, with maximum principal stress of 45.388 MPa and shear stress of 19.665 MPa. An average FOS of 10 as well as maximum FOS of 15 was obtained in the current state of the analysis. Except at the bottom bolt hole where SOF was just about 2.5. The maximum total deformation of the model is 0.069mm. The directional deformation in the Z-axis indicated the bending of the member under the influence of the applied forces, with maximum bending of 0.06242mm. The maximum Von-mises stress value was observed to be less than the yield strength of Aluminium alloy A356.0-T employed in the analysis, indicating that the steering knuckle model still had the strength to withstand additional forces before yielding. This was due to average value of 10 selected as the FOS which implied that a better material with optimum physical, mechanical and thermal properties was employed which could withstand the in-service loads/forces acting on the steering knuckle during service condition. Moreover, proper boundary conditions well as quality mesh. This was observed to influence the rest of the parameters that were analysed in this study such as the total deformation, directional deformation (bending along Z-axis), equivalent elastic strain, maximum elastic stress as well as the maximum shear stress. Considering the aforementioned findings obtained from this study, the following recommendations could help manufacturers improve the quality of conventional steering knuckle for optimum vehicular performance:

- i. From the colour distribution profiles of the steering knuckle mode, lemon and blue colour represented by a value of 10 and 15 were identified as the average and better FOS. Therefore, manufacturers adopting the analytical conditions presented in this study should aim at a FOS between 10 and 15. On the other hand, while FOS with higher values may incur additional cost, it should be borne in mind that FOS lower than recommended value can compromise the quality and performance of the component during service condition.
- ii. Also, manufacturers should take cognisance of physical, mechanical and thermal properties of materials selected for steering knuckle application, as the longevity of the component even in rough terrains also depend on the material properties.
- iii. Lightweight materials should also be considered for steering knuckle application, as this will provide an ideal fuel saving scenario during service condition of the vehicle.

#### **References**

Babu, B., Prabhu, M., Dharmaraj, P. and Sampath, R. (2014) Stress analysis on steering knuckle of the automobile steering system. *International Journal of Research in Engineering and Technology*, 3(3), 363-366.

Kashyzadeh, K. R. (2023) Failure Strength of Automotive Steering Knuckle Made of Metal Matrix Composite. *Applied Mechanics*, 4, 210-229.

Li, F., Sun, J., Bao, J., Yang, J., Li, H., Zhong, C., Gao, Y., He, Q., Xie, K. and Li, W. (2022) Failure analysis of truck steering knuckle. *Engineering Failure Analysis*, 140, 106537.



**4TH INTERNATIONAL LATIN AMERICAN  
CONGRESS ON NATURAL AND APPLIED SCIENCES**

Dumbre, P., Mishra, A. K., Aher, V. S., and Kulkarni, S. S. (2014) Structural analysis of steering knuckle for weight reduction, International Journal of Advanced Engineering Research Studies, e-ISSN: 2249-8974, 1-4.

Babu, B., Prabhu, M., Dharmaraj, P. and Sampath, R. (2014) Stress Analysis on Steering Knuckle of the Automobile Steering System. International Journal of Research in Engineering and Technology, 3(3), 363-368.

Muhamad, W. M., Sujatmika, E., Hamid, H. and Tarlochan, F. (2012) Design improvement of steering knuckle component using shape optimization. International Journal of Advanced Computer Science, 2(2), 65-69.

Ikpe, A. E. and Owunna, I. B. (2019) Design of Remotely Controlled Hydraulic Bottle Jack for Automobile Applications. International Journal of Engineering Research and Development, 11(1), 124-134.

Sharma, M. P., Mevewala, D. S., Joshi, H. and Patel, D. A. (2014) Static analysis of steering knuckle and its shape optimization. Journal of Mechanical and Civil Engineering, e-ISSN: 2278-1684, 34-38.

Liu, S., Zhang, G. and Wang, A. (2023) Progressive failure mechanism of structuralized cemented slopes. Engineering Failure Analysis, 143, 106939.

Etuk, E. M., Ikpe, A. E. and Azum, U. A. (2019) Modelling and Analysis of 2-Stage Planetary Gear Train for Modular Horizontal Wind Turbine Application. Journal of Applied Research on Industrial Engineering, 6(4) 268-282

Kashyzadeh, K. R. and Farrahi, G. H. (2023) Improvement of HCF life of automotive safety components considering a novel design of wheel alignment based on a Hybrid multibody dynamic, finite element, and data mining techniques. Engineering Failure Analysis, 143, 106932.

Ikpe A. E. and Owunna I. B. (2017) Design of Vehicle Compression Springs for Optimum Performance in their Service Condition. International Journal of Engineering Research in Africa Submitted, 33, 22-34.

Dusane, S. V., Dipke, M. K. and Kumbhalkar, M. A. (2016) Analysis of Steering Knuckle of All Terrain Vehicles (ATV) Using Finite Element Analysis. IOP Conf. Series: Materials Science and Engineering 149 (2016) 012133.

Ikpe, A. E., Owunna, I. B., Ebunilo, P. O. and Ikpe, E. E. (2016a) Static Analysis on a Vehicle Tie Rod to Determine the Resulting Buckling Displacement. International Journal of Industrial and Manufacturing Systems Engineering, 1(1), 16-24

Yadav, S., Mishra, R. K., Ansari, V. and Lal, S. B. (2016) Design and Analysis of Steering Knuckle Component. International Journal of Research and Technology, 5(4), 457-463.

Ikpe A. E. and Owunna I. B. and Ebunilo, P. O. (2016b) Determining the Accuracy of Finite Element Analysis when Compared to Experimental Approach for Measuring Stress and Strain on a Connecting Rod Subjected to Variable Loads. Journal of Robotics, Computer Vision and Graphics, 1(1), 12-20.

**PERFORMANCE ANALYSIS OF SWARM-BASED METAHEURISTIC  
ALGORITHMS ON CONTINUOUS OPTIMIZATION PROBLEMS**

**Dr. Feyza ALTUNBEY ÖZBAY**

Software Engineering, Faculty of Engineering, Firat University  
ORCID NO: 0000-0003-0629-6888

**Dr. Erdal ÖZBAY**

Computer Engineering, Faculty of Engineering, Firat University  
ORCID NO: 0000-0002-9004-4802

**ABSTRACT**

Scientists have drawn creative inspiration from nature for centuries. Swarm intelligence, an essential branch of artificial intelligence, has emerged to simulate the laws of nature and the social behavior of insects or animals. Metaheuristic algorithms are used successfully in wide application areas as they offer potential solutions for complex optimization problems. Metaheuristic algorithms inspired by swarm intelligence have become very popular due to their flexibility and robustness. In recent years, researchers influenced by natural phenomena have proposed many different swarm-based metaheuristic algorithms and applied them to real-world problems in different application fields. In this study, performance analysis of four swarm-based metaheuristic algorithms, namely Harris Hawk Optimization (HHO), Moth Flame Optimization (MFO), Salp Swarm Algorithm (SSA), and Whale Optimization Algorithm (WOA), was performed and the results were comparatively examined. The performances of these algorithms were tested for twelve different benchmark functions in four different types, namely multi-dimension unimodal, fixed-dimension unimodal, multi-dimension multimodal, and fixed-dimension multimodal. The results obtained for the different benchmark functions were analyzed according to the best value, mean value, and standard deviation values. When the results were evaluated, it was seen that the HHO algorithm obtained more promising results for the selected benchmark functions than the other three algorithms. These algorithms and their many different versions can be effectively applied to solve many search and optimization problems.

**Keywords:** swarm intelligence, optimization, continuous optimization problem.

**1. INTRODUCTION**

Optimization is the process of finding the most suitable solution for a problem among potential solutions. Since real-world optimization problems have become difficult, it has required the development of more effective solution methods. Some of the researchers use classical optimization methods to solve these optimization problems. In many optimization problems, classical optimization is insufficient. For this reason, metaheuristic optimization algorithms have been proposed. With the advancement of science, the need for metaheuristic optimization algorithms in different application areas is increasing. The increase in data volume in real-world problems makes it difficult to solve problems. Metaheuristic optimization algorithms are used to solve NP-hard problems, which are a set of optimization problems that cannot be solved in a polynomial at a time [1]. These algorithms provide optimal or near-optimal solutions for NP-hard problems in an acceptable time. Metaheuristic

optimization algorithms have many advantages: i) They do not need gradient information. ii) They do not require knowledge of the characteristics of the search space and are independent of the problem. iii) They have a strong search capability [2]. Therefore, these algorithms are effectively used for solving many different real-world problems, for example; fake news detection [3], feature selection [4], social network analysis [5], medical diagnosis [6, 7], parameter optimization [8, 9], etc.

Metaheuristic optimization algorithms, whose efficiency has been verified in many areas, are examined in 3 different classes: evolution-based, physics-based, and swarm-based algorithms. Evolution-based algorithms are inspired by the laws of evolution in nature. Genetic Algorithm [10], Differential Evolution [11], and Evolutionary Strategy [12] are the most well-known of these evolutionary-based algorithms. Physics-based algorithms are metaheuristic algorithms inspired by the laws of physics. In the literature, there are many algorithms inspired by different laws of physics: Tabu Search [13], Big-Bang Big-Crunch [14], Gravitational Search Algorithm [15], Water Cycle Algorithm [16], Ray Optimization [17], and so on. The inspiration for swarm-based algorithms is the social behavior of different species in nature. The best-known swarm-based algorithms are Particle Swarm Optimization (PSO) [18] and the Ant Colony Optimization (ACO) [19] algorithm. PSO was proposed inspired by the movement of flocks of birds. ACO mathematically modeled the ants' search for the shortest path to reach the food source. Grey Wolf Optimizer [20], Tunicate Swarm Algorithm [21], Grasshopper Optimization Algorithm [22], Elephant Herding Optimization [23], Manta Ray Foraging Optimization [24], Artificial Bee Colony [25], Firefly Algorithm [26], Butterfly Optimization Algorithm [27], and Krill Herd Algorithm [28] are the other algorithms based on swarm intelligence.

In this study, performance evaluation of Harris Hawk Optimization (HHO), Moth Flame Optimization (MFO), Salp Swarm Algorithm (SSA) and Whale Optimization Algorithm (WOA) algorithms has been performed. Twelve benchmark functions of four different types were used to analyze the efficiency of the algorithms. The results obtained with the four algorithms examined were compared in terms of best, average, and standard deviation values. At the same time, the convergence curves obtained by the algorithms for these continuous functions are also examined.

The remainder of the article is organized as follows. HHO, MFO, SSA, and WOA are discussed in detail in the second part. In the third chapter, information about twelve continuous optimization problems is given and the results obtained with algorithms based on swarm intelligence are analyzed comparatively. Finally, the results are given in the fourth section.

## **2. BACKGROUND OF THE ALGORITHMS**

### **2.1. Harris Hawk Optimization (HHO) Algorithm**

The HHO algorithm is modeled inspired by the hunting, exploring, and attack strategies of Harris hawks. Since HHO is a population-based, gradient-free technique, it can be applied to any optimization problem with an appropriate formulation [29].

The Harris hawks are the candidate solutions in HHO, and in each stage, the best candidate solution is taken into account as the intended prey or nearly the best. The Harris hawks in HHO perch haphazardly in certain places and wait to spot prey using two different techniques. They perch based on the positions of other family members (to be close to them when attacking) and the rabbit, which is modeled in Eq. (1) for the condition of  $q < 0.5$ , or perch on random tall trees (random locations inside the group's home range), which is modeled in Eq. (1) for the condition of  $q \geq 0.5$ . This is true if we assume an equal chance  $q$  for each perching strategy [29].

$$X(t + 1) = \begin{cases} X_{rand}(t) - r_1 |X_{rand}(t) - 2r_2 X(t)| & q \geq 0.5 \\ (X_{rabbit}(t) - X_m(t)) - r_3(LB + r_4(UB - LB)) & q < 0.5 \end{cases} \quad (1)$$

where  $X(t + 1)$  indicates the position vector of hawks with the next iteration  $t$ ,  $X_{rabbit}(t)$  refers to the rabbit position,  $X(t)$  is the current position vector of hawks. Random numbers inside of  $(0,1)$ ,  $r_1$ ,  $r_2$ ,  $r_3$ ,  $r_4$ , and  $q$  are updated after each iteration. The variables' upper and lower bounds are displayed in  $LB$  and  $UB$ . The hawk named  $X_{rand}(t)$  was chosen at random from the present population and  $X_m$  is the average location of the current hawk population. Eq. (2) determines the hawks' average position [29]:

$$X_m(t) = \frac{1}{N} \sum_{i=1}^N X_i(t) \quad (2)$$

here  $N$  is the total number of hawks and  $X_i(t)$  represents the locations of each hawk in iteration  $t$ . The escape behavior of a prey causes a significant loss of energy. This fact is represented by Eq. (3) with the following model of prey energy [29].

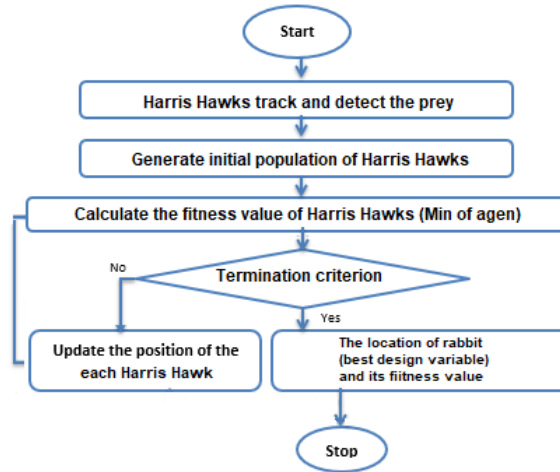
$$E = 2E_0(1 - \frac{t}{T}) \quad (3)$$

The prey always tries to get away from dangerous circumstances. Assume that  $r$  represents the likelihood of the prey fleeing successfully ( $r < 0.5$ ) or failing to escape successfully ( $r \geq 0.5$ ) prior to the surprise pounce. The rabbit still has enough energy when  $r \geq 0.5$  and  $|E| \geq 0.5$ , and it tries to flee by making a series of erroneous hops, but ultimately is unable to. This Harris hawks attempt is modeled by Eq. (4) and (5):

$$X(t + 1) = \Delta X(t) - E |J X_{rabbit}(t) - X(t)| \quad (4)$$

$$\Delta X(t) = X_{rabbit}(t) - X(t) \quad (5)$$

here  $J = 2(1 - r_5)$  is the rabbit's random leap strength during the fleeing process,  $r_5$  is a random value inside  $(0,1)$ , and  $\Delta X(t)$  is the difference between the rabbit's position vector and the current location in iteration  $t$ . To mimic the nature of rabbit locomotion, the  $J$  value fluctuates at random during each repetition. The flowchart of the HHO algorithm is represented as in Fig 1.



**Fig. 1.** The HHO algorithm flowchart

## 2.2. Moth-Flame Optimization (MFO) Algorithm

Moths are elegant insects that closely resemble the butterfly family. The most intriguing aspect of moths is their unique nighttime navigational strategies. They have evolved to use moonlight to fly at night. For navigation, they used a technique known as transverse orientation. The candidate solutions in the proposed MFO method are assumed to be moths, and the variables in the problem are the locations of the moths in the space. The population-based nature of the MFO method requires that the set of moths be represented in a matrix as in Eq. (6) [30]:

$$M = \begin{bmatrix} m_{1,1} & m_{1,2} & \cdots & \cdots & m_{1,d} \\ \vdots & \vdots & \vdots & \vdots & \vdots \\ m_{n,1} & m_{n,2} & \cdots & \cdots & m_{n,d} \end{bmatrix} \quad (6)$$

here  $d$  is the quantity of variables and  $n$  is the number of moths (dimension). The MFO algorithm, which approximates the global optimal of the optimization problems, is defined as a three-tuple in Eq. (7):

$$MFO = (I, P, T) \quad (7)$$

A random population of moths and accompanying fitness values are generated by the  $I$  function. The moths are moved around the search area via the  $P$  function. When the termination requirement is satisfied, the  $T$  function returns true; otherwise, it returns false. Using Eq. (8), each moth's position in relation to a flame is updated after initialization [30].

$$M_i = S(M_i, F_j) \quad (8)$$

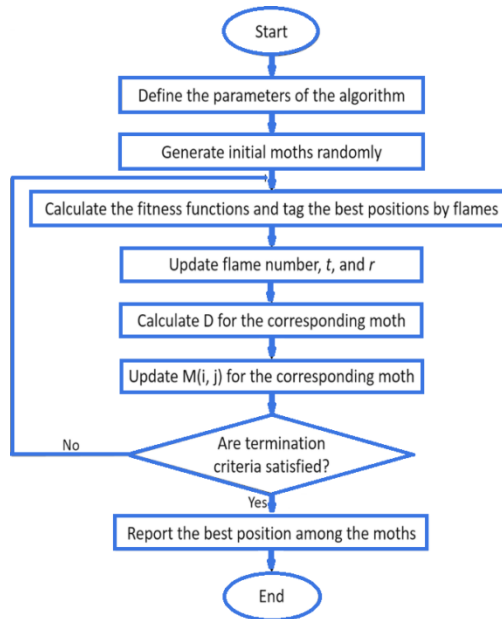
here, the spiral function is denoted by  $S$ , the  $j$ th flame is denoted by  $F_j$ , and the  $i$ th moth is denoted by  $M_i$ . The MFO algorithm's definition of a logarithmic spiral is as follow in Eq. (9):

$$S(M_i, F_j) = D_i \cdot e^{bt} \cdot \cos(2\pi t) + F_j \quad (9)$$

$D$  is calculated in Eq. (10):

$$D_i = |F_j - M_i| \quad (10)$$

here  $M_i$  defines the  $i$ th moth,  $F_j$  for the  $j$ th flame, and  $D_i$  for the  $i$ th moth's distance from the  $j$ th flame. The flowchart of the MFO algorithm is represented as in Fig 2.



**Fig. 2.** The MFO algorithm flowchart

### 2.3. Salp Swarm Algorithm (SSA)

The Salp Swarm Optimization Algorithm, often known as SSA, is a meta-heuristic optimization technique developed by Mirjalili et al. in 2017. It is based on the salps' swarming behavior when foraging in the water. While searching for food, the salps create linear or circular colonies that are headed by the salp at the front; this salp is the leader salp, and the others are the followers. Firstly, by solving the following equation, the leader Salp could alter his position. The SSO algorithm converts this mechanism into a mathematical model using Eq. (11) [31]:

$$X_1^i = \begin{cases} A^i + r_1((X_{max}^i - X_{min}^i)r_2 + X_{min}^i) & r_3 \geq 0 \\ A^i - r_1((X_{max}^i - X_{min}^i)r_2 + X_{min}^i) & r_3 < 0 \end{cases} \quad (11)$$

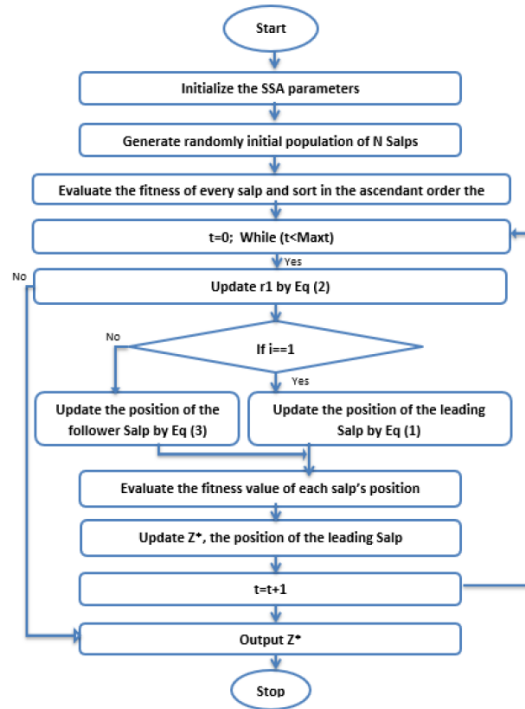
$$i = 1, 2, \dots, D; r_1 = 2e^{-\frac{4 \cdot iter}{\max\_iter}} \quad (12)$$

Two random numbers between 0 and 1 are  $r_2$  and  $r_3$ . The problem dimension is defined with  $D$ . An SSA coefficient called  $r_1$  enables the balancing of the exploitation and exploration processes. The extrema of the  $i$ th dimension of the solution space are  $X_{min}^i$  and  $X_{max}^i$ .  $X_1^i$  is the  $i$ th dimension of the leader salp location,  $A^i$  is the  $i$ th dimension of the prey position. Eq. (13) is used to modify the position of the follower [31].

$$X_m^i = \frac{1}{2}(X_m^i + X_{m-1}^i), \quad m = 1, 2, \dots, N \quad (13)$$

here  $N$  is the total number of salps, and  $X_m^i$  and  $X_{m-1}^i$  are the locations of two neighboring salps. The SSO algorithm's flowchart is shown in Fig 3.





**Fig. 3.** The SSA algorithm flowchart

#### 2.4. Whale Optimization Algorithm (WOA)

A meta-heuristics algorithm WOA is suggested by Mirjalili and Lewis (2016) introduced this approach for optimizing numerical issues. WOA was particularly influenced by the social interactions and bubble-net hunting of humpback whales in the ocean. The mathematical model of the WOA algorithm, inspired by the social interactions and hunting techniques of humpback whales in the oceans, is expressed as follows [32].

Based on the positions of each agent, the search agent (humpback whale) randomly seeks out the optimal solution (the prey). Rather than the best search agent, we use a random search agent to update the position of a search agent throughout this phase. The search agent will subsequently be forced to move away from a reference whale if  $|A| > 1$ , as determined by Eq. (16). The mathematical framework for this phase is as follows [32]:

$$\vec{D} = |\vec{C} * \overrightarrow{X_{rand}} - \vec{X}| \quad (14)$$

$$\vec{X}(t + 1) = \overrightarrow{X_{rand}} - \vec{A} * \vec{D} \quad (15)$$

here  $\vec{A}$  and  $\vec{C}$  are coefficient vectors, and  $\overrightarrow{X_{rand}}$  is a randomly chosen position vector drawn from the current population. Moreover, the equations of  $\vec{A}$  and  $\vec{C}$  that can be utilized to determine the ideal search agents are as follows:

$$\vec{A} = 2 * \vec{a} * \vec{r} - \vec{a} \quad (16)$$

$$\vec{C} = 2 * \vec{r} \quad (17)$$

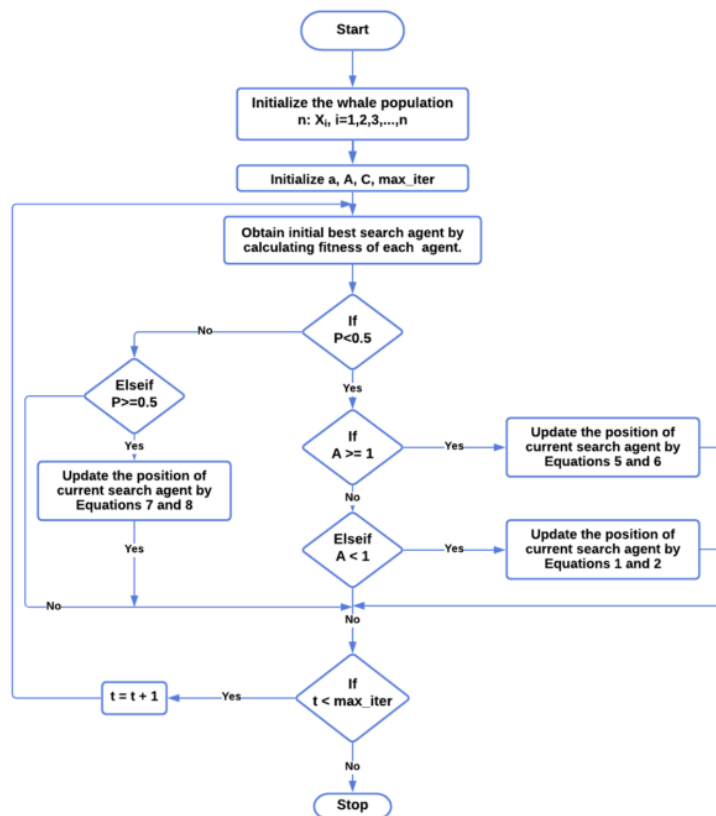
here  $\vec{a}$  drops linearly from 2 to 0 over the course of iterations, and  $\vec{r}$  is a random vector with a range of [0, 1].

$$\vec{X}(t + 1) = \vec{X}'(t) - \vec{A} * \vec{D} \tag{18}$$

here  $t$  denotes the current iteration,  $\vec{X}$  is a solution's position vector,  $\vec{A}$  and  $\vec{C}$  denote coefficient vectors, and  $\vec{X}'$  denotes the location of the best solution, as indicated in Eq. (16) and Eq. (17). In the second phase the following mathematical equations define the helix-shaped movement of humpback whales to define the position between whale and prey [32]:

$$\vec{X}(t + 1) = \begin{cases} \vec{X}'(t) - \vec{A} * \vec{D} & \text{if } p < 0.5 \\ \vec{D}'' * e^{bl} * \cos(2\pi l) + \vec{X}' & \text{if } p \geq 0.5 \end{cases} \tag{19}$$

here  $l$  is a random value between  $[-1, 1]$ ,  $b$  is a constant defining the shape of the logarithmic spiral, and  $\vec{D}'' = |\vec{X}'(t) - \vec{X}(t)|$  indicates the distance between the whale and the prey (best solution so far). The mathematical model that explains how humpback whales move in a spiral-shaped pattern while also swimming in a diminishing circle around their prey is as follows. The likelihood of using any of these two approaches to update the positions of whales is represented by the number  $p$ . We assume that there is a 50% chance that one of the two strategies will be chosen.  $p$  is then a random number between  $[0, 1]$ . Fig. 4 displays the flowchart of the WOA algorithm.



**Fig. 4.** The WOA algorithm flowchart

### 3. EXPERIMENTAL RESULTS

In this section, the results obtained with HHO, MFO, SSA, and WOA, the details of the benchmark functions, the parameters of four different optimization algorithms, and their values are examined. To evaluate the performance of HHO, MFO, SSA, and WOA, twelve

**4TH INTERNATIONAL LATIN AMERICAN  
CONGRESS ON NATURAL AND APPLIED SCIENCES**

different benchmark functions including multi-dimension unimodal, fixed-dimension unimodal, multi-dimension multimodal, and fixed-dimension multimodal functions were used. The properties of the benchmark functions are given in Table 1. In Table 1, the dim column represents the dimension of the benchmark function. The range shows the lower and upper bounds. Moreover, the optimum column represents the optimal global value. The benchmark functions in Table 1 are minimization problems and are divided into four different groups.  $f_1$ - $f_3$  functions are multi-dimensional unimodal functions.  $f_4$ - $f_6$  functions are fixed-dimension unimodal functions.  $f_7$ - $f_9$  functions are multi-dimensional multimodal and  $f_{10}$ - $f_{12}$  functions are fixed-dimension multimodal functions.

**Table 1.** The details of benchmark functions

<b>Multi-dimension unimodal benchmark problems</b>				
<b>Name</b>	<b>Equation</b>	<b>Dim</b>	<b>Range</b>	<b>Optimum</b>
Zakharov	$f_1(x) = \sum_{i=1}^D x_i^2 + \left(\sum_{i=1}^D 0.5ix_i\right)^2 + \left(\sum_{i=1}^D 0.5ix_i\right)^4$	30	[-5,10]	0
Rosenbrock	$f_2(x) = \sum_{i=1}^D [100(x_i + 1 - x_i^2)^2 + (x_i - 1)^2]$	30	[-30,30]	0
Step	$f_3(x) = \sum_{i=1}^D (x_i + 0.5)^2$	30	[-100,100]	0
<b>Fixed-dimension unimodal benchmark problems</b>				
Trid	$f_4(x) = \sum_{i=1}^D (x_i^2 - 1)^2 - \sum_{i=2}^D x_i x_i - 1$	10	[-100,100]	-210
Dixon-price	$f_5(x) = (x_1 - 1)^2 + \sum_{i=2}^D i(2x_i^2 - x_{i-1})^2$	2	[-10,10]	0
Booth	$f_6(x) = (x_1 + 2x_2 - 7)^2 + (2x_1 + x_2 - 5)^2$	2	[-10,10]	0
<b>Multi-dimension multimodal benchmark problems</b>				
Griewank	$f_7(x) = 1 + \sum_{i=1}^D \frac{x_i^2}{4000} - \prod_{i=1}^D \cos\left(\frac{x_i}{\sqrt{i}}\right)$	30	[-600,600]	0
Langermann	$f_8(x) = \sum_{i=1}^5 c_i \exp\left(\frac{-1}{\pi} \sum_{j=1}^D (x_j - A_{ij})^2\right) \cos\left(\pi \sum_{j=1}^D (x_j - A_{ij})^2\right)$			
Schwefel	$f_9(x) = -\frac{1}{D} \sum_{i=1}^5 x_i \sin(\sqrt{ x_i })$	30	[-500,500]	-12,569.5
<b>Fixed-dimension multimodal benchmark problems</b>				
Goldstein price	$f_{10}(x) = [1 + (x_1 + x_2 + 1)^2(19 - 14x_1 + 3x_1^2 - 14x_2 + 6x_1x_2 + 3x_2^2)][30 + (2x_1 - 3x_2)^2(18 - 32x_1 + 12x_1^2 + 4x_2 - 36x_1x_2 + 27x_2^2)]$	2	[-2,2]	3
Styblinski tank	$f_{11} = \frac{1}{2} \sum_{i=1}^D (x_i^4 - 16x_i^2 + 5x_i)$	10	[-5,5]	-391.66

**4TH INTERNATIONAL LATIN AMERICAN  
CONGRESS ON NATURAL AND APPLIED SCIENCES**

Holder table	$f_{12}(x) = -\left  \sin(x_1)\cos(y_1)\exp\left(1 - \frac{\sqrt{x_1^2 + x_2^2}}{\pi}\right) \right $	2	[-10,10]	-19.208
--------------	---	---	----------	---------

In order to make a fair evaluation, these algorithms were applied to twelve benchmark functions under the same conditions. The number of populations and the maximum number of iterations were set as 30 and 500, respectively. Each of the four swarm intelligence-based optimization algorithms were run independently for each benchmark function 30 times. The control parameters of HHO, MFO, SSA, and WOA are shown in Table 2.

**Table 2.** The parameter setting

Algorithms	Parameter
HHO	$\beta = 1.5$
MFO	$b = 1$
SSA	$c_2$ and $c_3$ random numbers between [0,1]
WOA	$a = [0,2]$ $b = 1$

The best, mean and standard deviation values obtained from these algorithms are given in Table 3. Rank values in the table are calculated according to the average value obtained from the algorithms. Total rank represents the performance of HHO, MFO, SSA, and WOA relative to the average value. While the total rank value of the algorithm that achieves the best value for the comparison function is 1, the rank of the algorithm that gives the worst value is 4. The total rank values of the remaining algorithms are between 1 and 4. According to Table 3, in the  $f_1$ ,  $f_2$ ,  $f_4$ ,  $f_7$ ,  $f_9$ , and  $f_{11}$  functions, the HHO algorithm achieved better results than MFO, SSA, and WOA. The MFO algorithm obtained the best value for  $f_5$ ,  $f_8$ ,  $f_{10}$ , and  $f_{12}$  functions. The best value for  $f_3$  and  $f_6$  functions have been obtained with SSA. In twelve benchmark functions, 6 times HHO, 4 times MFO, and 2 times SSA obtained the best values as seen in table 3. According to the values in the table, the sum rank value of the HHO algorithm is better than the other three algorithms. For this reason, it has the best total rank value. According to this table, WOA has the worst rank. It is also seen that the total rank values of MFO and SSA are the same.

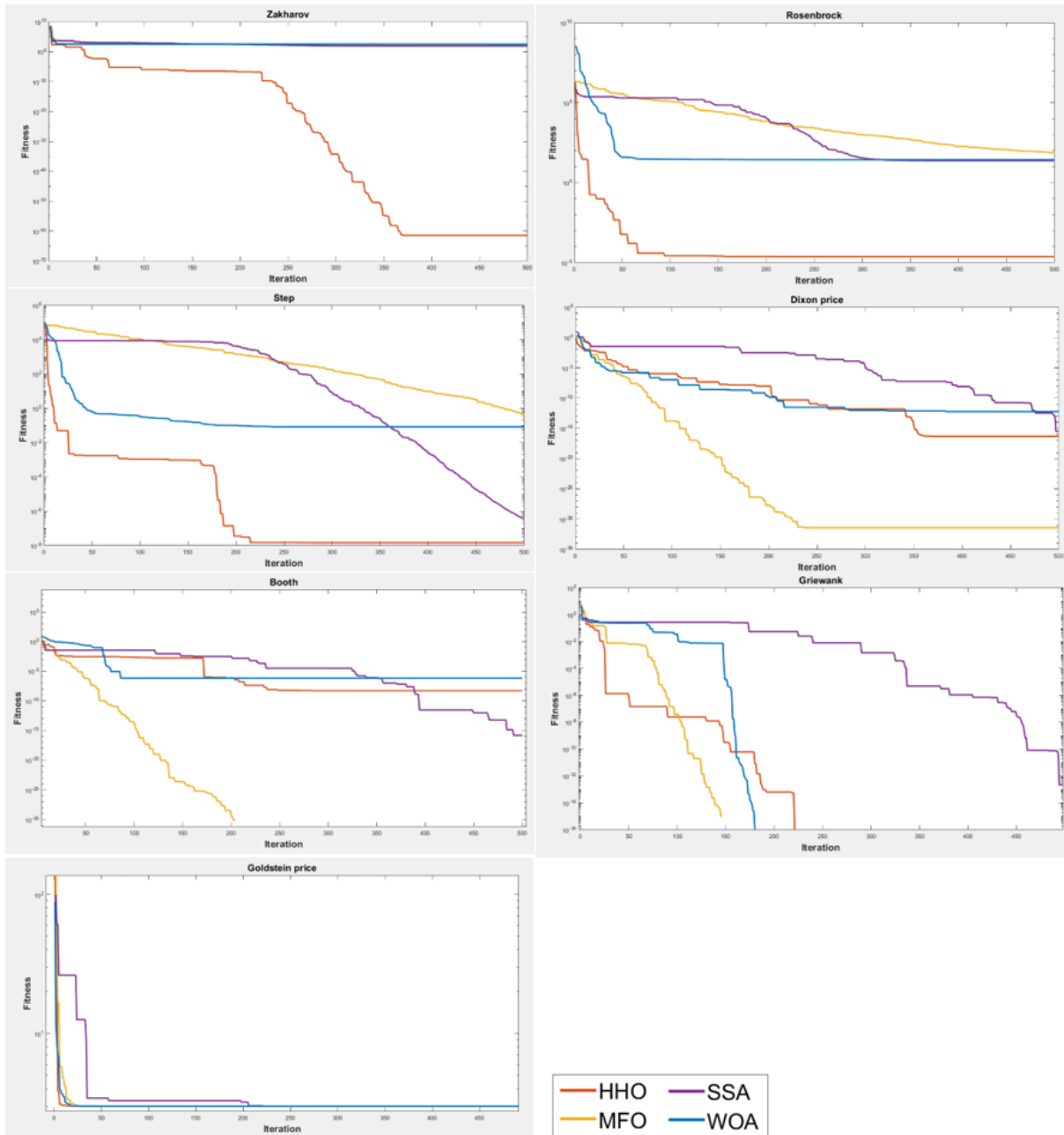
The convergence curves obtained with HHO, MFO, SSA, and WOA for the seven benchmark functions are given in Fig. 5.

**Table 3.** Comparison of results obtained with HHO, MFO, SSA, and WOA for benchmark functions

No.		HHO	MFO	SSA	WOA
F1	Best	3.85E-62	1.44E+02	6.33E+01	2.85E+02
	Mean	3.32E-38	2.33E+02	8.24E+01	3.93E+02
	Std.	1.82E-37	4.02E+01	1.63E+01	4.63E+01
	Rank	1	3	2	4
F2	Best	2.38E-05	7.09E+01	2.34E+01	2.69E+01
	Mean	5.96E-04	4.58E+03	4.44E+01	2.75E+01
	Std.	4.34E-04	1.13E+04	2.85E+01	2.48E-01
	Rank	1	4	3	2
F3	Best	1.47E-08	3.49E-01	3.66E-07	8.20E-02
	Mean	1.29E-05	1.23E+00	2.40E-06	1.87E-01

**4TH INTERNATIONAL LATIN AMERICAN  
CONGRESS ON NATURAL AND APPLIED SCIENCES**

	Std.	1.17E-05	4.52E-01	7.14E-06	5.28E-02
	Rank	2	4	1	3
F4	Best	-210	-209.99	-209.504	-209.989
	Mean	-210	-209.87	-208.093	-209.678
	Std.	3.50E-07	1.24E-01	2.50E+00	3.39E-01
	Rank	1	2	4	3
F5	Best	4.75E-17	3.70E-32	2.99E-16	5.80E-13
	Mean	2.67E-11	3.70E-32	7.71E-14	2.25E-10
	Std.	3.25E-11	0.00E+00	8.89E-14	2.46E-10
	Rank	3	1	2	4
F6	Best	4.83E-09	0.00E+00	1.45E-16	6.40E-07
	Mean	1.96E-06	0.00E+00	5.32E-14	1.37E-04
	Std.	1.78E-06	0.00E+00	5.44E-14	8.95E-05
	Rank	2	4	1	3
F7	Best	0.00E+00	0.00E+00	2.21E-13	0.00E+00
	Mean	0.00E+00	4.68E-03	9.58E-12	1.23E-03
	Std.	0.00E+00	3.63E-03	1.05E-11	2.80E-03
	Rank	1	4	2	3
F8	Best	-4.16E+00	-4.16E+00	-4.16E+00	-4.16E+00
	Mean	-4.14E+00	-4.15E+00	-4.13E+00	-4.14E+00
	Std.	1.42E-02	7.16E-03	2.26E-02	1.22E-02
	Rank	2	1	4	2
F9	Best	-11731.5	-9645.32	-8545.25	-11731.2
	Mean	-11656.6	-8612.49	-7439.24	-11204.3
	Std.	2.38E+02	4.35E+02	4.44E+02	5.58E+02
	Rank	1	3	4	2
F10	Best	3.00E+00	3.00E+00	3.00E+00	3.00E+00
	Mean	3.00E+00	3.00E+00	3.00E+00	3.00E+00
	Std.	6.40E-11	1.89E-15	2.86E-14	7.31E-07
	Rank	3	1	2	3
F11	Best	-391.662	-391.662	-391.662	-391.66
	Mean	-391.662	-379.41	-353.493	-391.635
	Std.	1.13E-04	8.89E+00	2.49E+01	1.63E-02
	Rank	1	3	4	2
F12	Best	-19.2085	-19.2085	-19.2085	-19.2085
	Mean	-19.2085	-19.2085	-19.2085	-19.2085
	Std.	2.13E-12	8.47E-15	1.56E-14	2.11E-08
	Rank	3	1	2	4
Sum Rank		21	31	31	35
Total Rank		1	2	2	3



**Fig. 5.** Converge curve of competitive swarm-based metaheuristic algorithms

#### 4. CONCLUSIONS

In parallel with the developments in computer science, many different metaheuristic optimization algorithms have been proposed for the solution of complex optimization problems. In order to overcome the disadvantages of classical optimization methods, there are many metaheuristic optimization algorithms inspired by the events in nature. In this study, the performance of four different swarm-based metaheuristic algorithms (HHO, MFO, SSA, and WOA) that have been proposed, inspired by the feeding, hunting, and movement behavior of living creatures in nature, was evaluated. Twelve different benchmark functions of four different types (multi-dimension unimodal, fixed-dimension unimodal, multi-dimension multimodal, and fixed-dimension multimodal) were used to evaluate the effectiveness of these



**4TH INTERNATIONAL LATIN AMERICAN  
CONGRESS ON NATURAL AND APPLIED SCIENCES**

algorithms. The results obtained for the twelve different functions with HHO, MFO, SSA, and WOA were analyzed according to the best value, mean value, and standard deviation values. Experimental results show that it achieves better performance with HHO than other algorithms.

The hybrid algorithms can be proposed by combining the advantage of the swarm-based optimization algorithms used in this study with different algorithms. Different versions of each algorithm can be developed to solve different optimization problems.

## REFERENCES

- [1] Muazu, A. A., Hashim, A. S., & Sarlan, A. (2022). Review of Nature Inspired Metaheuristic Algorithm Selection for Combinatorial t-way Testing. *IEEE Access*.
- [2] Ozbay, F. A., & Alatas, B. (2019). A novel approach for detection of fake news on social media using metaheuristic optimization algorithms. *Elektronika ir Elektrotechnika*, 25(4), 62-67.
- [3] Ozbay, F. A., & Alatas, B. (2021). Adaptive Salp swarm optimization algorithms with inertia weights for novel fake news detection model in online social media. *Multimedia Tools and Applications*, 80(26-27), 34333-34357.
- [4] Özbay, F. A., & Özbay, E. (2023). A new approach for gender detection from voice data: feature selection with optimization methods. *J. Fac. Eng. Archit. Gazi Univ.*, 38(2), 1179-1192.
- [5] Altunbey, F., & Alatas, B. (2015). Overlapping community detection in social networks using parliamentary optimization algorithm. *International Journal of Computer Networks and Applications*, 2(1), 12-19.
- [6] Özbay, E. (2022). An active deep learning method for diabetic retinopathy detection in segmented fundus images using artificial bee colony algorithm. *Artificial Intelligence Review*, 1-28.
- [7] Abu Khurmaa, R., Aljarah, I., & Sharieh, A. (2021). An intelligent feature selection approach based on moth flame optimization for medical diagnosis. *Neural Computing and Applications*, 33, 7165-7204.
- [8] Abdel-Basset, M., Mohamed, R., Chakraborty, R. K., Sallam, K., & Ryan, M. J. (2021). An efficient teaching-learning-based optimization algorithm for parameters identification of photovoltaic models: Analysis and validations. *Energy Conversion and Management*, 227, 113614.
- [9] Hao, Q., Zhou, Z., Wei, Z., & Chen, G. (2020). Parameters identification of photovoltaic models using a multi-strategy success-history-based adaptive differential evolution. *IEEE Access*, 8, 35979-35994.
- [10] Holland, J. H. (1992). Genetic algorithms. *Scientific american*, 267(1), 66-73.
- [11] Storn, R., & Price, K. (1997). Differential evolution—a simple and efficient heuristic for global optimization over continuous spaces. *Journal of global optimization*, 11(4), 341.
- [12] Rechenberg, I. (1978). *Evolutionstrategie 1 lab course*. Berlin, Springer, Heidelberg, ISBN 978-3-642-69542-1.
- [13] Glover, F. (1989). Tabu search—part I. *Inform Journal on Computing*, 1(3), 190–206
- [14] Erol, O. K., & Eksin, I. (2006). A new optimization method: Big bang– big crunch. *Advances in Engineering Software*, 37(2), 106–111.
- [15] Wang Y, Gao S, Yu Y, Wang Z, Cheng J, Yuki T (2020) A gravitational search algorithm with chaotic neural oscillators. *IEEE Access* 8:25938–25948
- [16] Eskandar, H., Sadollah, A., Bahreininejad, A., & Hamdi, M. (2012). Water cycle algorithm—A novel metaheuristic optimization method for solving constrained engineering optimization problems. *Computers & Structures*, 110, 151-166.

**4TH INTERNATIONAL LATIN AMERICAN  
CONGRESS ON NATURAL AND APPLIED SCIENCES**

- [17] Kaveh, A., Khayatazad, M. "A new meta-heuristic method: Ray Optimization", *Computers & Structures*, 112–113, pp. 283–294, 2012.
- [18] Kennedy, J., & Eberhart, R. (1995, November). Particle swarm optimization. In *Proceedings of ICNN'95-international conference on neural networks* (Vol. 4, pp. 1942-1948). IEEE.
- [19] Dorigo, M., & Di Caro, G. (1999, July). Ant colony optimization: a new meta-heuristic. In *Proceedings of the 1999 congress on evolutionary computation-CEC99* (Cat. No. 99TH8406) (Vol. 2, pp. 1470-1477). IEEE.
- [20] Mirjalili, S., Mirjalili, S. M., & Lewis, A. (2014). Grey wolf optimizer. *Advances in engineering software*, 69, 46-61.
- [21] Kaur, S., Awasthi, L. K., Sangal, A. L., & Dhiman, G. (2020). Tunicate Swarm Algorithm: A new bio-inspired based metaheuristic paradigm for global optimization. *Engineering Applications of Artificial Intelligence*, 90, 103541.
- [22] Meraihi, Y., Gabis, A. B., Mirjalili, S., & Ramdane-Cherif, A. (2021). Grasshopper optimization algorithm: theory, variants, and applications. *Ieee Access*, 9, 50001-50024.
- [23] Wang, G. G., Deb, S., & Coelho, L. D. S. (2015, December). Elephant herding optimization. In *2015 3rd international symposium on computational and business intelligence (ISCBI)* (pp. 1-5). IEEE.
- [24] Zhao, W., Zhang, Z., & Wang, L. (2020). Manta ray foraging optimization: An effective bio-inspired optimizer for engineering applications. *Engineering Applications of Artificial Intelligence*, 87, 103300.
- [25] Karaboga, D., & Basturk, B. (2007). A powerful and efficient algorithm for numerical function optimization: artificial bee colony (ABC) algorithm. *Journal of global optimization*, 39, 459-471.
- [26] Yang, X. S., & Slowik, A. (2020). Firefly algorithm. In *Swarm intelligence algorithms* (pp. 163-174). CRC Press.
- [27] Arora, S., & Singh, S. (2019). Butterfly optimization algorithm: a novel approach for global optimization. *Soft Computing*, 23, 715-734.
- [28] Guo, L., Wang, G. G., Gandomi, A. H., Alavi, A. H., & Duan, H. (2014). A new improved krill herd algorithm for global numerical optimization. *Neurocomputing*, 138, 392-402.
- [29] Heidari, A. A., Mirjalili, S., Faris, H., Aljarah, I., Mafarja, M., & Chen, H. (2019). Harris hawks optimization: Algorithm and applications. *Future generation computer systems*, 97, 849-872.
- [30] Mirjalili, S. (2015). Moth-flame optimization algorithm: A novel nature-inspired heuristic paradigm. *Knowledge-based systems*, 89, 228-249.
- [31] Mirjalili, S., Gandomi, A. H., Mirjalili, S. Z., Saremi, S., Faris, H., & Mirjalili, S. M. (2017). Salp Swarm Algorithm: A bio-inspired optimizer for engineering design problems. *Advances in engineering software*, 114, 163-191.
- [32] Mirjalili, S., & Lewis, A. (2016). The whale optimization algorithm. *Advances in engineering software*, 95, 51-67.

**NONLINEAR BEHAVIOR OF CIRCULAR SHALLOW ARCHES**

**Ayfer TEKİN ATACAN**

Asst. Prof., Yildiz Technical University

ORCID NO: 0000-0001-8161-1345

**Emre Can BAYKURT**

M.Sc. Student, Yildiz Technical University

ORCID NO: 0009-0000-2299-6935

**ABSTRACT**

One of the important conditions required in order for the structure to carry the external loads safely is the prevention of buckling. Under the influence of compressive loads, it is essential to consider the buckling problem of structural elements, which are thin compared to their length. Otherwise, although the compressive force acting on the structure is safe according to the allowable stress, it may cause the structure to collapse due to buckling. When examining buckling problems, the maximum force that the structure can carry without buckling is investigated, which is called the critical buckling load, thus ensuring that the external forces acting on the structure are less than the critical buckling load, keeping the structure safe. There are two modes of elastic instability, one of them is bifurcation of equilibrium that seeks a solution using the classical buckling theory, and the other is limit equilibrium, which requires snap-through buckling research. These modes depend on the state of the loading and the geometry of the structural element. For example, straight beams subjected to axial compression load exhibit a bifurcation buckling mode, while shallow arches that carry transverse loading mainly by compressive axial forces exhibit a snap-through buckling mode. In the snap-through buckling analysis, pre-buckling deformations are taken into account and the problem is handled as geometrically nonlinear. Shallow arches exhibiting snap-through behavior are frequently used in macro or micro dimensions in various fields of engineering such as civil, mechanical, and aviation.

**4TH INTERNATIONAL LATIN AMERICAN  
CONGRESS ON NATURAL AND APPLIED SCIENCES**

In this study, the snap through buckling problem of circular shallow arches with pinned support at both ends, under the effect of uniformly distributed vertical load, is investigated within the framework of the Euler Bernoulli beam theory. To solve this problem, firstly, the nonlinear differential equations are converted into nonlinear algebraic equations by using the finite differences method. Then, the nonlinear algebraic equations obtained are solved numerically using the Newton-Raphson method. In the solution of the problem, the effect of the modified slenderness ratio, which is a geometric parameter, on the snap-through buckling behavior should be examined. It is stated that the absence of buckling or the observance of a purely snap-through behavior depends on the values of the modified slenderness ratio. In this study, critical buckling loads are calculated for various values of the modified slenderness ratio of shallow arches.

This study provides insight about the design of the geometry of shallow arches, and contributes to their development through the improvement of knowledge about shallow arches.

**Keywords:** shallow arch, snap-through buckling, nonlinear equations, modified slenderness ratio

**Acknowledgements:** This work was supported by Yildiz Technical University Scientific Research Projects Coordination Unit. Project Number: FYL-2022-5167

**4TH INTERNATIONAL LATIN AMERICAN  
CONGRESS ON NATURAL AND APPLIED SCIENCES**

**YIELD RESPONSES OF WHEAT (TRITICUM AESTIVUM L.) TO EXOGENOUS  
APPLIED MORINGA LEAF EXTRACT (MLE)**

**Muhammad Adnan Arshad**

University of Agriculture Faisalabad, Faculty of Agriculture, Department of Agronomy,  
Faisalabad, Pakistan.

ORCID ID: <https://orcid.org/0000-0002-5905-7250>

**Asif Iqbal**

University of Agriculture Faisalabad, Faculty of Agriculture, Department of Agronomy,  
Faisalabad, Pakistan.

ORCID ID: <https://orcid.org/0000-0002-7235-0742>

**Umair Gull**

University of Agriculture Faisalabad, Faculty of Agriculture, Department of Agronomy,  
Faisalabad, Pakistan.

ORCID ID: <https://orcid.org/0000-0002-2261-8202>

**Muhammad Abdullah Saleem**

University of Agriculture Faisalabad, Faculty of Agriculture, Department of Agronomy,  
Faisalabad, Pakistan.

ORCID ID: <https://orcid.org/0000-0002-9900-5471>

**Saira Jamil**

University of Agriculture Faisalabad, Faculty of Sciences, Department of Botany, Faisalabad,  
Pakistan.

ORCID ID: <https://orcid.org/0000-0003-4635-1941>

**Abid Shehzad**

University of Agriculture Faisalabad, Faculty of Agriculture, Department of Agronomy,  
Faisalabad, Pakistan.

ORCID ID: <https://orcid.org/0000-0002-0789-1139>

**ABSTRACT**

Wheat is the staple food in Pakistan which is being consumed by the majority of population on daily basis. In recent years, a decline in wheat production while an upsurge in human population has been identified as serious threat to food security.

Moringa leaf extract (MLE) is one of the recently introduced bio-stimulant to enhance growth, yield and stress tolerance in plants. However, availability, shelf life and handling of

**4TH INTERNATIONAL LATIN AMERICAN  
CONGRESS ON NATURAL AND APPLIED SCIENCES**

MLE are the hindrances in its adaptability and marketing. A field experiment was conducted to evaluate the efficiency of MLE as bio-stimulant on wheat productivity. Experiment was performed at Agronomy Research Farm, University of Agriculture Faisalabad using Randomized Complete Block Design (RCBD) with three replicates to allocate the treatments. Data for different parameters was recorded and analyzed at 5% probability of LSD test. Treatments included were (T<sub>1</sub>=Control, T<sub>2</sub>= Priming with 3% Dry MLE, T<sub>3</sub>= Priming with 5% Dry MLE, T<sub>4</sub>= Priming with 3% fresh, T<sub>5</sub>= Priming with 5% Fresh MLE, T<sub>6</sub>=Foliar spray of 3% Dry MLE T<sub>7</sub>= Foliar spray of 5% Dry MLE, T<sub>8</sub>= Foliar spray of 5% Dry MLE, T<sub>9</sub>= Foliar spray of 5% Dry MLE). MLE either fresh or dry performed positively in enhancing the yield of field. Increase in wheat yield was observed in all treatments as compared to control. Highest wheat yield (4680.0 kg h<sup>-1</sup>) was recorded from treatment where 5% fresh MLE was applied as foliar spray which was 19.54% more as compared to control (3846.7 kg h<sup>-1</sup>). In addition, significantly the highest spike length, no. of productive tillers, grains per spike, biological yield, harvesting index, leaf area index, leaf area duration and crop growth rate observed were also increased in comparison to control. It is recommended from the current experiment to use 5% fresh MLE spray on wheat to enhance its production in an economic way.

**Keywords:** Wheat, MLE, Priming, Foliar application, Spray



**4TH INTERNATIONAL LATIN AMERICAN  
CONGRESS ON NATURAL AND APPLIED SCIENCES**

**EFFECT OF DIFFERENT SEEDING RATE AND HARVESTING INTERVAL ON  
THE FORAGE YIELD AND QUALITY OF MAIZE (*Zea mays* L.)**

**Bisma Yaseen**

University of Agriculture Faisalabad, Faculty of Sciences, Department of Botany, Faisalabad,  
Pakistan.

ORCID ID: <https://orcid.org/0000-0001-5662-489X>

**Asif Iqbal**

University of Agriculture Faisalabad, Faculty of Agriculture, Department of Agronomy,  
Faisalabad, Pakistan.

ORCID ID: <https://orcid.org/0000-0002-7235-0742>

authors e-mails: [asifiqbaldahasi@yahoo.com](mailto:asifiqbaldahasi@yahoo.com)

**Umair Gull**

University of Agriculture Faisalabad, Faculty of Agriculture, Department of Agronomy,  
Faisalabad, Pakistan.

ORCID ID: <https://orcid.org/0000-0002-2261-8202>

**Muhammad Abdullah Saleem**

University of Agriculture Faisalabad, Faculty of Agriculture, Department of Agronomy,  
Faisalabad, Pakistan.

ORCID ID: <https://orcid.org/0000-0002-9900-5471>

**Saira Jamil**

University of Agriculture Faisalabad, Faculty of Sciences, Department of Botany, Faisalabad,  
Pakistan.

ORCID ID: <https://orcid.org/0000-0003-4635-1941>

**Abid Shehzad**

University of Agriculture Faisalabad, Faculty of Agriculture, Department of Agronomy,  
Faisalabad, Pakistan.

ORCID ID: <https://orcid.org/0000-0002-0789-1139>

**ABSTRACT**

Increasing animal population in Pakistan is exerting pressure on agriculture sector to explore more sources and utilizing them more efficiently to feed the animals.

**4TH INTERNATIONAL LATIN AMERICAN  
CONGRESS ON NATURAL AND APPLIED SCIENCES**

Livestock in under nurished in the country due to less production potential and poor management practices by the farmers for fodder crops. Maize (*Zea mays* L.) is an excellent fodder crop because of its rapid growth, succulency, digestibility, outstanding quality and great productive potential. Optimal seed rate and harvesting interval of all fodderes play significant role in quality determination as delayed harvesting results in increased fiber contents with decreasing proteins. Therefore, a field experiment was conducted to investigate the effect of different seeding rates and harvesting interval on the forage yield and quality of maize (*Zea mays* L.) at Agronomic Research Area, University of Agriculture, Faisalabad during summer season, 2021. The experiment was conducted using Randomized Complete Block Design (RCBD) with factorail arrangemnet and replicated thrice. The experiment was comprised of two factors; seeding rate and harvesting interval. The treatments of seeding rates used were  $S_1=80 \text{ kg ha}^{-1}$ ,  $S_2=100 \text{ kg ha}^{-1}$  and  $S_3=120 \text{ kg ha}^{-1}$  while harvesting intervals were  $H_1=55$  days after sowing (DAS),  $H_2=65$  days after sowing and  $H_3=75$  days after sowing. Mazie variety “Pak Afgoi” was sown by hand drill with keeping 30cm row to row distance. Agronomic and quality factors were measured using standard methods and data collected was analyzed statistically using Fisher’s analysis of variance technique. Differences in treatment means were compared by using Tukey’s test at 5% level of significance. The results showed that seeding rate and harvesting interval significantly effected the agro-qualitative traits of forage maize. The maximum fresh weight per plant, dry weight per plant, fresh forage yield, dry matter percentage, dry matter yield and crude protein were obtained from the treatment where seeding rate of  $100 \text{ kg ha}^{-1}$  was used and the crop was harvested at 65 days after sowing.

**Keywords:** Maize, Seed rate, Harvesting interval, Fodder, Forage

**4TH INTERNATIONAL LATIN AMERICAN  
CONGRESS ON NATURAL AND APPLIED SCIENCES**

**PRODUCTION OF TRANSGENIC EDIBLE BANANA PLANT CONTAIN CT B  
GENE**

**Dr. R. Saravanan**

Professor, Faculty of Pharmacy, Bharath Institute of Higher Education and Research,  
Chennai-73, India.

**ABSTRACT:**

Plant biotechnology was promoted to express the foreign antigen in plant tissues as edible vaccine. Vaccination was the best known and most successful application of immunological principles to human health. <sup>1</sup>Recombinant DNA technology had already radically altered the field of vaccines. They understand better how our body interacts with microbes at the molecular level. Molecular biology also facilitates the development, production and delivery of safe and effective vaccines

In this study, CT-B gene was cloned into plant expression vector. The plasmid PCAMBIA was constructed by inserting the coding region for CT-B from PRK2013 together with pBluescript II KS between the Bam HI and EcoRI in the sites of PGA643 plant transformation vector and expressed in the plasmid (PCAMBIA). Here the study is to investigate the possibilities of cholera toxin B subunit to be used as a carrier of peptide vaccine by genetic approach. *Agrobacterium tumefaciens* is capable of infecting intact cells and introduces one of several copies of the transformed DNA in to the plant genome. *Agrobacterium tumefaciens* strain (LBA4404) is carrying the plasmid (pCAMBIA 1301) and will be used for the transformation studies. Constructed plasmid which contains the gene was transferred from its host *E.coli* strain (DH5 $\alpha$ ) in to *Agrobacterium tumefaciens* (LBA4404) by triparental matting method. In triparental matting *E.coli* harbouring plasmid (PRK2013) will be used as a helper. The result revealed the presence of 11.6 kDa CT-B antigen in constructed plasmid and experimentally confirmed. The transformed gene expression was used for the edible vaccine preparation in Banana Callus.

**Keywords:**Cholera, Vaccine, P CAMBIA, Gene Transfer,

**4TH INTERNATIONAL LATIN AMERICAN  
CONGRESS ON NATURAL AND APPLIED SCIENCES**

**BIODIVERSITY AND SEASONAL DISTRIBUTION OF CULICOIDES SPP. IN  
NORTH PART OF SERBIA (VOJVODINA)**

**Academician., Principal Res. Fell., Dr. Ivan PAVLOVIC**

Scientific Institute of Veterinary Medicine of Serbia, Belgrade, Serbia

ORCID ID: 0000-0003-4751-6760

**ABSTRACT**

Continuous entomological monitoring of *Culicoides* spp., was performed in Serbia from 2015 to 2019 on the basis of the Guidelines on how to conduct entomological examinations for the monitoring and control of blue tongue diseases in the territory of the Republic of Serbia, have so far yielded significant results related to biodiversity and seasonal dynamics of these insects Serbia. The research we have done so far has contributed to mapping the geographical distribution of the species we encounter as well as the variations in the number of populations in different years. As monitoring continues, we receive new valuable data every year that will help predict the movement of these insects on the basis of climate condition and enable preventative action to be taken to counteract them. Insects were collected using CDC light traps without dry ice and determination of *Culicoides* was performed by morphometric method recommended by the Italian National Reference Centre for Exotic Diseases CESME, Reference Laboratory for Bluetongue OIE, IZSAM from Teramo, Italy. In the Vojvodina Province, the presence of *Culicoides* spp was found in 38.46% samples in Novi Sad, in Pančevo in 44.18%, Subotica 59.25% and Sombor 40.90%. We did not detect the presence of *Culicoides* spp. in the epizootiological area of Zrenjanin. During examination we detected next species: *C. circumscriptus*, *C. deltus*, *C. fasciipennis*, *C. furcillatus*, *C. griseidorsum*, *C. lupicaris*, *C. nubeculosus*, *C. obsoletus*, *C. pallidicornis*, *C. parotti*, *C. picturatus*, *C. pulicaris*, *C. punctatus*, *C. scoticus* i *C. subfasciipenni*. Similar species were also found in border countries Hungaria, Croatia and Romania. *Culicoides* spp from to *Obsoletus* complexes, established at 60.05%. Males were found in 22.84% samples; non-pigmented (young) females in 67.97%, females taking the blood at 7.39%, and 1.35% were pregnant females. *Culicoides* spp. from *Pulicaris* complexes were found in 38.85% samples. Among tested samples, males were found in 18.91% samples, non-pigmented (young) females in 71.72%, females taking 9.09% and 1.11% pregnant females. Other types of *Culicoides* are set up in less than 10% of the examined samples. Usually, we have an average season distribution for these insects from April to October.

**Keywords:** *Culicoides* sp., biodiversity, season distribution, north part of Serbia (Vojvodina)

**MICROBIOTA MODULATION AS THERAPEUTIC APPROACH IN THE  
NEUROPATHIC PAIN IN DOG WITH SPINAL CORD INJURY: IMPACT OF  
POLENOPLASMIN**

**Major Gheorghe GIURGIU**

Deniplant-Aide Sante Medical Center, Biomedicine, Bucharest, Romania  
<https://orcid.org/0000-0002-5449-2712>

**Prof. dr. Manole COJOCARU**

Titu Maiorescu University, Faculty of Medicine, Bucharest, Romania  
<https://orcid.org/0000-0002-6871-577X>

**ABSTRACT**

Background Studies have demonstrated the presence of gut dysbiosis (alterations in gut bacterial homeostasis) secondary to spinal cord injury in dogs. The dysbiosis is thought to impair recovery by decreasing the production of short-chain fatty acids which play a role in suppressing inflammation within the central nervous system.

Objective Therefore, targeting gut dysbiosis could have significant therapeutic value in the management of spinal cord injury. The purpose of this study is to determine if gut dysbiosis occurs in dogs with spinal cord injury. Another area of potential intervention interest is in situations of spinal injury where there is an urgent need to generate new neurons. To arrive at these observations, the authors examined how Polenoplasmin and diet solve paralysis in dogs.

Materials and methods The most common cause of spinal problems in dogs is trauma. We are currently assessing whether indoles can also stimulate formation of neurons in dogs with paralysis.

Results We found that gut microbes that metabolize tryptophan-an essential amino acid-secrete small molecules called indoles, which stimulate the development of new brain cells in dogs, also demonstrated that the indole-mediated signals elicit key regulatory factors known to be important for the formation of new neurons.

Conclusion This study is another intriguing piece of the puzzle highlighting the importance of lifestyle factors and diet. The link between the health of the microbiome and the health of the brain shows how microorganisms in the gut solve paralysis, gut microbe secreted molecule linked to formation of new nerve cells in paralyzed dogs.

**Keywords:** gut dysbiosis, indole, paralyzed dog, Polenoplasmin.

**4TH INTERNATIONAL LATIN AMERICAN  
CONGRESS ON NATURAL AND APPLIED SCIENCES**

**BASIC MORPHOMETRIC PARAMETERS OF THE ANTLERS OF THE GOLDEN  
TROPHY RED DEERS (*Cervus elaphus* L.)**

**Milivoje Urošević**

PhD, DVM,MVM, Director of Science, Center for preservation of indigenous Breeds  
.Beograd-Zemun

**Milosava Matejević**

PhD Assot.Professor, Faculty of Science, University of Novi Sad, Serbia,

**Milena Milojević**

PhD Bs, Senior Lecturer, High-school for Agriculture, Šabac

**Tsegmid Namsrajav**

PhD. Senior Leteur, Mongolian University of life sciences, Agroecology school/Ecology  
department, Ulaanbaatar

**ABSTRACT**

Research was conducted on a sample consisting of 42 red deer antlers from hunting grounds in Hungary. The parameters that were analyzed (length of antlers, circumference of the antlers, length of brow tines, length of tray tines, circumference of coronets, circumference of below the coronets, number of tine ends and the weight of the antlers) were measured according to the propositions adopted by the The International Council for Game and Wildlife. The aim of the paper was to determine the absolute and mean values of the length of antlers, the circumference of the antlers, length of brow tines, length of tray tines, circumference of coronets, circumference of below the coronets, number of tine ends and the weight of the antlers, as well as the existence of mutual dependence between certain parameters of reed deer trophies. Using the method of descriptive statistics, the mean values were obtained. Using the method of descriptive statistics, the mean values of the length of the left and right antlers were obtained, and it was determined that the left antler was slightly more developed in the observed population. Namely, the mean value of the length of the left antler is larger, while the mean values of the length of tines are almost the same. The results of Pearson's correlation showed a statistically significant positive correlation between certain morphometric parameters of the antlers, such as the length of the antlers and brow tines. However, the results of Pearson's correlation showed, also, a statistically significant negative correlation between certain morphometric parameters of the antlers, such as the length of the antlers circumference of the antlers.

**Keywords:** red deer, antlers, morphometry, trophy, morphometric characteristics



## **Introduction**

Red deer (*Cervus elaphus hippelaphus* L.1758) is part of the large ruminant family (*Cervidae*), and belongs to a group of hunting game that can not found in all areas. Historically, the reduction of forest areas and significant biotope changes have caused this game to have a smaller area of distribution. It inhabits most of Europe. In Europe, red deer is mostly found in areas around rivers such as the Danube, Sava, and Drava, and in large forest areas in Hungary, Croatia, Serbia, Romania, Austria, Germany. It also lives in Poland, the Baltic States, and Scandinavia. It is extremely numerous in Great Britain and Spain. Of course, it is also found on the American continent, Africa, Asia. Today, in many areas, intensive reintroduction of deer is being carried out in the habitats where it used to be. When it comes to Central Europe, it can be said that Hungary has the largest population of this game.

Red deer is an attractive hunting game, basicly because of its specific antlers. Hunters are specially interested in trophy of the reed deer. It does not have a particularly wide span between its horns, and this allows it to move more easily in the forest, where it lives most of the time. The height of the body at the withers is from 120 cm to 150 cm, and the length of the body is 225-275 cm.

The aim of this paper is to analyze the antlers of the deer, awarded with a gold medal. In the available literature, there is no data on the analysis of only gold medal trophies. The aim of the paper was to determine the absolute and mean values of the length of antlers, the circumference of the antlers, length of brow tines, length of tray tines, circumference of coronets, circumference of below the coronets, number of tine ends and the weight of the antlers, as well as the existence of mutual dependence between certain parameters of reed deer trophies.

Analyzing 96 deer trophies at the exhibition in Njitra, held in 1990, Hell and Bakoš (1991) determined that the average length of the antler was 110.28 cm, the length of brow tines 38.97 cm, length of tray tines 36.62 cm. The circumference of the coronets, on average, was 26.51 cm.

On a sample of 110 trophies, Garaj (1993) determined that the average length of the antlers is 104.60 cm, the length of brow tines 36.10 cm, the length of tray tines 36.80 cm. The circumference of the coronets, on average, was 23.30 cm. Studying the trophies of red deer, which lived in similar climatic conditions as the deer whose trophies studied in this study, Degmečić (2010) found that the average length of the antlers was 105.74 cm, and the average length of brow tines 47.54 cm. The average value of the circumference of the coronets was 25.89 cm.

Dogmačić and Florijančić (2014) determined that the maximum length of the antlers is 121.00 cm. The authors also examined red deer that lived in similar conditions as the deer whose trophies we examined. In an extremely extensive study on the characteristics of red deer antlers, they concluded, on a sample of 41 deer, that the average length of the antlers (in deer that lived in the wild and had 6 tines) was 66.117 cm, and in those from the fenced hunting grounds it was 54.98 cm. When it comes to ten-year-olds individuals from the free nature had an average antlers' length of 84.50 cm, and from the fenced area 77.51 cm.

Novaković (1999) reports that the length of tray tine at the age of five years is 35.90 cm, and the length of the brow tine is 39.50 cm. When it comes to 12-year-old individuals, the average length of the brow tine is 42.40 cm, and the length of the tray tine one is 39.0 cm. Urošević et

## 4TH INTERNATIONAL LATIN AMERICAN CONGRESS ON NATURAL AND APPLIED SCIENCES

al. (2018) studying the morphological characteristics of deer antlers in mountain and lowland hunting grounds found that there is a very significant statistical difference in the length of the left antler, between horns from hilly and plain hunting grounds. The same statistical significance was found in the right antlers. The maximum length of the left antler of the lowland red deer was 119.4 cm, and that of the mountain red deer was 123.5 cm. When it comes to the length of the right antlers, its maximum value in lowland red deers was 115.6 cm, and in mountain red deers 117.0 cm. The circumference of the left coronet had a maximum value of 29.8 cm in red deer from plains, and 29.7 cm in mountain red deers. When it comes to the circumference of the right coronet, the maximum value in red deers from plains was 30.0 cm, and in mountain 29.9 cm.

Studying deer trophies from Deliblatska peščara (Serbia), Bradvarović (2017) reports that the maximum length of the left antler is 119.00 cm with its circumference of 21.0 cm. For the right antler, the maximum length was 116.40 cm with a maximum circumference of 30.0 cm.

Stepanova and Argunov (2016) state that the maximum length of a deer antlers, with 6-7 tines, in Yakutia, Siberia (Russia), is 92.0 cm. In the same individuals, the circumference of the coronets was between 23-29 cm, and the circumference of the antlers was 11-17 cm. Urošević (2015) determined that the average length of the antlers, in a sample of 50 individuals, in deer from lowland hunting grounds in the northwest of Serbia, is 97.93 cm, and the right antler is 97.72 cm. The average length of the left brow tines was 37.96 cm, and the right one was 37.27 cm.

Rajsky et al. (2003) determined that the average length of the antler, with a deer aged 12 years, was 100.8 cm. The brow tine, at that age, had an average length of 36.2 cm. The average circumference of the coronets was 26.1 cm.

### **Material and Methods**

In this study, the morphometric parameters of gold trophies of red deer shot in hunting grounds in Hungary, in the period from 1960 to 1966, were analyzed. The research was conducted on a sample consisting of 42 antlers. Evaluating was done by authorized CIC experts, and confirmation was done at official hunting trophy exhibition in Budapest (1971). The parameters that were analyzed were measured according to the propositions adopted by the CIC - The International Council for Game and Wildlife. The trophy lists were published in book „10 év aranyermes trofeai“. Observed parameters were length of antlers, circumference of the antlers, length of brow tines, length of tray tines, circumference of coronets, circumference of below the coronets, number of tine ends and the weight of the antlers. The data were first processed using the method of descriptive statistics, then the Pearson correlation method was used to determine the dependence between the observed parameters. The collected data were processed with the Statistical Package for the Social Sciences (SPSS) for Windows Release 17.0.0 software.

### **Results**

The lengths of the left antlers ranged from 99 cm to 123.60 cm, and the lengths of the right antlers ranged from 96 cm to 126.5 cm. Using the method of descriptive statistics, the mean values of the length of the left antlers  $M=110.04$  cm,  $SD=7.14365$  and the length of the right antlers  $M=109.72$ cm,  $SD=7.04830$  were obtained (table 1).

**4TH INTERNATIONAL LATIN AMERICAN  
CONGRESS ON NATURAL AND APPLIED SCIENCES**

The lengths of the left brow tines ranged from 31.50 cm to 58.20 cm, and the lengths of the right brow tines ranged from 25.50 cm to 55.30 cm. Using the method of descriptive statistics, the mean values of the length of the left brow tine  $M=42.2429$  cm,  $SD=5.52913$  and the length of the right brow tine  $M=41.3857$ cm,  $SD=6.16638$  were obtained.

The lengths of the left tray tines ranged from 26.30 cm to 61.90 cm, and the lengths of the right tray tines ranged from 33.00 cm to 62.10 cm. The average lengths were calculated, and the mean values of the length of the left tray tine was  $M=44.6905$  cm,  $SD=7.43646$  and the length of the right tray tine was  $M=44.7905$  cm,  $SD=7.42526$ .

*Table 1. Descriptive statistical indicators for some elements of trophies*

	N	Min	Max	Mean	Std. Deviation
Length of left antler	42	99.00	123.60	110.0429	7.14365
Length of right antler	42	96.00	126.50	109.7262	7.04830
Length of left brow tines	42	31.50	58.20	42.2429	5.52913
Length of right brow tines	42	25.50	55.30	41.3857	6.16638
Length of left tray tines	42	26.30	61.90	44.6905	7.43646
Length of right tray tines	42	33.00	62.10	44.7905	7.42526
Weight of the antlers	42	7.72	13.60	9.9326	1.11884
Number of tine ends on right antler	42	6.00	12.00	8.4286	1.48394
Number of tine ends on left antler	42	6.00	12.00	8.1667	1.63672
Valid N (listwise)	42				

Table 2 shows descriptive indicators for circumferences. The circumference of left coronets ranged from 24.2 cm to 31.2 cm, and circumference below left coronets from 10.10 cm to 20.80 cm. The circumference of right coronets ranged from 24.60 cm to 31.60 cm, and circumference below left coronets from 15.80 cm to 20.70 cm. Using the method of descriptive statistics, the mean values of the circumference of left coronets were obtained  $M=28.57$  cm,  $SD=1.72401$ ; the mean values of the circumference below left coronets were obtained  $M=17.72$  cm,  $SD=1.66697$ ; the mean values of the circumference of right coronets were obtained  $M=28.7857$  cm,  $SD=1.73607$ ; the mean values of the circumference below right coronets were obtained  $M=18.24$  cm,  $SD=1.10787$  (table 2).

*Table 2. Descriptive statistical indicators for circumferences*

	N	Min	Max	Mean	Std. Deviation
Circumference of left coronets	42	24.20	31.20	28.5738	1.72401
Circumference of right coronets	42	24.60	31.60	28.7857	1.73607
Circumference below right coronets	42	15.80	20.70	18.2464	1.10787
Circumference below left coronets	42	10.10	20.80	17.7226	1.66697

**4TH INTERNATIONAL LATIN AMERICAN  
CONGRESS ON NATURAL AND APPLIED SCIENCES**

Circumference of left antler	42	14.70	21.00	16.5119	1.19372
Circumference of right antler	42	14.70	20.00	16.7190	1.21097
Valid N (listwise)	42				

The results of Pearson's correlation showed a statistically significant correlation between certain morphometric parameters of the antlers. There is a significant statistical positive correlation between the lengths of the antlers ( $r=0.732$ ,  $p<0.05$ ) and lengths of the brow tines ( $r=0.752$ ,  $p<0.05$ ). Also, positive correlation was found between length of the antlers and length of the brow tines, longer antlers have longer brow tines (table 3).

*Table 3. Correlations between length of some parameters*

		Length of left antler	Length of right antler	Length of left brow tines	Length of right brow tines
Length of left antler	Pearson Correlation	1	.732**	.471**	.454**
	Sig. (2-tailed)		.000	.002	.003
	N	42	42	42	42
Length of right antler	Pearson Correlation	.732**	1	.296	.390*
	Sig. (2-tailed)	.000		.057	.011
	N	42	42	42	42
Length of left brow tines	Pearson Correlation	.471**	.296	1	.752**
	Sig. (2-tailed)	.002	.057		.000
	N	42	42	42	42
Length of right brow tines	Pearson Correlation	.454**	.390*	.752**	1
	Sig. (2-tailed)	.003	.011	.000	
	N	42	42	42	42

\*\* . Correlation is significant at the 0.01 level (2-tailed).

\* . Correlation is significant at the 0.05 level (2-tailed).

Significant negative correlation between certain morphometric parameters of the antlers was also found (table 4). According to results, longer antlers have bigger circumference of the antlers.

*Table 4. Correlations between measured trophy elements*

		Length of left antler	Length of right antler	Circumference of left antler	Circumference of right antler
Length of left antler	Pearson Correlation	1	.732**	-.323*	-.367*
	Sig. (2-tailed)		.000	.037	.017
	N	42	42	42	42
Length of right antler	Pearson Correlation	.732**	1	-.371*	-.455**

**4TH INTERNATIONAL LATIN AMERICAN  
CONGRESS ON NATURAL AND APPLIED SCIENCES**

	Sig. (2-tailed)	.000		.016	.002
	N	42	42	42	42
Circumference of left antler	Pearson Correlation	-.323*	-.371*	1	.712**
	Sig. (2-tailed)	.037	.016		.000
	N	42	42	42	42
Circumference of right antler	Pearson Correlation	-.367*	-.455**	.712**	1
	Sig. (2-tailed)	.017	.002	.000	
	N	42	42	42	42

\*\* . Correlation is significant at the 0.01 level (2-tailed).

\* . Correlation is significant at the 0.05 level (2-tailed).

### Conclusion

The results of the research showed the absolute values of the length of the left antlers and the right antlers and tines, the circumference of the antlers and coronets, number of the tines, but also the existence of mutual dependence between certain parameters of red deer trophies. Using the method of descriptive statistics, the mean values of the length of the left and right antlers were obtained, and it was determined that the left antler was slightly more developed in the observed population. Namely, the mean value of the length of the left antler is larger, while the mean values of the length of tines are almost the same. The results of Pearson's correlation showed a statistically significant positive correlation between certain morphometric parameters of the antlers, such as the length of the antlers and brow tines. However, the results of Pearson's correlation showed, also, a statistically significant negative correlation between certain morphometric parameters of the antlers, such as the length of the antlers circumference of the antlers.

### References

1. Bakkay L., Szidnai L., Szabolcs J., 1971. 10 év aranyermes trofeai -Goldmedaillen-Trophäen des letzten Jahrzehntes (1960-1969). Mezőgazdasági Kiado, Budapest.
2. Bradvarović J. 2017. Jeleni dunavsko-karpatkog basena. Udruženje za zaštitu Dunava i Save Republike Srbije.
3. Degmečić D., 2010. Blago baranjskog podunavlja, LSH, Zagreb.
4. Degmečić D., Florijančić T., 2014. Utjecaj klimatskih i hidroloških čimbenika na razvoj rogovlja jelena običnog (*Cervus elpahun* L.) u hrvatskom dijelu baranjskog podunavlja. Šumarski list 9-10, str. 451-461
5. Garaj P. 1993. Študija trofejovej kvality jelenej zveri v chovnej polovnej oblasti Slanske vrchy. Folia Venatoria 23, str. 51-60.
6. Hell P., Bakoš A. 1991. zhodnotenie vyvoja trofejovej kvality raticovej zveri i ČSFR za poslednych 15 Rokov. Folia Venatoria 21, str.163-193
7. Novaković V. 1999. Jelen (*Cervus elaphus*, L.). Ministarstvo poljoprivrede, šumarstva i vodoprivrede RS, Beograd.
8. Rajskey M., Pavlik Š., Rajskey D. 2003. Rast parožita a trofejova kvalita jelenej zveri v podunajskej polovnej oblasti. Folia Venatoria 33, str. 33-44.

**4TH INTERNATIONAL LATIN AMERICAN  
CONGRESS ON NATURAL AND APPLIED SCIENCES**

9. Romić S., 1979. Utjecaj načina života i hranidbe jelena na osobine njihovog rogovlja. Arhiv za lovstvo, 3-4, str.1-94. LSH,Zagreb.
10. Stepanova V., Argunov A. 2016. Morfometrija rogova blagorodnog jelena (*Cervus elaphus* L. 1758) u Jakutiji. Vestnik Udmurskog Univerziteta, T.26, 1, str. 126-132 (В.В.Степанова, А.В.Аргунов, 2016. Морфометрия рогов благородного оленя (*Cervus elaphus* L. 1758) Якутии. Вестник Удмуртского Университета. Биология науки о земле. Т.26, вып.1, стр. 126132.
11. Urošević M.M., Drobnjak D., Urošević B.M., Čeranić A., Živković B. 2018. Osnovne morfološke karakteristike parogova jelena (*Cervus elaphus*) u brdskim i ravničarskim lovištima, (Basic morphological traits of Antlers of Rede Deer (*Cervus elaphus*) from lowland and mountainous Areas) 8. Naučni skup o lovstvu i lovnom turizmu. Zbornik radova, str.95 - 102.
12. Urošević B.M. 2015. Morfološke karakteristike parogova jelena u lovištima istočne i severozapadne Srbije. Specijalistički rad. Poljoprivredni fakultet, Beograd-Zemun.



**4TH INTERNATIONAL LATIN AMERICAN  
CONGRESS ON NATURAL AND APPLIED SCIENCES**

**PREPARATION AND EVALUATION OF NANOPARTICLES OF ZINC OXIDE  
COATED INTRAMAMMARY INFUSION FOR THE TREATMENT OF  
SUBCLINICAL BOVINE MASTITIS**

**Muhammad Waris MAJEED**

Department of Clinical Medicine & Surgery, Faculty of Veterinary Science  
University of Agriculture, Faisalabad, Pakistan.  
Veterinary Officer, Livestock & Dairy Development Department Govt. of Punjab,  
Pakistan.

**Hafiz Qadeer AHMED**

Institute of Animal and Dairy Sciences, University of Agriculture, Faisalabad, Pakistan.  
Veterinary Officer, Livestock & Dairy Development Department Govt. of Punjab,  
Pakistan.

**ABSTRACT**

Mastitis in dairy animals is highly prevalent infectious disease causing considerable economic losses estimated to be \$35 billion annually at world level. Various traditional medications have been used for treatment of mastitis such as herbal, homeopathic and antibiotics. The increasing microbial resistance and antibiotic failure in the treatment needs to find other effective ways. The use of nanoparticles-based therapy is cheap with excellent efficacy. Inorganic metal nanoparticles proved to be helpful in improving the health of udder and teat. The present study was conducted to check efficiency of Zinc Oxide nanoparticles in the treatment of subclinical mastitis in cattle. The study was consist of 50 animals divided into five groups, each having 10 animals. The diagnosis of subclinical mastitic animals was confirmed on basis of Surf Field Mastitis Test. Evaluation was done by SFMT score, somatic cell count and milk composition(Fat, Protein and SNF contents) and Draminiski mastitis detector reading on day 0,day 07 and day 14 post imitation of treatment. Bacteriological examination was also performed to isolate the bacteria casuing subclinical mastitis. The results shows there was significant decrease in SFMT score in animals of group treatment III in which animals were given amoxicillin 15% along with intramammary infusion of ZnO nanoparticles. The Draminiski value increases significantly, Somatic cell count decreased and

**4TH INTERNATIONAL LATIN AMERICAN  
CONGRESS ON NATURAL AND APPLIED SCIENCES**

milk composition improved after giving combination of non anti antibiotic and antibiotic. As for as could be ascertained from the available literature, The present study is the first one on Preparation and evaluation of ZnO nanoparticles cated intramammary infusion for the treatment of subclinical mastitis in bovines.

**Key words:** Bovine, sub clinical mastitis, zinc oxide, nano particles, intramammary infusion

**4TH INTERNATIONAL LATIN AMERICAN  
CONGRESS ON NATURAL AND APPLIED SCIENCES**

**A META-ANALYSIS OF THE ASSOCIATION BETWEEN PROLACTIN (PRL)  
GENE POLYMORPHISM WITH LACTATION MILK YIELD AND PROTEIN  
PRODUCTION TRAITS IN CATTLE**

**Memiş Özdemir**

Prof. Dr., Atatürk Üniversitesi

ORCID: 0000-0002-1301-0270

**Zekrullah Motmain**

Atatürk Üniversitesi

ORCID: 0000-0003-3644-1054

**Kübra Ekinci**

Arş. Gör., Atatürk Üniversitesi

ORCID: 0000-0002-0877-1358

**Esranur Saygılı**

Atatürk Üniversitesi

ORCID: 0000-0002-9701-1544

**ABSTRACT**

In certain areas of animal research summarizations of literature data are needed, statistical methods dealing for the analysis of summary data from the literature are known as meta-analysis. The method of meta-analysis is used to combine the result from several independent studies which have been done in different regions or areas on a specific subject as qualitative and quantitative and assist to achieve a consensus. The current meta-analysis was performed to provide the association between prolactin PRL polymorphism with some productive milk traits in Holstein crossbreed dairy cattle. The data was collected from the years 2002 to 2021 and a total of 26 published studies were included in milk yield study, 14 studies for protein yield, and 18 studies included for protein content. For the performance of statistical evaluation four genetic models, dominant; AA + AB versus BB, recessive; AA versus AB + BB, co-dominant; AA versus BB versus AB were employed to obtain standardized mean difference (SMD) between genotypes. In this analysis cattle with AB

versus BB genotype (SMD= 0.289, 95% CI 0.005, 0.573) and a statistically significant ( $p < 0.05$ ) higher protein yield were found compared to AA versus AB and AA versus BB genotype. In the remaining cases, the association between prolactin polymorphism and milk yield and protein content was not statistically significant ( $p > 0.05$ ).

**Keywords:** Meta-analysis, crossbreed, Polymorphism, co-dominant, PRL, SMD.

## **1. Introduction**

Milk production traits are very important in dairy cattle. Breeding programs are the main factor in dairy farming to achieve and improve these traits. Genomic selection increases the efficiency of selection more than traditional methods. Selection methods at the DNA and quantitative trait locus (QTL) level can assist in speeding up quantitative selection by diagnosing major genes that control important economic traits [1],[21].

The research on genetics mainly focuses to identify genes with important economically traits. Most studies on dairy cattle have identified genes determining variations in milk production traits[16]. Meta-analysis represents a statistical test or technique employed to combine the results of multiple studies into a single estimate. The results of a meta-analysis increase the precision of estimates of effect, and new hypotheses are established [15]. The process of milk production is complicated and prolactin is one of the most essential hormones in this process [12]. PRL genes, which are necessary for the development of mammary glands and milk production[5] [11]. It produced by the anterior pituitary gland and plays a key role in lactogenesis, synthesis, regulating the growth of the udder, and secretion of milk proteins in dairy cows [6]. The prolactin (PRL) gene is found on chromosome 23, is approximately 10 kb in size, includes 5 exons and 4 introns, and encodes a 199 amino-acid polypeptide [6],[16]. This site plays as a genetic marker for the genetic characterization of cattle populations [16].

The polymorphisms in prolactin (PRL) gene has significant associations with milk traits cattle [6],[14]. A change of adenine to guanine (A103G) in prolactin gene make a point mutation, the outcome is two alleles (A and B). Three genotypic patterns AA, BB and AB were revealed from the digestion of a 156 bp fragment of exon 3 region in the prolactin gene by RsaI. [18][2]. The present analysis was carry out to combine results from different studies related to prolactin gene polymorphism and its relationship with protein and milk yield.

## **2. Material and Methods**

The studies related to this research were searched in Scientific journals. For the obtaining of a standardized mean difference two effect models (the random effect model and the fixed effect model) are used. Q statistic was employed for estimation of heterogeneity between studies.

The selection of models defined from the study effect were homogeneous or heterogeneous and Cohen's method was used for the standardized mean difference [16].

In this study, the  $I^2$  test was conducted with the objective of estimating heterogeneity between the studies. The random effect model was applied due to the high heterogeneity.

### **2.1, Data Extraction and search strategy.**

The data were extracted and removed errors by authors and a total of 26 published studies were included in milk yield, 14 studies for protein yield, and 18 studies for protein content. The important information, involves the author's name, sample size, the year of publication, breed, lactation milk yield (LMY), protein yield, genotypes, and country.

Essential criteria were used for data collection and study selection. A comprehensive search was done among studies published in different languages, journals, and databases on the association between prolactin (PRL) gene polymorphism with lactation milk and protein production traits in cattle. A comprehensive search was done with Springer, ResearchGate, Google Scholar, Wiley, PubMed, and Elsevier for studies.

### **2.2, Statistical Analysis**

The Stata 11.2 software (StataCorp 2001; Stata Statistical Software) was used in this analysis and  $P < 0.05$  was accepted as a significance level. For the gene locus, the database was arranged individually, and the four methods below were followed;

- The following four genetic models were selected in this investigation: dominant; AA + AB versus BB, recessive; AA versus AB + BB, co-dominant; AA versus BB versus AB.
- Two effect models (random and fixed) were used to define the difference between means.
- The standardized mean differences (SMDs) and standard deviation were computed at a 95% CI (Confidence Interval) to estimate the capabilities between the three genetic models for every trait.
- Cohen's method is used for standardized mean differences( SMD) to assess the effect size.

### **3. Results and Discussion**

In the present meta-analysis, two productive traits (lactation milk yield and protein yield) were investigated. Each character was analyzed separately, random and fixed effect models are used and.

Meta-analysis offers a more powerful analysis. When more similar studies have been performed on a particular subject there is a need for meta-analysis and there will be differences of opinion in some of these studies. Table 1 contains the statuses of the heritage

**4TH INTERNATIONAL LATIN AMERICAN  
CONGRESS ON NATURAL AND APPLIED SCIENCES**

pattern of alleles with the results for heterogeneity, standardized mean difference (SMD) with a 95% CI, and significances.

Table1. Results of meta-analysis of the association between PRL polymorphism and milk traits

Traits	n	AA Versus AB						AA Versus BB						AB Versus BB					
		I <sup>2</sup>	model	SMD	90%	CI	P	I <sup>2</sup>	model	SMD	90%	CI	P	I <sup>2</sup>	model	SMD	90%	CI	P
Lactaion milk yield	26	47.1**	R	0.011	-0.074	0.096	0.796	32.7*	R	0.1	-0.010	0.022	0.470	39.9*	R	0.087	-0.063	0.237	0.252
Protein yield	14	4.3	F	-0.057	-0.125	0.011	0.101	15.8	F	-0.03	-0.213	0.146	0.717	62.2**	R	0.289	0.0005	0.573	<b>0.046</b>
Protein content	18	0.0	F	0.006	-0.054	0.066	0.851	0.0	F	-0.01	-0.145	0.118	0.846	0.0	F	0.030	-0.096	0.156	0.642

\* P<0.10; \*\* P<0.01; n: number of publication; I<sup>2</sup>: variation in SMD attributable to heterogeneity; F: Fixed; R: Random

In the analysis of 26 studies for lactation milk yield (LMY), all genotypes showed no significant (P>0.05) effect on milk yield. A similar result is obtained by many researchers [18]. However, the obtained results contradict with obtained by some other researchers [4],[8], [7],[9], indicating that the polymorphisms of the prolactin gene had an impact on milk yield.

In protein yield, the association between polymorphisms in prolactin gene and the AB and BB genotype was found a significant (P<0.05) and it is same as the results were reported by some authors [4],[8],[20], [10],[21]. However, this result is different from the results reported by [7]. Considering protein content, no significant association was revealed between prolactin gene polymorphisms and all genetic models (P>0.05). Similar results were reported by a number of authors [4],[8], [10],[13],[19]. It is thought that the results obtained in this study will make a contribution to developing new strategies necessary for breeding dairy cattle. In accordance with the results obtained from the current meta-analysis, a single significant association was found between prolactin gene polymorphism and protein yield in the AB and BB genotypes. No significant associations were observed between milk yield, protein yield, and protein content. Since various conflicting results have been reported by the authors on this subject, more studies should be conducted to determine the PRL gene polymorphism and investigate its impact on milk yield traits. Moreover, to obtain more reliable results, the genotype x environment interaction should be taken into account, group comparisons should



be made to minimize outcome variability with more articles, and the usability of the results obtained by applying the correct statistical model for breeding purposes should be discussed.

#### **4. Conclusions**

According to the results obtained from the meta-analysis of this study. The significant result was found among the polymorphism of prolactin gene and protein yield in AB vs BB genotype. The non-significant association of PRL polymorphism observed with the genotype of milk yield and protein content. Several results reported by the authors which were in contrast with this study. Therefore more study should be done for determination of polymorphism of PRL gene and its effect on milk production traits.

#### **References**

1. A. Anggraeni, C. Sumantri, A.Saputra and L. Praharani, "Association Between GH (g.1456inst), GHRH (g.4474(<A), and Pit-1 (g.244G>A) Polymorphisms and Lactation Traits In Holstein Friesian Cattle," Tropical Anim Sci Journal., vol.43,pp. 291-299. 2020.
2. B. Akyüz, K. Arslan , D. Bayram and K. M. İşcan, "Allelic frequency of kappa casein, growth hormone and prolactin gene in Holstein, Brown Swiss and Simmental cattle breeds in Turkey," Kafkas Univ Vet Fak Derg, Vol. 3, pp. 439-444. 2013.
3. M. Akkaya and B. Akyuz, " Investigation of the Relationship between GHRH and PRL Genes Polymorphisms and Milk Yield in Holstein Cattle Breed Reared in Turkey," KSU J Agric Nat, Vol. 5, pp.763-771, 2019.
4. M.Alipanah, L. Kalashnikova , G. Rodionov, "Association of prolactin gene variants with milk production traits in Russian Red Pied cattle,"Iran J Biotechnol, Vol.5, pp. 158-161, 2007.
5. K. Arslan , S. Taheri , E.F. Şener, B. Akyüz , A. Akçay , Y. Özkul and K.M. İşcan, "Investigation of the promoter polymorphisms of the growth hormone(GH1), growth hormone receptor (GHR), insulin-like growth factor (IGF-I), and prolactin (PRL) genes and the correlation between gene expression and milk yields in Holstein cattle raised in Central Anatolia," Turk J Vet Anim Sci, Vol. 40, pp. 609-615, 2016.
6. Y.C. Bangar, C.S Patil, A. Magotra and A.S. Yadav, "Meta-analysis of gene polymorphism of beta-lactoglobulin gene in indian dairy cows," Biochem Genet, vol.3, pp. 1039-1048, 2022.

**4TH INTERNATIONAL LATIN AMERICAN  
CONGRESS ON NATURAL AND APPLIED SCIENCES**

7. J. Boleckova , J.Matejickova, M.Stipkova, J. Kyselova and L. Barton, “The association of five polymorphisms with milk production traits in Czech Fleckvieh cattle,”. Czech J Anim Sci, Vol. 57,pp. 45-53, 2012.
8. P.Brym,S. Kaminski and E. Wojcik , “Nucleotide sequence polymorphism within exon 4 of the bovine prolactin gene and its associations with milkperformance traits,” J Appl Genet, Vol. 4, pp.179-185, 2005.
9. C.H. Dong, X.M. Song, L. Zhang , J. F. Jiang, J.P.Zhou and Y.Q. Jiang , “New insights into the prolactin-RsaI (PRL-RsaI) locus in Chinese Holstein cows and its effect on milk performance traits,” Genet Mol Res, 12, 5766-5773,2013. DOI: 10.4238/2013.November.22.3
10. A. Dybus, W. Grzesiak, H. Kamieniecki, I. Szatkowsk , Z. Sobek, P. Blaszczyk, P.E. Czerniawska, S. Zych and M. Muszynska , “Association of genetic variants of bovine prolactin with milk production traits of Black-and-White and Jersey cattle,” Arch Tierzucht, vol. 48, pp. 149-156, 2005.
11. M.A. Edriss, V. Edriss , H.R. Rahmani, “Association Of PIT-1 Gene Polymorphism With Birth Weight, Milk And Reproduction Traits In Isfahan Holstein Cows” Archiv Tierzucht. Vol. 52, pp. 445-447, 2009.
12. N. Ghasemi, M.Z. Rahmani, G. Rahimi and S.H. Hafezian Associations between prolactin gene polymorphism and milk production in montebeliard cows. Int J Gen Mol Biol, vol. 1, pp. 48-51, 2009.
13. L. A. Kalashnikova, Y.A , Khabibrakhmanova, A. Tinaev, “Effect of polymorphism of milk protein and hormone genes on milk productivity of Black Pied cows,” Russ Agri Sci, Vol. 35, pp. 192-195, 2009.
14. A. Lu , X. Hu , H. Chen , J. Jiang, C. Zhang , H. Xu , H. Gao , “Single nucleotide polymorphisms in bovine PRL gene and their associations with milk production traits in Chinese Holsteins,” Mol Biol Rep, Vol. 37, pp. 547-551, 2010.
15. I. J. Lean , A. R. Rabiee , T. Duffield, I. Fand and R. Dohoo, “ Invited Review: Use Of Meta-Analysis In Animal Health And Reproduction Methods And Applications,” J Dairy Sci. Vol. 92, pp. 3545–3565. 2009.
16. Z. Motmain , M. Ozdemir, K. Ekinici and E. Saygılı and E. Bilgin , “A Meta-Analysis of the Associations Between Prolactin (PRL) Gene Polymorphism and Milk Production Traits in Cattle,” Kafkas Univ Vet Fak Derg, vol. 28, pp.627-631, 2022.
17. M. Ozdemir, S. Kapuzlu, M. Topal and O.C. Bilgin, “Relationships between milkprotein polymorphisms a nd production traits in cattle: A systematic review and meta-analysis,”. Arch Anim Breed, Vol. 61, pp.197-206, 2018.
18. M.Ozdemir, Z. Sonmez, V. Aksakal,” Associations between PRL/RsaI polymorphism and some performance traits in Holstein cattle reared underorganic condition. J Anim Plant Sci, Vol. 31, pp. 900-905, 2021.

**4TH INTERNATIONAL LATIN AMERICAN  
CONGRESS ON NATURAL AND APPLIED SCIENCES**

19. J.C. Rincon, L. Herrera and J.J. Echeverri JJ, “Effect of two single nucleotide polymorphisms on milk yield and composition,”. Genet Mol Res, Vol. 12. pp. 995-1004, 2013.
20. G. Sacravarty, V.P.Vadodaria, C.G. Joshi, B.P. Brahmkshtri, R.R.Shah and J.V Solanki, “Prolactin gene polymorphism and its association with economic traits in Kankrej cattle,” Indian J Dairy Sci, Vol. 61 , pp. 273-276, 2008.
21. N.T.D. Thuy, N.T. Thu, L.V.T. Cuong ,T.T.B. Nguyen and D.V.A. Khoa (2018) Polymorphism Of PIT-1 And Prolactin Genes And Their Effects On Milk Yield In Holstein Frisian Dairy Cows Bred In Vietnam. Russian Journal Of Genetics. 54:346–352, 2018.

**ROLE OF RUTIN IN ATTENUATION OF METABOLIC GLUCOSE AND INSULIN  
IMPAIRMENT**

**Dr. Wafa Majeed**

Department of Pharmacy, University of Agriculture, Faisalabad.

**Dr. Muhammad Saad Tariq**

Institute of Physiology and Pharmacology, University of Agriculture, Faisalabad.

**ABSTRACT**

Diabetes mellitus is a condition that affects the body's ability to produce insulin. DM occurs when the pancreas is unable to secrete insulin and the body's insulin isn't used properly. The purpose of the current investigation was to assess how rutin contributes to the reduction of impaired insulin secretion and glucose metabolism. Antioxidant, anti-inflammatory, anti-diabetic, cardioprotective, and anti-cancer properties are only a few of the pharmacological actions of rutin. In this study, 24 Wister rats were used for 28 days. Rats were divided into four groups, group 1 was the normal control (reared on a normal diet), group 2 was the negative control (Streptozotocin; 55 mg/kg), group 3 was the reference group (metformin; 250 mg/kg) and group 4 was the treatment group (rutin; 15 mg/kg). The biochemical and histopathological investigations were used to evaluate the antidiabetic efficacy of the flavonoid compound rutin. The statistical analysis of variance (ANOVA) was conducted, and Tukey's test was used to establish the significance between the various groups. The study's findings showed that rutin improved glycemic and antioxidant status, which prevented streptozotocin-induced hyperglycemia. Of comparison to the negative control group, the physical parameters in the Rutin-treated rats were also noticeably improved. Rutin has restored the pancreatic beta cells' normal shape and active beta cell count, according to a histopathology study.

**Keywords:** Flavonoids, dietary flavonoids, type 2 diabetes, insulin signaling, Antioxidant, Cancer Cardiovascular diseases, Anti-inflammatory

**4TH INTERNATIONAL LATIN AMERICAN  
CONGRESS ON NATURAL AND APPLIED SCIENCES**

**PERI-IMPLANT MARGINAL BONE LOSS PROGRESSION AND A-MMP-8 CAN  
BE CONSIDERED AS INDICATORS OF THE SUBSEQUENT ONSET OF PERI-  
IMPLANTITIS. A 5-YEAR STUDY**

**Rodolfo Reda**

Department of Oral and Maxillofacial Sciences, Sapienza University of Rome, 00161 Rome,  
Italy; Private Periodontal Implant Practice, 31100 Treviso, Italy

**Renzo Guarnieri**

Department of Oral and Maxillofacial Sciences, Sapienza University of Rome, 00161 Rome,  
Italy; Private Periodontal Implant Practice, 31100 Treviso, Italy

**Alessio Zanza**

Department of Oral and Maxillofacial Sciences, Sapienza University of Rome, 00161 Rome,  
Italy; Private Periodontal Implant Practice, 31100 Treviso, Italy

**Marco Seracchiani**

Department of Oral and Maxillofacial Sciences, Sapienza University of Rome, 00161 Rome,  
Italy; Private Periodontal Implant Practice, 31100 Treviso, Italy

**Dario Di Nardo**

Department of Oral and Maxillofacial Sciences, Sapienza University of Rome, 00161 Rome,  
Italy; Private Periodontal Implant Practice, 31100 Treviso, Italy

**Luca Testarelli**

Department of Oral and Maxillofacial Sciences, Sapienza University of Rome, 00161 Rome,  
Italy; Private Periodontal Implant Practice, 31100 Treviso, Italy

**What is known:**

It has documented that dental implant with a high degree of early marginal bone (MBL) loss are likely to achieve additional increased MBL during function. Moreover, it has been speculated that an early increased MBL might be a predictive factor for the subsequent onset peri-implant inflammatory diseases.

**What this study adds:**

The present study showed that, after 5 years of function, implants with increased MBL rates at 6 months after loading are likely to achieve additional high values of MBL. No statistically significant relationship between MBL progression and the onset of peri-implantitis was found, whereas high MMP-8 levels, 6 months after loading, could have the distinct ability to predict the onset peri-implantitis.

**ABSTRACT**

The aim of this retrospective study was to investigate the relationship between the amount of early bone remodeling, the marginal bone loss (MBL) progression, and the peri-implant sulcular fluid concentration of active metalloproteinase-8 (a-MMP-8) and incidence of peri-implantitis during 5 years of implant function.

**4TH INTERNATIONAL LATIN AMERICAN  
CONGRESS ON NATURAL AND APPLIED SCIENCES**

**Materials and Methods:** Clinical and radiographic documentation at implant placement (T0), at restoration delivery (TR) at 6 months (T1), at 2- (T2) and at 5-years (T5) post-loading were retrospectively collected. MBL levels/rates (MBLr) and peri-implant sulcular fluid levels/rates of a-MMP-8 were assessed at TR, T1, T2, and T5. Implants were divided into two groups: group 1 with peri-implantitis (P+) and group 2 without peri-implantitis (P-). A multi-level simple binary logistic regression, using generalized estimation equations (GEE), was used to assess the association between each independent variable and P+. Receiver Operating Characteristics (ROC) curve was used to evaluate an optimal cut-off point of T1 MBL degree and a-MMP-8 level to discriminate between P+ and P- implants.

**Results:** A total of 80 patients receiving 80 implants [39 implants with a laser-microtextured collar surface (LMS) and 41 implants with a machined collar surface (MS)] were included. Periapical radiographs and a software package were used to measure MBL rates. Peri-implant sulcular Implant fluid samples were analyzed by a chairside mouth rinse test, (ImplantSafe<sup>®</sup>), in combination with a digital reader, (ORALyzer<sup>®</sup>). Twenty-four implants (6 with LMS, and 18 with MS) were classified with P+. No statistically significant association was found between the amount of early bone remodeling, MBL progression, MBLr, and incidence of peri-implantitis. Implants with a-MMP-8 levels >15.3 ng/mL at T1 presented significant influence on the probability of P+.

**Conclusion:** The amount of early. marginal bone remodeling cannot be considered as indicators of the subsequent onset of P+, whereas high a-MMP-8 levels, 6 months after loading, could have the distinct ability to predict P+.

**KEYWORDS:** Implants; MMP-8; Peri-Implantitis; Prognosis; Marginal Bone Loss; MBL; Periodontal Indices.



STURUCTURE TECHNIQUES USED IN EXAMPLES OF TRADITIONAL WOOD  
CIVIL ARCHITECTURE: TARAKLI HOUSES

GELENEKSEL AHŞAP SİVİL MİMARLIK ÖRNEKLERİNDE KULLANILAN YAPIM  
TEKNİKLERİ: TARAKLI EVLERİ

Özlem ÖZKAN ÖNÜR

DÜZCE ÜNİVERSİTESİ

ORCID NO: 0000-0002-4110-4936

**ÖZET**

Batı Karadeniz mimarisinin nitelikli örneklerini oluşturan Sakarya iline bağlı Taraklı ilçesi, iklimsel ve topografik özelliklerinin etkisiyle organik dokuda şekillenerek özgün dokusunu korumuş bir Osmanlı yerleşimidir. Orman alanlarının yoğun bulunduğu bölgede yer alması ahşap malzemenin kullanım amacını ortaya çıkarmıştır. Ahşap hafif, kolay işlenebilmesi ve taşınabilmesinden dolayı en çok tercih edilen yapı malzemeleri arasındadır. Aynı zamanda doğayla uyumluluğu, geri dönüşümünün kolaylığı, yüksek mukavemetli ve kullanım ömrünün uzun olması geleneksel Türk mimarisinde önemli yer tutar. Bu çalışmada, Taraklı'nın geleneksel mimarisinde kullanılan yapım teknikleri ve malzemesi incelenmiştir. Ahşap yapı duvarlarında uygulanan taşıyıcı sistemlerinin yük etkisi altında çalışma biçimine göre sınıflandırılması yapılmıştır. Düşey taşıyıcı olarak temel duvarları ve ahşap çatkılı duvarları, yatay taşıyıcı olarak tavan ve yer döşemeleri, yapı örtü sistemleri ve yapı elemanları hakkında bilgi verilerek, fotoğraflarla desteklenmiştir. Geleneksel sivil mimarlık örneklerinde kullanılan ahşap malzeme, ahşap yapılarda yapının omurgasını oluşturmaktadır. Bu nedenle ahşabın yapıda düşey ve yatay yüklere karşı dayanım göstermesi, şekil değiştirmemesi ve uzun süre ayakta kalması da yapı iskeletinin değerini belirleyen niteliklere bağlı olduğunu ortaya çıkarmıştır. Geleneksel mimarinin özgün niteliklerinin korunması, sürdürülebilirliği açısından yapılarda kullanılacak ahşap malzemenin özelliklerinin iyi bilinmesi ve tasarımının iyi yapılması gereklidir.

**Anahtar Kelimeler:** Ahşap Yapı, Düşey Taşıyıcı, Taraklı, Yatay Taşıyıcı.

## **ABSTRACT**

Taraklı district of Sakarya province, which constitutes qualified examples of West Black Sea architecture, is an Ottoman settlement that has preserved its original texture by being shaped in organic texture with the effect of climatic and topographic features. The fact that it is located in the region where forest areas are dense has revealed the purpose of use of wood material. Wood is among the most preferred building materials due to it is light, easy to process and transportable. At the same time, its compatibility with nature, ease of recycling, high strength and long service life have an important place in traditional Turkish architecture. In this study, the construction techniques and materials used in the traditional architecture of Taraklı were examined. The load bearing systems applied on wooden building walls have been classified according to the way they work under the influence of load. The load bearing systems applied on wooden building walls are classified according to the way working under the influence of load. By providing informations about foundation walls as vertical carriers and timber framed walls, structure cover systems and structure elements have been investigated and supported in which cases caused by deterioration was investigated and supported with photographs. The wood material used in traditional civil architecture examples forms the backbone of the structure in wooden structures. For this reason, it has been revealed that the woods of resistance to vertical and horizontal loads in the building, it is not deformation and long standing depend on the qualities that determine the value of the structure. In terms of the preservation and sustainability of the original qualities of traditional architecture, it is necessary to know the properties of the wood material to be used in the structures and to design it well.

**Keywords:** Wooden Structure, Vertical Carrier, Taraklı, Horizontal Carrier.

## **1. INTRODUCTION**

Taraklı district of Sakarya province, which constitutes qualified examples of West Black Sea architecture, is an Ottoman settlement that has preserved its original texture by being shaped in organic texture with the effect of climatic and topographic features.

The fact that it is located in the region where forest areas are dense has revealed the purpose of use of wood material. Wood is among the most preferred building materials due to it is light, easy to process and transportable. At the same time, its compatibility with nature, ease of recycling, high strength and long service life have an important place in traditional Turkish architecture. In this study, the construction techniques and materials used in the traditional architecture of Taraklı were examined. The load bearing systems applied on wooden building walls have been classified according to the way they work under the influence of load. Foundation walls and timber framed walls as vertical carriers, ceiling and floor coverings as horizontal carriers, building covering systems and building elements are provided and supported with photographs.

## **2. IN TRADITIONAL TARAKLI CIVIL ARCHITECTURE CONSTRUCTION TECHNIQUE**

Depending on the conditions of the region and the knowledge and skills of the craftsmen, different carrier systems were applied in the traditionally built wooden structures. Therefore, they are classified in different ways in terms of architecture and carrier. Depending on the load-bearing systems of wooden structures and the way they work under load,

### **2.1. Vertical Carriers**

#### **2.1.1. Foundation Walls**

The foundation walls of the buildings were made of rubble stones with mud mortar. The thickness of the foundation wall varies between 50-80 cm, and the height of the entrance floor varies between 2.5 m and 5 m. The garden floor continues outside the entrance facade. On the upper floors, the wooden pillow, which is placed on wooden blocks, is placed on the stone wall. As shown in Figure 1. rubble stone wall samples and in Figure 2. rubble stone foundation sample are given.



**Figure 1.** Examples of rubble stone foundation wall.



**Figure 2.** Example of rubble stone foundation.

### 2.1.2. Wooden Framed Walls

The filling of the wooden skeleton in traditional houses is mud brick. Vertical loads in buildings reach the foundation by transferring from the top log to the bottom with the contact of horizontally extending logs supported at their ends. As shown in the figure, an example of the wall detail of the wooden structure is given. Wooden pillows of 18/18 and 20/20 cm are first placed on the stone walls. The dimensions of the main pillars of the walls of the upper floor are 14/14, 16/16/ or 18/18cm square sections. As shown in the Figure 3. Examples of wall details are given.



**Figure 3.** Example of wall detail of wooden structure.

On wooden frame walls, the posts are placed at intervals of 1.20 - 1.50 meters in the dimensions of 15/15, 14/14, 12/12 at the corners, 12/12 and 10/10 inside. Intermediate struts are arranged 40 - 50 cm apart in the application of the framework element and filling products. Round or square cross-section buttresses are usually inserted into the struts at a 60° angle. In buildings with low floor heights, the pier angles are reduced to 45°. The main pillars are placed at 1.5-2 m intervals on the corners and window edges of the buildings. There are caps on the main headings. Struts and headings are joined to each other with nails. The second important part of the skeleton of the structures, after the pillars, is the buttresses. It is placed at an angle of 60° with the pillar by using it in different ways. The lengths of the buttresses are variable and they are formed from sections such as 8/12, 10/14 cm.

Plaster is applied in a different way on wooden frame walls filled with adobe. Plastering the straw-added mud plaster by applying directly to the surfaces. Thinner mud plaster application with flax tow and lime added. As shown in the Figure 4. It is the baghdadi plaster technique, which is applied on the laths, where thin boards, called Baghdadi, are nailed at intervals of 2.5-3.5 cm.





**Figure 4.** A Mud plastered application example of the facade of the building.

Wooden frame blocks filled with adobe in buildings are directly plastered on mud plaster with straw added on the inner and outer surfaces. As shown in the Figure 5. An Example of mud plastered application the facade of the building is given.



**Figure 5.** An Example of mud plastered application the facade of the building.

As shown in the Figure 6. An Example of the bagdadi plaster technique applied to the facade of the building is given. It is formed by the plaster mortar sticking to the surface by entering between the laths.





**Figure 6.** An Example of the bagdadi plaster technique.

The upper floor façade of the building is covered with a 2.5 cm thick solid wood, parallel to the wooden pads, on the surface of the wooden skeleton. As shown in the Figure 7. Examples of wooden covered facades are given.



**Figure 7.** Examples of wooden covered facades.

## 2.2. Horizontal Carriers

### 2.2.1. Floors

In wooden frame structures, carrier beams arranged in the same direction are applied in different sections and intervals, obtained from round or sawn wood, according to the load and span they carry. The spans of the carrier beams are 3.50 – 4.00 m and their spacing is 40 – 60 cm. As shown in the Figure 8. an example view of the installation of floor beams on a wooden base is given. The wooden beams forming the floor on the upper floors are 8/14, 10/15 cm in

**4TH INTERNATIONAL LATIN AMERICAN  
CONGRESS ON NATURAL AND APPLIED SCIENCES**

cross section and placed on the base at 1-2 m intervals. 3 cm thick, 20-30 cm wide woods are used for floor coverings. Boards, the length of which does not exceed 1 m, are nailed to the beams side by side without overlapping and passing through. As shown in the Figure 8. An Example of the wooden beams of the roof of the building and the tile underlayment is given.



**Figure 8.** Example of ceiling covering.

As shown in Figure 9. Example of various types of wooden ceiling coverings are given.



**Figure 9.** Examples of ceiling covering.

There are empty spaces on the ground floors, such as stony barns and warehouses, whose workmanship is not meticulous compared to other floors. The ground floors of the buildings generally were left as soil. As shown in the Figure 10. Examples of soil ground are given.

**4TH INTERNATIONAL LATIN AMERICAN  
CONGRESS ON NATURAL AND APPLIED SCIENCES**



**Figure 10.** Example of soil ground.

The floors of the upper floors of the buildings are usually wood coated. As shown in the Figure 11. Examples of wooden flooring are given.



**Figure 11.** Examples of wooden flooring.

### **2.2.2. Roofs**

In general, cradle roof type is encountered in houses with hipped roofs and outer and inner sofas in houses with middle sofa. As shown in the Figure 12. Examples of hipped roof and gable roof are given.



**Figure 12.** Examples of gable roof and hipped roof.



In all buildings, the cantilever distance of the eaves generally varies between 50 – 70 cm. They are made with and without motifs. As shown in Figure 13. Examples of eaves of the buildings are given.



**Figure 13.** Examples of eaves.

## **2.3. Structure elements**

### **2.3.1. Overhangs**

The overhangs of the buildings are usually formed by the 50-100 cm outward protrusion of the floor beams from the main walls. The console is designed with struts or bolstered overhangs. Cantilever overhangs are created by extending floor joists outward from the structure. As shown in Figure 14. Examples of overhangs of the buildings are given.



**Figure 14.** Example of overhangs.

The overhangs consisted of rooms or sofas. In order to enrich the sofa, provide a more comfortable place, and increase the upper floor area, overhangs were made. The wooden band is 30 cm wide, 250 cm long and 2 m high from the ground. The overhangs, which are generally parallel to the building surface, are designed by placing them on the whole facade, in the corners of the width of the room or in the middle of the facade as the width of the sofa.

## 4TH INTERNATIONAL LATIN AMERICAN CONGRESS ON NATURAL AND APPLIED SCIENCES

The overhangs are designed without support, with console support. Some overhangs in front of the sofa are arranged as balconies. As shown in the Figure 16. Example of overhangs is given.



**Figure 15.** Example of overhangs.

### 2.3.2. Doors

There are double-wing and single-wing wooden doors in historical buildings. Above them are open cages with iron bars above a window or door. There are double-wing and single-wing wooden doors in historical buildings. Above them are open cages with iron bars above a window or door. Double-wing doors are used at the main entrance. The dimensions of the exterior doors are 120-130 cm wide and 210-230 cm high. Single leaf doors are used indoors. Door openings are designed towards the interior of the space. As shown in the Figure 16. Examples of single and Figure 17. Example of double leaf doors are given.



Figure 16. Example of single leaf doors.



Figure 17. Examples of double doors.

### 2.3.3. Windows

Wooden windows are used in the buildings. There are ground floor windows on the thick stone wall. It has 40\*40, 60\*60, 90\*90 dimensions, with iron railing and glass. Window widths on the upper floors of wooden structures vary between 70-90 cm depending on the width. Their height is 170-180 cm and they are winged. According to the width of the surface where the number of windows is located, it was built in two different ways as flat lintel and arched. flat lintel windows; should be divided into two and three. In three-paned windows, upper and middle wings are fixed, lower wings are opened. In two-paned windows, the upper wing is fixed and the lower wings are opened. As shown in the Figure 18. Examples of flat lintel windows are given.





**Figure 18.** Examples of flat of lintel windows.

Arched windows have two or three panes. This type of windows is used in sofas and iwans in order to give the facades an aesthetic appearance. The most important feature of arched windows is the arched shape of the lintel. But its details are similar to other window types. As shown in the Figure 19. Example of arched windows is given.



**Figure 19.** Example of arched windows.

### **3. RESULT**

The wood material used in traditional civil architecture examples forms the backbone of the structure in wooden structures. For this reason, it has been revealed that the wood's resistance to vertical and horizontal loads in the building, its non-deformation and long standing depend on the qualities that determine the value of the structure.

In terms of the preservation and sustainability of the original qualities of traditional architecture, it is necessary to know the properties of the wood material to be used in the buildings and to design it well.

### **REFERENCES**

Ahunbay, Z. (1998). *Tarihi Çevre Koruma ve Restorasyon*, Yapı Yayın, İstanbul.

Ersen, N. ( 2000). *Ahsap Yapılar Problem ve Çözümleri*, Birsen Yayın Evi, İstanbul.

**4TH INTERNATIONAL LATIN AMERICAN  
CONGRESS ON NATURAL AND APPLIED SCIENCES**

Günay, R. (2002). *Geleneksel Ahsap Yapılar Sorunları ve Çözüm Yolları*, Birsen Yayınevi, İstanbul, 2002.

Özkan, Ö. (2009). Taraklı Sivil Mimarlık Örnekleri ile Halim Düzgün Evi'nin Proje ve Ali Pektaş Evi'nin Restorasyon Çalışmaları, Yüksek Lisans Tezi, Sakarya Üniversitesi, Fen Bilimleri Enstitüsü, Sakarya.

Özkan Önür Ö. & Yerli, Ö. (2019). *Sivil mimarlık örneklerinden Ayşe Sezgin Evi'nin restorasyonu*. Mimarlık, Planlama ve Tasarım Alanında Araştırma Makaleleri, (ss.201-219).

Özkan Önür, Ö., Apay, A. C. & Mutlu, E. (2022). Tarihi Yapılarda Koruma Fatma Sevim Dönmez Evi. *Kültürel Miras Araştırmaları Dergisi*, c.3, v.1, 17–25.

Seymen, F. (2008). Taraklı'da Geleneksel Sivil Mimaride Kullanılan Yapım Teknikleri ve Sadık Özen Evi Önerisi, Yüksek Lisans Tezi, Yıldız Teknik Üniversitesi, Fen Bilimleri Enstitüsü, İstanbul.

Taraklı Belediye Arşivi.

**HOLISTIC ANALYSIS OF NURSING COMPETENCE OF NURSES**

**HEMŞİRELERİN HEMŞİRELİK YETERLİKLERİNİN BÜTÜNCÜL OLARAK  
İNCELENMESİ**

**Selen Tekin**

Bandırma Onyedi Eylül Üniversitesi Sağlık Bilimleri Enstitüsü Hemşirelikte Yönetim  
Doktora Programı, Doktora Öğrencisi, Bandırma, Türkiye.

ORCID ID: <https://orcid.org/0000-0002-4207-0272>.

**Ayşe Çiçek Korkmaz**

Bandırma Onyedi Eylül Üniversitesi Sağlık Bilimleri Fakültesi Hemşirelikte Yönetim  
Anabilim Dalı, Dr. Öğretim Üyesi, Bandırma, Türkiye.

ORCID ID: <https://orcid.org/0000-0001-8184-1490>.

**ÖZET**

Bütüncül hemşirelik güvenli, profesyonel, etik ve kaliteli hemşirelik bakımı sağlamanın eksiksiz bir yoludur. Hemşirelik yeterliği kaliteli, etik değerlere uygun ve güvenli hasta bakımına odaklanmayı gerektirir. Bütüncül hemşirelik yeterliği ve buna dayalı hizmet sunumu ile kaliteli, güvenli ve bütüncül hasta bakımı sağlanacaktır. Bu araştırma hemşirelerinin bütüncül hemşirelik yeterliklerinin incelenmesi amacıyla tanımlayıcı olarak gerçekleştirilmiştir. Çalışmanın örneklemini, basit rastgele örnekleme yöntemi ile araştırmaya alınma ölçütlerini karşılayan 192 hemşire oluşturmuştur. Veriler sosyo-demografik özelliklerin yer aldığı Tanıtıcı Bilgi Formu ve Bütüncül Hemşirelik Yeterlik Ölçeği (BHYÖ) kullanılarak toplanmıştır. Verilerin değerlendirilmesinde tanımlayıcı istatistikler (yüzde, frekans, ortalama, standart sapma, minimum, maksimum), Cronbach alfa katsayısı, t-testi, Mann Whitney U testi, ANOVA testleri ve posthoc analizler (Tukey, LSD, Games-Howell) kullanılmıştır. Bu çalışmada hemşirelerin yaş ortalaması  $35,45 \pm 9,12$  arasında olup %91,7'si kadın, %62'si evlidir. BHYÖ ölçeği toplam puan ortalamaları  $6,17 \pm 0,59$  olarak bulunmuştur.

## 4TH INTERNATIONAL LATIN AMERICAN CONGRESS ON NATURAL AND APPLIED SCIENCES

Çalışma sonucunda yaş ve medeni durum değişkeni ile mesleki gelişim alt boyutu; mezun olunan okul değişkeni ile genel yetenek hariç tüm alt boyut ve ölçek toplam puan; çalışılan bölüm değişkeni ile personel eğitimi-yönetimi ve etik odaklı uygulamalar alt boyutları; hemşirelik yılı değişkeni ile mesleki gelişim alt boyutu; çalışma yılı değişkeni ile mesleki gelişim ve ölçek toplam puan; çalışma pozisyonu değişkeni ile genel yetenek, personel eğitimi-yönetimi ve ölçek toplam puan; birim memnuniyeti ve iş arkadaşlarından memnun olma değişkenleri ile etik odaklı uygulama ve ekipte hemşirelik bakımı alt boyutları; ayrıca birim memnuniyeti ile ölçek toplam puan; mesleği sevme değişkeni ile etik odaklı uygulama alt boyut puan ortalamaları arasında istatistiki açıdan anlamlı fark saptanmıştır ( $p<0,05$ ,  $p<0,01$ ). Mevcut çalışmada yaş, medeni durum, çalışma süresi ve hemşirelikte geçirilen sürenin mesleki gelişimi etkilediği, mesleği sevme ile çalışılan birim ve çalışma arkadaşlarından memnun olma durumunun etik odaklı uygulamaları artırdığı, ayrıca birimi ve çalışma arkadaşlarından memnun olmanın ekip halinde hemşirelik bakım yeterliliğini artırdığı, eğitim seviyesinin mesleki gelişim yeterliliği yönetimini sağlamanın yanı sıra etik uygulamaları ve ekip halinde hemşirelik bakım yeterliliğini artırdığı ve son olarak çalışılan birimin etik uygulamalara yönelme ve personel eğitimi alanlarında etkili olduğu sonucuna erişilmiştir. Hasta güvenliği ve kaliteli bakım çıktılarında erişimin tek yolunun bütüncül bakım anlayışı ile hemşirelik yeterliliğinin birbirini bütüncül bir oluşumdan kaynaklı olduğu ve önemi fark edilmelidir.

**Anahtar Kelimeler:** Hemşirelik Yeterliliği, Yeterlilik, Hemşirelik, Mesleki Yeterlilik, Bütüncül Bakım

### ABSTRACT

Holistic nursing is a complete method of ensuring safe, professional, ethical, and quality nursing care. Nursing competence requires focusing on quality and safe patient care in line with ethical values. Quality, safe, and holistic patient care can be provided through holistic nursing competence and provision of services based on this. The study was conducted as descriptive research in order to examine holistic nursing competences of nurses. The study sample consisted of 192 nurses selected through simple random sampling method who met the inclusion criteria. The study data were collected through Identifying Information Form which inquired about sociodemographic characteristics and Holistic Nursing Competence Scale (HNCS). In the evaluation of the data, descriptive statistics (percentage, frequency, mean, standard deviation, minimum, maximum), Cronbach's alpha coefficient, t test, Mann-Whitney U test, ANOVA test, and post hoc analyses (Tukey, LSD, Games-Howell) were used. In the study, it was determined that the mean age of the nurses was  $35.45\pm 9.12$  years, 91.7% were female, and 62% were married. HNCS total scale mean score of the nurses was found as  $6.17\pm 0.59$ . As a result of the study, statistically significant differences were determined between age and marital status variable and professional development subscale, between the variable of school of graduation and all subscales except general ability subscale and total scale score, between the variable of unit of service and the subscales of personnel training-management and ethics-oriented applications, between the variable of year of nursing

**4TH INTERNATIONAL LATIN AMERICAN  
CONGRESS ON NATURAL AND APPLIED SCIENCES**

service and the subscale of professional development, between the variable of year of working and professional development and total scale score, between the variable of working position and general ability, personnel training-management, and total scale score, between satisfaction with the unit of working and satisfaction with colleagues variables and the subscales of ethics-oriented applications and nursing care as a team, between satisfaction with the unit of working and total scale score, and between the variable of loving the profession and ethics-oriented applications subscale mean scores ( $p < 0.05$ ;  $p < 0.01$ ). In the study, it was found that age, marital status, working year, and nursing service year affected professional development, that loving the profession and satisfaction with the unit of working and colleagues increased ethics-oriented applications, that satisfaction with the unit and colleagues increased nursing care competence as a team, that educational level increased ensuring professional development competence management as well as ethical applications and nursing care competence as a team, and that the unit of working was effective on orientation towards ethical applications and personnel training. It should be noted that ensuring patient safety and achieving quality care outcomes are only possible through an understanding of holistic care, and that nursing competence consists of elements complementing one another.

**Keywords:** Nursing Competence, Competence, Nursing, Professional Competence, Holistic Care.

**MILK PRODUCTION IN ACCORDANCE WITH THE PRINCIPLES OF  
SUSTAINABLE DEVELOPMENT: THE CASE OF FARM "KOJIĆ"**

**Dr. Milena Milojević**

**PhD student Suzana Knežević**

**Dr. Biljana Delić Vujanović**

**Dr. Goran Stanišić**

Academy of Vocational Studies Šabac, Unit of Agricultural and Business Studies and  
Tourism

ORCID NO: 0000-0001-6997-1537

**ABSTRACT**

The breeding of dairy cows in Serbia has a downward trend primarily due to the reduction of livestock and the low purchase price of milk. There is a large imbalance in the purchase price of milk and the price of processed milk and milk products. Family farms usually contract the purchase of milk with large production chains in order to have a secure market and a constant source of cash income. In this paper, the production of milk on the private farm "Kojić" from Dvorište is analyzed, where a combination of modern farming principles and semi-intensive breeding of dairy cows results in larger quantities of milk and greater welfare of the animals. Such a concept of farm organization contributes to the fulfillment of the goals of sustainable development, since it ensures greater economic profit, provides a permanent job to the owners with the possibility of employment and additional workers, and semi-extensive cow breeding contributes to the preservation of indigenous species and environmental protection. The work is structured to include general data about the farm, the average age of cows in the pasture and the number of calves, the amount of milk sold and the analysis of the results with accompanying conclusions.

**Keywords:** milk production, sustainable development, farm "Kojić".



**SATELLITE MUSEUMS AND ITS IMPACTS ON URBAN SPACE**

UYDU MÜZELER VE KENTSEL MEKANA ETKİLERİ ÜZERİNE BİR İNCELEME

**Ceren AĞIN GÖZÜKIZIL**

Ar.Gör.Dr., Muş Alparslan Üniversitesi

ORCID NO: 0000-0002-2032-4921

**Senem TEZCAN**

Dr., İstanbul Büyükşehir Belediyesi

ORCID NO: 0000-0003-0532-8825

**ÖZET**

Kentler, küreselleşmenin baskın bir akım olarak kentleri biçimlendirdiği 1980 sonrası dönemde birbirleriyle rekabet içerisine girmişlerdir. Bu yarışmacı süreç kentleri kendi, markalarını yaratmaya, olumlu yönlerini öne çıkarmaya yönelik uygulamalar yaparken olumsuzluklarını bertaraf etmeye, tehditleri ortadan kaldıracak ve potansiyellerini maksimum seviyede kullanabilecek stratejiler yaratmaya itmiştir. Her kent daha zengin turist ve yatırımcıyı kentine çekmeyi istemektedir. Özellikle hizmet sektörünün ekonomik pay dağılımındaki artan oranı turistik faaliyetlerden biri olan kültür eksenli küresel hareketliliği de öne çıkarmıştır. Organizasyon ve etkinliklere ev sahipliği yapmak önemsenen bir strateji haline gelmiştir. Bu etkinlikler süreli veya süresiz şeklinde gruplanmaktadır. Müzeler ve özellikle tematik nitelikte olanlar gerek mimarisıyla gerekse sergiledikleri ürünlerle kendileri birer çekim noktası haline gelmişlerdir. Müzeler nitelik olarak farklı gruplara ayrılmaktadır. Bunların buldukları kente etkileri bulunmaktadır. Ancak bu çalışma son dönemlerde daha da görünür olan ve dünya çapında da birçok örneklerini gördüğümüz uydu müzelerle odaklanmaktadır. Yirmi birinci yüzyılın bu yeni uydu modelinde merkez müzeler sahip oldukları eserleri farklı kent veya ülkedeki uydu müzelerle aktarmaktadır. Böylesi bir akışta asıl müzenin bilinirliği artmakta; uydu müzeler ise buldukları kent parçasında birer öncü proje özelliği ile çevresini dönüştürmektedir. Çalışma kentlerin markalaşması bakış açısından başlayarak bir pazarlama stratejisi olarak müzeleri ve uydu müzeleri tanımlamayı ve bu tip yapıların kentsel mekanlar üzerindeki etkilerini kuramsal çerçeve ve dünya örnekleri üzerinden ortaya çıkarmayı amaçlamaktadır.

**Anahtar Kelimeler:** Müze, Uydu Müze, Turizm, Küreselleşme

## **ABSTRACT**

Cities entered into competition with one another in the post-1980 period, when globalization shaped cities as a dominant trend. This competitive process has pushed cities to create their brands, eliminate their negative aspects, create strategies that will eliminate threats, and use their potential at the maximum level while making practices to highlight their positive aspects. Every city wants to attract richer tourists and investors to its city. In particular, the increasing rate of the service sector in the economic share distribution has also highlighted cultural-oriented global mobility, which is one of the touristic activities. Hosting organizations and events has become an important strategy. These activities are grouped as temporary or indefinite. Timed events have the power to influence the economy and the global media. These events, which are generally designed in a competitive framework, are the events that develop tourism, provide media coverage and have economic effects such as the Olympic Games, Paralympic Games, FIFA World Cup, and World Athletics Championship, being the Capital of Culture, Festivals, Biennials, Fairs, and World Fairs. While increasing the awareness of the cities, strengthens the brand value of the cities; their size in terms of scale enables the rapid realization of urban investments. Indefinite organizations, on the other hand, are landmarks with particularly iconic structures, created within a specific theme. Iconic Buildings, Theme Parks, Science centers, R&D Centers, Technoparks, and Museums are examples of this. Museums, especially the thematic ones, have become points of attraction with their architecture and the products they exhibit. Museums are also divided into different groups. These have effects on the city in which they are located. However, this study focuses on satellite museums, which have become more visible in recent years and we see many examples around the world. In this new satellite model of the twenty-first century, central museums transfer their works to satellite museums in different cities or countries. In such a flow, the awareness of the original museum increases; Satellite museums, on the other hand, transform their surroundings with the characteristics of pioneering projects in the part of the city they are located in. The study aims to define museums and satellite museums as a marketing strategy, starting from the point of view of the branding of cities, and to reveal the effects of such structures on urban spaces through a theoretical framework and world examples. The study aims to present this aim by making an evaluation of the satellite museums of the Guggenheim and Louvre Museums, which are two important museums.

**Keywords:** Museum, Satellite Museum, Tourism, Globalization

## **GİRİŞ**

Kentler, 1980 sonrasında küreselleşmenin ve yerelleşmenin kentsel strateji üretimindeki baskın etkisi ile aynı networkü paylaştığı diğer kentlerle rekabet içerisine girmişlerdir. Bu yarışmacı sürecin etkisiyle kentler kendi, markalarını yaratmaya, olumlu yönlerini öne çıkarmaya yönelik uygulamalar yaparken olumsuzluklarını bertaraf etmeye, tehditleri ortadan kaldıracak ve potansiyellerini maksimum seviyede kullanabilecek girişimler içerisine girmişlerdir. Kentler, daha zengin turist ve yatırımcıyı kentine çekmeyi isterken ismini ve kentsel öğelerini uluslararası arenada duyurmaya çalışmaktadır. Hizmet sektörünün ekonomik

pay dağılımındaki artan oranı turistik faaliyetlerden biri olan kültür eksenli küresel hareketliliği öne çıkarmıştır. Hatırlanabilirliklerini arttırmak için küresel unvana sahip olmak önemli hale gelmiştir. Bunu yaratmada küresel mega etkinliklere ev sahipliği yapmak veya ikonik yapılar ile birlikte kültür eksenli organizasyonlara sahip olmak öne çıkmıştır. Müzeler, kentsel imajın güçlendirilmesinde önemli unsurlardan biri olmuştur. Bunu sahip olunan kültürel ve yerel değerleri sunmak ile sağlamlarken kentler dünya çapında ünlü müzelerin birer uydusunun kendi kentlerinde yer almasını sağlamak da uygulamalardan biri haline gelmiştir. Özellikle Guggenheim Bilbao Müzesinin tetikleyici bir proje olarak başardıkları kent literatürüne “Bilbao Etkisini” kazandırmış ve ardından birçok kent landmark niteliğindeki yapılar ve onun kent mekanı üzerinde yarattığı etkilerin bir benzerini oluşturmak için çeşitli projeler geliştirmiştir. Çalışma küreselleşmenin yarattığı bu ortam içerisinde uydu müzeler yoluyla markalaşmayı ve kent mekanına etkilerini Guggenheim ve Louvre uydu müzeleri üzerinden açıklamayı hedeflemektedir.

### **1. Süreli/Süresiz Organizasyonlar ve Kent Markalaşması**

Rekabetçi küresel ağlarda kentler şehrin sakinleri, yatırımcılar ve ziyaretçiler için daha çekici hale getirilebilmek için belirli bir pazarlama politikasına ihtiyaç duymaktadır. Markalaşma ile yapılmak istenen kente gelen ziyaretçiler özelinde kent algısının şekillendirilmesidir. İmaj ve algı yönetimi ile birlikte bir yerin markalaşması bir dizi stratejiyi içermektedir. Kentler ayırt edici, ilgi çekici ve kente dair olumlu nitelikleri ön plana çıkaran kentin tarihi, kültürel ve mimari niteliklerini kullanmaktadırlar. Bu durum, 1970’lerden itibaren yükselen “gösteri toplumu”nun da bir devamı niteliğindedir. Mimarının de dahil olduğu bu gösteride birer kent markası ikonu haline gelmektedir. Simgesel bu imajlar kentlerin rekabetçi stratejilerinden de birini oluşturmaktadır (Deffner ve Labrianidis, 2005; Uysal, 2014; Ye ve Björner, 2018; Kayın, 2003; Tezcan, 2011). Süreli ya da süresiz etkinliklere ev sahipliği yapmak, sadece kısa vadeli turist çekimi için değil, aynı zamanda destinasyon imajını geliştirmek ve bunu sürdürülebilir kılmak için de önemlidir (Yu vd., 2012).

Destinasyonların organizasyonlar aracılığıyla çekim merkezi olma isteklerinin nedenleri şu şekilde sıralanabilir (Can, 2015): (1) Turizmin düşük olduğu dönemlerde kente ziyaretçi çekmek. (2) Ziyaretçilerin kentte kalma sürelerini arttırmak. (3) Yer in imajını yaratmak. (4) Altyapının iyileştirmesi konusunda süreleri hızlandırmak ve daha fazla yatırımın yapılmasını sağlamak. (5) Bir yer in sahip olduğu olanaklardan daha verimli bir şekilde faydalanmak. Kültür bu anlamda kilit bir rol oynamaktadır.

Kültür, bir kentin kimliğini güçlendirdiği düşünüldüğünde bir yer in markalaşmasında iki unsur öne çıkmaktadır. İlki bir kent imajının markalaşma için önemi ve onu etkileme gücü; ikincisi ise kentin markasının kentin kimliğine olan yoğun bağımlılığıdır. Bu durum kültürü katma değeri olan bir unsura dönüştürmektedir. Bir yaratıcılık kapısı olarak kültür, yeni ve modern olanı ziyaretçilere aktarmak açısından önemli hale gelmektedir. Kent politikalarında kültür ise özellikle 1980’lerden sonra anahtar bir kelime olarak etkinliklere ev sahipliği yapmasına ve Kültür Başkenti gibi etiketlere sahip olma isteğine katkı sunmuştur. Kültürel planlamanın olası hedeflerinden biri ayırt edici olaylardır. Bunlar, destinasyonun

## 4TH INTERNATIONAL LATIN AMERICAN CONGRESS ON NATURAL AND APPLIED SCIENCES

pazarlanması, vizyon ifadesi, marka imajı ve yaratıcı ortam için önemli birer tetikleyicidir. Postmodern kültürün birer parçası niteliğindeki projeler büyük ölçekli, yüksek ve seçkin bir kültürel yapıya sahip, anıtsallık özelliği taşıyan ve uluslararası turistler için cazibeli niteliğe sahip olmalıdır (Dragolea ve Cotırlea, 2012; Deffner ve Labrianidis, 2005; Karaca, 2012).

Kültürel ürünler bir destinasyonun markalaşmasında önemli birer unsurdur. Kültür aracılığıyla markalaşmada dört önemli strateji öne çıkmaktadır (Timur vd., 2016): (1) ikonik ve landmark niteliğindeki yapılar (2) tema oluşturma (3) miras madenciliği ve (4) küresel mega etkinliklerdir. Bu anlamda kentlerin markalaşması ile süreli ve süresiz organizasyonlar açısından ele alınması önemlidir.

Süreli organizasyonlar olan mega etkinlikler bir yerin ekonomisini ve küresel medyanın ilgisinin üzerinde olduğu dönemler olması neticesinde tanıtımını ve bilinirliğini etkileme gücüne sahiplerdir. Destinasyon pazarlamanın yeni imaj oluşturucusu olarak önemli bir içsel bileşeni olan bu etkinlikler kentlerin ekonomik ve mekânsal gelişimlerini hızlandırmakta; tanıtımına katkı sağlamaktadır. Rekabet avantajı sağlayan bu unsurlar, kentlerin gelişim stratejilerindeki hedeflerini ulaşmasına etki ederek, organizasyonların getirdikleri başarının kentin tanıtım, ekonomi ve yapıyı çevresine katkı sağladığı ileri sürülmektedir. Ulusal ve uluslararası fuarlar, EXPO, kültür başkenti, büyük ölçekli spor organizasyonları, olimpiyat oyunları, dünya ve Avrupa şampiyonaları, Formula 1, festivaller, bienaller, kongre ve toplantılar, sergiler, dünya atletizm şampiyonası gibi etkinlikler küresel bağlamlı süreli organizasyonlardır (Deffner ve Labrianidis, 2005; İnce Kompil ve Kompil, 2012; Can, 2015; Timur vd., 2016; Gökçen Dünder, 2010; Karaca, 2012).

Süresiz organizasyonlar ise daha çok landmark oluşturma ve ikonik mimari öğelerle ilişkili olması açısından kent markası üzerinde etki yaratmaktadır. Bir kentin kimliği üzerinde sembolik birer imge yaratılarak kentlerin farklılaşmasını sağlamaktadır. Anıtsal ve kolay tanınabilir öğeleri içeren bu yapılar ziyaretçiler için birer fiziksel gösterge veya bir yerin tarihi ve yerel değerlerine işaret eden ve bunları belirginleştiren unsurlar haline gelmişlerdir. İkonik yapılar tek başına bu simgeleri oluşturabildiği gibi temaparklar, bilim merkezleri, Ar-Ge merkezleri, teknoparklar ve müzeler hem kendi içerikleri ile hem de özellikle son dönemde artarak yapılarının landmark nitelikleri ile ziyaretçileri etkilemektedir (Timur vd., 2016, Tezcan, 2011; Gökçen Dünder, 2010; Karaca, 2012) (Tablo 1).

**4TH INTERNATIONAL LATIN AMERICAN  
CONGRESS ON NATURAL AND APPLIED SCIENCES**

Tablo 1. Süreli ve Süresiz Organizasyonlar

Süreli Organizasyonlar	Süresiz Organizasyonlar
<u>Ulusal ve Uluslararası Fuarlar</u> EXPO Kültür Başkenti	İkonik Yapılar Temaparklar Bilim Merkezi
<u>Büyük Ölçekli Spor Organizasyonları</u> Olimpiyat Oyunları Dünya ve Avrupa Şampiyonaları Formula 1 Universiade	Ar-Ge Merkezleri Teknoparklar Müzeler
<u>Uluslararası Kültür Etkinlikleri</u> Festivaller Bienaller Kongre ve Toplantılar Sergiler	

Kaynak: Gökçen Dündar, 2010; Karaca, 2012

### 1.1. Süreli Organizasyonlar

Belirli tarihlerde tekrarlanan, belirli bir zaman diliminde gerçekleştirilen ve ziyaretçilerin katılımına açık olan etkinliklerdir. Aynı yerde düzenli olarak gerçekleştirilebileceği gibi her bir etkinlik başka bir yerde düzenlenebilmektedir. Kısa süreli olmalarına rağmen özellikle küresel mega etkinlikler medyada yer alma süresini ve biçimini etkilemesi dolayısıyla bir yerin tanıtımına, olumlu imaj yaratılmasına, yoğun bir ziyaretçinin katılımının olmasına katkı sunmaktadır. Büyük ölçekli organizasyonların etkileri az gelişmiş ve gelişmekte olan ülkeler için dönüşüm, değişim ve altyapı çalışmaları için; gelişmiş ülkeler için özellikle itibar kazandırmak açısından bir fırsat sunmaktadır (Tezcan, 2011).

### 1.2. Süresiz Organizasyonlar

Belli bir konuyu içeren ve bu konuya yönelik çalışmaların yanı sıra kent için de bir cazibe noktası olan merkezlerdir. Bu organizasyonlarla hedeflenen kente gelen ziyaretçi sayısını arttırmak, yerel ekonomide canlandırma sağlamak, yerinde deneyim sunarak kent imajını güçlendirmek ve yerel değerlerini ön plana çıkararak küresel alanda itibar kazanmaktır. Süreli organizasyonlar kentsel alanlarda sundukları ve mimari özellikleri ile birer çekim noktası yaratmaktadırlar. Müzeler, tiyatro ve konser salonları ve sanat merkezleri gibi kültürel kurumlar, kentlerin çağdaş "post-endüstriyel dönüşümü"nin ikonları haline gelmişlerdir. Bunlardan özellikle müzeler bir destinasyonun markalaşması ve birer kültürel cazibe merkezi olmaları nedeniyle kentsel gelişim alanlarında öncü projeler niteliği taşımaktadırlar. Projeci bir yaklaşımla hedeflenen daha fazla yatırım ve turisti kentlere çekmektir. Kentsel kimlik ve formun markalaşması sürecinde kamusal alanlar, parklar, simge yapılar, kütüphaneler, müzeler ve modern caddeler öne çıkmaktadır (Tezcan, 2011; Pasquinelli, 2017; Günay, 2018; Hazime, 2011; Rehan, 2013). Küresel ölçekli bir sanat müzesi aşağıdaki gibi karakterize edilebilmektedir (Hazime, 2011):

- Küresel medyada ve iletişim kanallarında görünürlüğünün artması,
- Bir süperstar olarak tanımlanabilecek mimarlar tarafından tasarlanan mimari yapı,
- Rekor kıran büyük sergilere ev sahipliği yapmak ve bunlara gelen yüksek ziyaretçi sayıları,
- Turistler için çekim noktası olmak,
- Büyük sermaye maliyeti yatırımları ve işletme bütçeleri gerektirmesi,
- Pahalı reklam ve ticarileştirme stratejileri kullanmak,
- Büyük bir operasyonel riske sahip olmak,
- Yerel ekonomi üzerinde önemli bir etki için bir beklentinin oluşması.

## **2. Uydu Müzeler**

Kültürel cazibe merkezleri arasında müzeler, önemli ekonomik getiriler sağlayan ve kentsel alanlar için öncü niteliği taşıyan kentsel gelişim stratejilerinden biri haline gelmişlerdir. Müzeler, sadece eser barındıran ve bunu ziyaretçilere sunan birer yapı olmaktan çıkarak özellikle “akademik imaj”, “kültürel ve tarihi miras” gibi kent markasını güçlendiren öğeler içermektedir (Hazime, 2011; Trabskaia vd., 2019). Diğer taraftan müzeler, kent markalaşmasında sıklıkla kullanılan mimari simgeler, ikonik yapılar ve landmarklar gibi yapıların üretilmesinde de önemli fırsatlar sunmaktadır. Mimarlık, kentin markalaşmasında katalizör bir rol üstlenmektedir. Kentler arasındaki rekabette farklılık yaratmakta, ayırt edilebilir imaj oluşturmada ve kentsel mekânın kalitesini iyileştirmektedir. Hedef kitlenin zihninde olumlu imaj oluşturmak önemli hale gelmiştir. Özellikle bilinen mimarlarca yapılan tasarımlar kentsel gelişme ve dönüşüm için tetikleyici bir unsur olarak kendine yer bulmaktadır (Muratovski, 2012; Peker, 2006; Castillo-Villar, 2016; Altınbaşak ve Yalçın, 2009).

Bugün uydu müzeler, buradan hareketle, kentlerin kendilerine çekmek istediği yatırımlardan biri haline gelmiştir. Tate Modern, British Museum, Guggenheim ve Louvre gibi kendileri birer marka olan müzelerin sergilerinin sunulduğu, ünlü mimarlarca tasarlanan ikonik yapılarıyla uydu müzeler, markalaşmak isteyen kentlerin öncü projeleri haline gelmişlerdir (Trabskaia vd., 2019). Müzeler şu sebeplerden ötürü uydu müzelerin yaratımına istekli olmuşlardır (Çevik, 2021; Pascal International Exchange, b.t.): (1) Müzelerdeki eserlerin büyük çoğunluğunun sergilenmeyerek depolarda tutulması. (2) Müze depolarının dolması. (3) Depoların her zaman yeterli koruma şartlarını sağlayamaması. (4) Depodaki eserlerden ziyaretçilerin faydalanamaması. (5) Müzeye sahip olmayan yerleşimlerin bunlara sahip olması (6) Eserleri insanlara götürmek. (7) Turizmi ve bölge ekonomisini canlandırmak. (8) Sosyo-ekonomik anlamda daha geniş bir kitleye ulaşmak. (9) Koleksiyonlarına ve üretimlerine erişimi artırmak. (10) Kendi markasını güçlendirmek.

Bu durumda Guggenheim Müzesinin uydusu olan Bilbao Guggenheim Müzesi önemli bir örnek olmuştur. Amerikalı mimar Frank Gehry tarafından tasarlanan müze, eski bir tersane olan ancak daha sonra çöküntü alanı oluşturan Bilbao kentinde inşa edilmiş; bölgede kentsel gelişim ve turizm alanında olumlu bir etki yaratmıştır. Hatta bu durum, planlama literatürüne “Bilbao etkisi” kavramını kazandırmıştır. Müzenin ardından kentte birçok yapı ünlü mimarlar



## 4TH INTERNATIONAL LATIN AMERICAN CONGRESS ON NATURAL AND APPLIED SCIENCES

tarafından tasarlanmış ve kültürel bir bölge halini almıştır (Deffner ve Labrianidis, 2005; Riza vd., 2012; Castillo-Villar, 2016; Pasquinelli, 2017; Hazime, 2011). Louvre Müzesi de benzer bir amaçla kendi uydu müzelerini veya sergilerini kentlerdeki önemli müzelerde sergileyerek benzer bir etki yaratmaya çalışmıştır. Bunu daha fazla ziyaretçiden daha çok, daha iyi ziyaret koşullarının sağlanması şeklinde nitelendirmişlerdir (Çevik, 2021; Riza vd., 2012) (Şekil 1).



Şekil 1. Guggenheim ve Louvre Müzelerinin konumları

### 2.1. Guggenheim Müzesi

Guggenheim'in New York, Venedik, Bilbao kentlerinde aktif olarak hizmet sunan ve Abu Dabi'de yapım aşamasında olan dört farklı kentte müzeleri bulunmaktadır (Şekil 2).

## 4TH INTERNATIONAL LATIN AMERICAN CONGRESS ON NATURAL AND APPLIED SCIENCES



Şekil 2. Guggenheim Müzelerinin konumları

### 2.1.1. Solomon R. Guggenheim Müzesi (New York-ABD)

New York kentinde bulunan Solomon R. Guggenheim Müzesi, mimar Frank Lloyd Wright tarafından tasarlanmıştır. 1943-1959 yılları arasında inşa edilen yapı, organik ve kıvrımlı şekliyle bulunduğu bölgeden ayrılmaktadır ve bu yapıyı ayırt edici ve fark edilir kılmaktadır (Arkitektuel, 2023a). Eğitim, sergiler ve koleksiyonlara sahip olan müze, ödül törenleri ve geçici sergileriyle öne çıkmakta ve faaliyetlerinde ziyaretçilerin ilgisini çekme yönünde faaliyetler gerçekleştirmektedir (Özrili, 2020; Gökçe, 2014).

### 2.1.2. Bilbao Guggenheim Müzesi (Bilbao-İspanya)

Mimar Frank Gehry tarafından tasarlanan müze 1997 yılında yapılmıştır. Dekonstrüktivist mimarinin öncü tasarımlarından biri olması nedeniyle sergilenen ürünler kadar yapısı ile de dikkat çekmektedir. Eğilimli yüzeylerinde titanyum, cam ve kireçtaşı kullanılan yapı, bu anıtsal görünümü ile birlikte mimar tarafından çevresiyle ve yarattığı kamusal alanları kent dokusuyla ilişkilendirerek kentle güçlü bir iletişimin kurulmasına da özen göstermiştir (Arkitektuel, 2023b).

### 2.1.3. Venedik Peggy Guggenheim Müzesi (Venedik-İtalya)

1948'de Penny Guggenheim resim koleksiyonunu saklamak ve sergilemek için aldığı Venier Sarayı'nı 1979 yılına kadar ev-müze şeklinde halka ücretsiz olarak açmıştır. Pollock, Warhol, Magritte, Dalí, Picasso, Fontana, Rothko, Marini gibi önemli çağdaş sanatçıların resimlerinin olduğu bir koleksiyon sergilenmektedir. Müzenin düzenlendiği etkinlikler bulunmaktadır ve herkes için erişilebilir ve kapsayıcı bir müze olmaya çalışmıştır. Serginin binası olan Venier

## 4TH INTERNATIONAL LATIN AMERICAN CONGRESS ON NATURAL AND APPLIED SCIENCES

Sarayı ise 1749 yılında Venier ailesi tarafından mimar Lorenzo Boschetti'ye yaptırılmıştır (Venice Museum, b.t.; Penny Guggenheim Collection, b.t.).

### 2.1.4. Abu Dhabi Guggenheim Müzesi (Abu Dhabi-BAE)

Frank Gehry tarafından tasarlanan ve Saadiyat Adası'nda yapım aşamasında olan müzede sergi alanını arttırmak için on bir adet ikonik koni kullanılmış; galeriler cam köprülerle birbirine bağlanmıştır. Eğitim merkezi ve tiyatroya sahip olan müze konferans, sempozyum, resital, tiyatro ve film gösterimi gibi programları içermektedir (Tecimer, 2021).

### 2.2. Louvre Müzesi

Louvre'un Paris, Lens ve Abu Dabi'de olmak üzere üç farklı kentte müzeleri ve Tahran'da anlaşma sağlanan sergisi bulunmaktadır (Şekil 3).



Şekil 3. Louvre Müzelerinin konumları

#### 2.2.1. Louvre Müzesi (Paris-Fransa)

Louvre Müzesi, Fransa'nın ulusal müzesi ve sanat galerisidir. Paris'te 12. yüzyıldan kalma Philip Augustus kalesi içerisinde yer almaktadır. Sarayın Versailles'e taşınması ile birlikte alanın müze olarak kullanımı 18. yüzyılda ortaya çıkmış, yapının eklentileri 19. yüzyılda yapılmıştır. Dünyanın en çok ziyaret edilen sanat müzelerinden biri olan yapı, eski müzeyi daha erişilebilir kılmak için 1980'lerde ve 90'larda büyük bir tadilattan geçirilmiş. Ofisler, mağazalar, sergi alanları, depolama alanları ve park alanları, oditoryum, kafeteryadan gibi donatıları içeren bir yeraltı kompleksi inşa edilmiştir (Britannica, 2023).

### **2.2.2. Lens Louvre Müzesi (Lens-Fransa)**

2012 yılında Fransa'nın kuzeyindeki Lens'te Louvre'un bir uydu müzesi olarak açıldı. Japon mimarlar Kazuyo Sejima ve Ryue Nishizawa tarafından tasarlanan müze, bölgenin ekonomisini canlandırmayı ve Paris bölgesindeki kalabalığı hafifletmeyi amaçlıyordu. Ayrıca alan eski bir madenin üzerinde olması nedeniyle seçilerek endüstriyel geçmişin korunmasını ve madencilik alanında bir mekânsal dönüşümü de sağlamak istiyordu. Müze, çelik ve cam malzeme kullanılan beş binadan oluşmaktadır (Britannica, 2023; ArchDaily, 2012).

### **2.2.3. Abu Dhabi Louvre Müzesi (BAE)**

Jean Nouvel'in tasarladığı Louvre Müzesi, Arap Dünyasının ilk evrensel müzesidir. Saadiyat Adasındaki kültür bölgesinde yer alan müze ikonik mimari yapısıyla Birleşik Arap Emirliklerinin başarısının güncünü simgeleyecek öğelerle tasarlanmıştır. Arap mimarisindeki kubbelerden ilham alınarak tasarlanan yaklaşık 7.500 ton ağırlığında gümüş renkli bir kubbe ile kapalıdır (Tecimer, 2021; Experience Abu Dhabi, b.t.; Hasan, 2017; ArchDaily, 2017).

### **2.2.4. Louvre Müzesi Tahran Sergisi (Tahran-İran)**

İran Milli Müzesi ve Louvre Müzesi arasında yapılan anlaşma çerçevesinde, Louvre Müzesi'ndeki bazı eserler Tahran'da sergilenmiştir. Louvre'un Irak ve Suriye'deki kültürel mirasın korunmasında yardımcı olacağı söylemi, Abu Dhabi'de uydu müze inşası ile birlikte sergi önem kazanmaktadır (Arkeolojik Haber, b.t.; Bursalı, 2016).

## **SONUÇ**

Kentler, küreselleşmenin baskın olduğu bu yeni rekabetçi ortamda kültürel niteliklerini ön plana çıkararak ve bunu ikonik mimari temsiller üzerinden kurgulayarak markalaşmaya çalışmaktadırlar. Müzeler önemli birer kültürel öge olmakla birlikte uzun yıllara dayanan itibarları, gelişme stratejisi kurgulayarak dönüşmek isteyen kentler için bu müzelerin birer uydusuna sahip olarak kullanmayı içermektedir. Özellikle iki önemli müzenin uydularının turizmde yarattığı etki ve sahip oldukları mimari niteliklerle ortaya koydukları farklı nitelikteki yapılarla çalışmalara konu olmaktadır. Bu çalışmada da hedeflenen kültürel odaklı gelişim ortamında uydu müzelerin marka ve bilinirlik üzerindeki etkisini iki önemli müze olan Guggenheim ve Louvre üzerinden anlatmaktır.

## **KAYNAKÇA**

Altınbaşak, İ. ve Yalçın, E. (2010). City image and museums: the case of İstanbul. *International Journal of Culture, Tourism and Hospitality Research*, 4(3), 241-251.

**4TH INTERNATIONAL LATIN AMERICAN  
CONGRESS ON NATURAL AND APPLIED SCIENCES**

- ArchDaily. (2012). *Louvre Lens / SANAA*. Erişim Adresi: <https://www.archdaily.com/312978/louvre-lens-sanaa>.
- ArchDaily. (2017). *Louvre Abu Dhabi / Ateliers Jean Nouvel*. Erişim Adresi: [https://www.archdaily.com/883157/louvre-abu-dhabi-atelier-jean-nouvel?ad\\_source=search&ad\\_medium=projects\\_tab](https://www.archdaily.com/883157/louvre-abu-dhabi-atelier-jean-nouvel?ad_source=search&ad_medium=projects_tab).
- Arkeolojik Haber. (b.t.). *Louvre Müzesi eserleri Tahran'da sergileniyor*. Erişim Adresi: <https://www.arkeolojikhaber.com/galeri-louvre-muzesi-eserleri-tahranda-sergileniyor-325/sayfa-1/>.
- Arkitektuel. (2023a). *Solomon R. Guggenheim Müzesi*. Erişim Adresi: <https://www.arkitektuel.com/solomon-r-guggenheim-muzesi/>.
- Arkitektuel. (2023b). *Guggenheim Bilbao Müzesi*. Erişim Adresi: <https://www.arkitektuel.com/guggenheim-bilbao-muzesi/>.
- Britannica. (2023). *Louvre*. Erişim Adresi: <https://www.britannica.com/topic/Louvre-Museum>.
- Bursalı, A. (2016). *Louvre Müzesi İran ile kültürel miras ve arkeoloji işbirliği yapacak*. Erişim Adresi: <https://arkeofili.com/louvre-muzesi-iran-ile-kulturel-miras-ve-arkeoloji-isbirligi-yapacak/>
- Can, E. (2015). Boş zaman, rekreasyon ve etkinlik turizmi ilişkisi. *İstanbul Journal of Social Sciences*, 10, 1-17.
- Castillo-Villar, F.R. (2016). Urban icons and city branding development. *Journal of Place Management and Development*, 9(3), 255-268.
- Çevik, N. (2021). Müze depolarındaki eserlerin değerlendirilmesinde çağdaş yaklaşımlar: Depo ve uydu müzeler üzerine. *Türk Arkeoloji ve Etnografya Dergisi*, 82, 181-192.
- Deffner, A.M. ve Labrianidis, L. (2005). Planning culture and time in a mega-event: Thessaloniki as the European city of culture in 1997. *International Planning Studies*, 10(3-4), 241-264.
- Dragolea, L.L. ve Cotîrlea, D.A. (2012). One step closer to city branding through culture: Consumer preferences for cultural tourism services in Alba Rulia - customization on National Museum of Unification. *Annales Universitatis Apulensis Series Oeconomica*, 14(2), 680-687.
- Erkal, N. (2007). Mimarlık Turizmi: Turizmin nesnesi olarak “mimarlık” gösteri olarak mimarlık: turizmin güncel mimarlığa etkileri üzerine. *Mimarlık*, 336.
- Experience Abu Dhabi. (b.t.). *Louvre Abu Dhabi*. Erişim Adresi: <https://visitabudhabi.ae/en/what-to-see/historical-and-cultural-attractions/louvre-abu-dhabi>.

**4TH INTERNATIONAL LATIN AMERICAN  
CONGRESS ON NATURAL AND APPLIED SCIENCES**

- Gökçe, B. (2014). Müzelerin yönetim anlayışında meydana gelen değişimler. *Atatürk Üniversitesi Sosyal Bilimler Enstitüsü Dergisi*, 18(2), 217-227.
- Gökçen Dünder, Ş. (2010). Unvan peşindeki kentler: “mega” projeler ve “mega etkinlikler” üzerinden bir bakış. *Mimarlık*, 353, 53-58.
- Günay, M.A. (2018). Zeugma Mozaik Müzesinin Gaziantep marka kent algısına etkisi. *Akademik Sosyal Araştırmalar Dergisi*, 6(82), 686-712.
- Hasan, Z.G. (2017). *Critical round-up: The Louvre Abu Dhabi by Jean Nouvel*. Erişim Adresi: <https://www.archdaily.com/883911/critical-round-up-the-louvre-abu-dhabi-by-jean-nouvel>.
- Hazime, H. (2011). From city branding to e-brands in developing countries: An approach to Qatar and Abu Dhabi. *African Journal of Business Management*, 5(12), 4731-4745.
- İnce Kompil, E. ve Kompil, M. (2012). EXPO’92 organizasyonunun Sevilla kentine kazandırdıkları. *Oda*, 4, 32-37.
- Karaca, S. (2012). Türkiye’deki büyük ölçekli spor organizasyonlarının kentin kültürel gelişimine etkileri: Trabzon ve Erzurum örnekleri. *Oda*, 4, 42-47.
- Kayın, E. (2003). Marjinal mekanın gerçekliği ve görüntüsü. *Ege Mimarlık*, 2003/1-45, 15-16.
- Muratovski, G. (2012). The role of architecture and integrated design in city branding. *Place Branding and Public Diplomacy*, 8(3), 195-207.
- Özrili, Y. (2020). Müzelerde markalaşma ve kurumsal kimlik. *Bitlis Eren Üniversitesi Sosyal Bilimler Dergisi*, 9(2), 204-216.
- Pascal International Exchange. (b.t.). *The concept of satellite museums in regional development*. Erişim Adresi: <https://pie.pascalobservatory.org/pascalnow/pascal-activities/news/concept-satellite-museums-regional-development>.
- Pasquinelli, C. (2017). The Cultural Branding Matrix: framing the relation between cultural institutions and city branding. A. Campelo (Ed.), *Handbook on place branding and marketing* içinde (41-55). Cheltenham: Edward Elgar Publishing.
- Peker, A.E. (2012). *Kentin markalaşma sürecinde çağdaş sanat müzelerinin rolü: Kent markalaşması ve küresel landmark* (Yüksek Lisans Tezi). İstanbul: İstanbul Teknik Üniversitesi.
- Penny Guggenheim Collection. (b.t.). *Palazzo Venier dei Leoni*. Erişim Adresi: <https://www.guggenheim-venice.it/en/the-museum/palazzo-venier-dei-leoni/>.
- Rehan, R.M. (2013). Urban branding as an effective sustainability tool in urban development. *HBRC Journal*, 10(2), 1-9.



**4TH INTERNATIONAL LATIN AMERICAN  
CONGRESS ON NATURAL AND APPLIED SCIENCES**

- Riza, M.; Doratli, N. ve Fasli, M. (2012). City Branding and Identity. *Procedia - Social and Behavioral Sciences*, 35, 293-300.
- Steyn, S.M. (2010). *A contemporary museum experience: The design of a new satellite museum for the Ditsong: National Museum of Cultural History in Pretoria* (Yüksek Lisans Tezi). Pretoria: University of Pretoria.
- Tecimer, E.B. (2021). *Frank Gehry imzalı Guggenheim Müzesi'nin yeni açılış tarihi: 2026*. Erişim Adresi: <https://www.arkitera.com/haber/frank-gehry-imzali-guggenheim-muzesinin-yeni-acilis-tarihi-2026/>.
- Tezcan, S. (2011). *Kentler arası rekabet, kentsel pazarlama ve markalaşmanın planlama açısından değerlendirilmesi İzmir örneği* (Yüksek Lisans Tezi). İzmir: Dokuz Eylül Üniversitesi.
- Timur, M.N.; Çevik, S. ve Kıyık Kıcı, G. (2014). Etkinlik turizmi: Kültür başkenti etkinliklerinin başarı unsurları üzerine bir değerlendirme. *Akademik Sosyal Araştırmalar Dergisi*, 2(2/1), 56-83.
- Timur, M.N.; Çevik, S. ve Kıyık Kıcı, G. (2016). Destinasyon marka stratejisi olarak mega etkinlikler: Eskişehir 2013 Türk dünyası kültür başkenti örneği. *Uluslararası Sosyal Araştırmalar Dergisi*, 9(46), 1030-1044.
- Trabskaia, I.; Shuliateva, I.; Abushena, R.; Gordin, V. ve Dedova, M. (2019). City branding and museum souvenirs: towards improving the St. Petersburg city brand: Do museums sell souvenirs or do souvenirs sell museums?. *Journal of Place Management and Development*, 12(4), 529-544.
- Uysal, Ü.E. (2014). Büyük etkinlikler: Kente ve kent mekânına etkileri. *İ.Ü. Siyasal Bilgiler Fakültesi Dergisi*, 51, 163-179.
- Venice Museum. (b.t.). *Guggenheim Museum*. Erişim Adresi: <https://www.venice-museum.com/guggenheim-museum.php>.
- Wang, H.; Xiaokaiti, M.; Zhou, Y.; Yang, Y.; Liu, Y. ve Zhao, R. (2012). Mega-events and city branding: A case study of Shanghai World Expo 2010. *Journal of US-China Public Administration*, 9(11), 1283-1293.
- Yea, L. ve Björnerb, E. (2018). Linking city branding to multi-level urban governance in Chinese megacities: A case study of Guangzhou. *Cities*, 80, 29-37.
- Yu, L.; Wang, C. ve Seo, J. (2012). Mega event and destination brand: 2010 Shanghai Expo. *International Journal of Event and Festival Management*, 3(1), 46-65.

**GEOMORPHOLOGIC ANALYSIS OF THE YENİŞEHİR (BURSA) BASIN**

Yenişehir (Bursa) Havzasının Jeomorfolojik Analizi

**K. Ömer TAŞ**

K.Ömer Jeoloji Yük. Müh: Sakarya Üniversitesi, Fen Bilimleri Enstitüsü., Sakarya. ORCID  
No: 000-0001-7844-6465

**Günay BEYHAN**

Günay BEYHAN: Sakarya Üniversitesi, Mühendislik Fakültesi, Jeofizik Müh.Böl.  
Sakarya. ORCID No: 0000-0003-1341-9049.

**H. Haluk SELİM**

<sup>3</sup>H.Haluk SELİM: Milli Savunma Üniversitesi, ATASAREN Enstitüsü, İstanbul ORCID No.  
0000-0001-8704-4935.

**ABSTRACT**

The study area is, Yenişehir Basin where is located in the Southern Marmara region. Yenişehir Basin locates on the Southern branch of the NAFZ. The basin occupies at the changeover point of two segments and its geometric shape is a good example of the pull-apart basin type that develops in such regions. In this study, it is aimed to determine the tectonic activity in this basin by geomorphological analysis. For this purpose, Asymmetry factor (AF), Transverse topographic symmetry factor (T) and Mountain front sinuosity index (Smf) in the basin were calculated. The asymmetry factor and the transverse topographic symmetry factor are controlled by the stream in the basin and these values clearly reveal the tilting in the east direction. The transverse topographic symmetry factor reaches high ranks along Göksu Stream that crosses over the area on the eastern border of the basin. Based on these values, it is possible to determine the tilting in the basin. In order to determine the faults that are effective in tilting, the Mountain front sinuosity index values, which give the fault activity, were also calculated. These values show that the faults are effective in forming the basin boundaries in the north and east tilting in accordance with the asymmetry factor and the transverse topographic symmetry factor.

**Keywords:** Morfometric indices, tilting, Southern branch of the NAFZ, Yenişehir

**ÖZET**

Çalışma alanı, Güney Marmara bölgesinde bulunan Yenişehir Havzasıdır. Yenişehir Havzası Kuzey Anadolu Fay Zonu (KAFZ)'nin Güney kolunda yer almaktadır. Havza iki segmentin geçiş noktasında yer alır ve geometrik şekli bu bölgelerde gelişen çek-ayır havza tipine iyi bir örnektir. Bu çalışmada, bu havzadaki tektonik aktivitenin jeomorfolojik analizlerle belirlenmesi amaçlanmaktadır. Bu amaçla havzadaki Asimetri faktörü (AF), Transvers topografik simetri faktörü (T) ve Dağ önü kıvrımlılık indeksi (Smf) hesaplanmıştır. Asimetri faktörü ve transvers topoğrafik simetri faktörü havzadaki akarsu tarafından kontrol

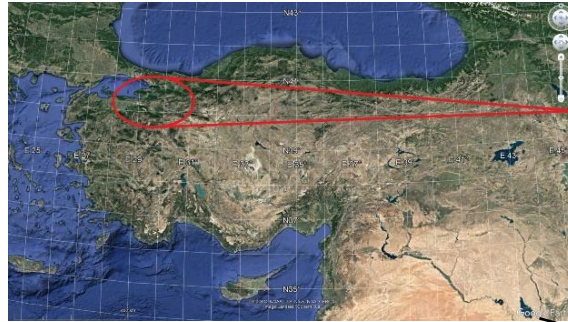
## 4TH INTERNATIONAL LATIN AMERICAN CONGRESS ON NATURAL AND APPLIED SCIENCES

edilmektedir ve bu deęerler doęu yönüne doęru gelişmiş bir devrilmeyi açıkça ortaya koymaktadır. Transvers topoęrafik simetri faktörü, havzanın doęu sınırındaki alandan geçen Göksu Çayı boyunca yüksek seviyelere ulaşmaktadır. Bu deęerlere göre havzadaki devrilmeyi saptamak mümkündür. Eğimde etkili olan fayları belirlemek için fay aktivitesini veren Daę önü kıvrımlılık indeksi deęerleri de hesaplanmıştır. Bu deęerler, asimetri faktörü ve transvers topoęrafik simetri faktörüne göre fayların, havzanın kuzey ve doęu yönünde devrilmesinde ve havza sınırlarının oluşturulmasında etkili olduğunu göstermektedir.

**Anahtar Kelimeler:** Morfometrik indeksler, devrilme, KAFZ'nin güney kolu, Yenişehir

### 1. INTRODUCTION

The study area is located on the southern branch of the NAFZ, which is one of the determining elements of Türkiye tectonics) (Fig.1). The NAFZ has the geometrical transform fault character and produces approximately 2,5 cm of slip per year (Reilinger et.al., 2006). NAFZ is divided into two branches in the Marmara region. Of these two branches, the South branch comprise of two parts as is less active and the slip rate is lower than the North branch. For this reason, the high-magnitude earthquake interval it produces is longer than the North branch. This character of the fault makes it even more important to clearly determine its activity (Selim, 2005).



**4TH INTERNATIONAL LATIN AMERICAN  
CONGRESS ON NATURAL AND APPLIED SCIENCES**



Figure 1. Location of study area. (Google Earth, 2023)

Along the NAFZ on the Anatolian Plate, the various morphologic features and traces are observed in different types on the segments. These are clearly observed structures such as hot or cold water springs, offsets on the streams, elongated ridges, witness crests, and the development of push-up ridges and pull-apart basins. The existence of these structures is supported by various morphologic calculation methods. In cases where erosional effects are fast but the fault velocity is slow, these effects are difficult to see. For this reason, it is important to use geomorphological data to understand the tectonic structure of the study area and to define active faults.

The geological examination of the study area, Cenozoic aged units are observed unconformably overlying the older units. These Cenozoic units are also unconformably covered by Quaternary units (Fig.2).



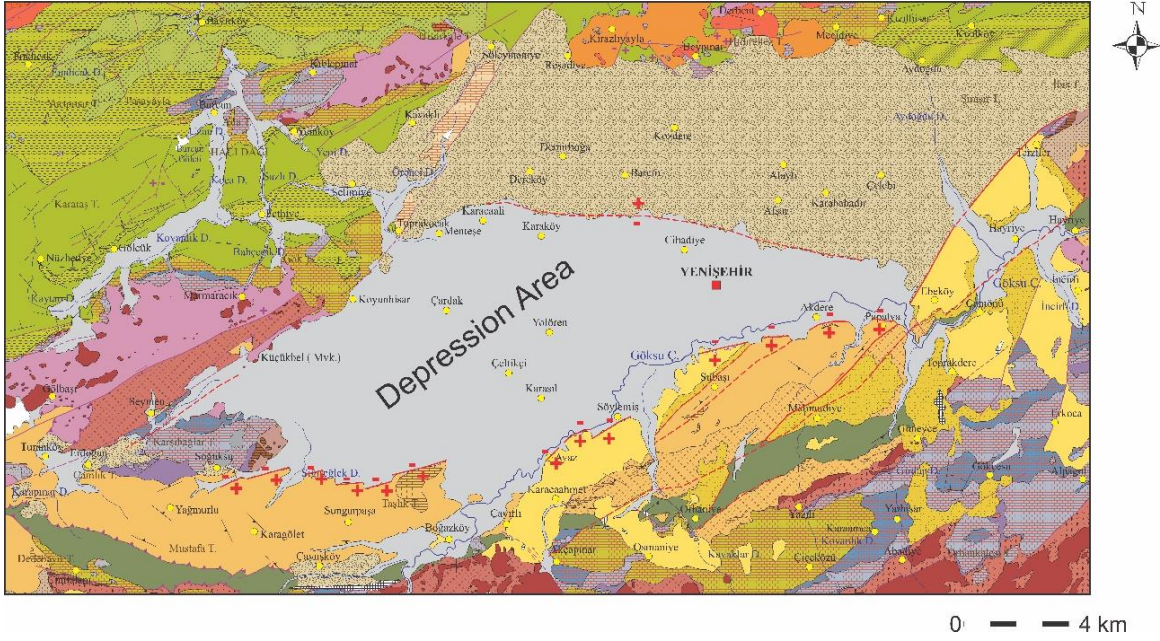


Figure 2. Geology of study area

It is compatible with fault settlements in seismic data. Although there are earthquake epicenter points in the entire basin, the points where they mainly gather are the basin boundaries (Fig. 3).

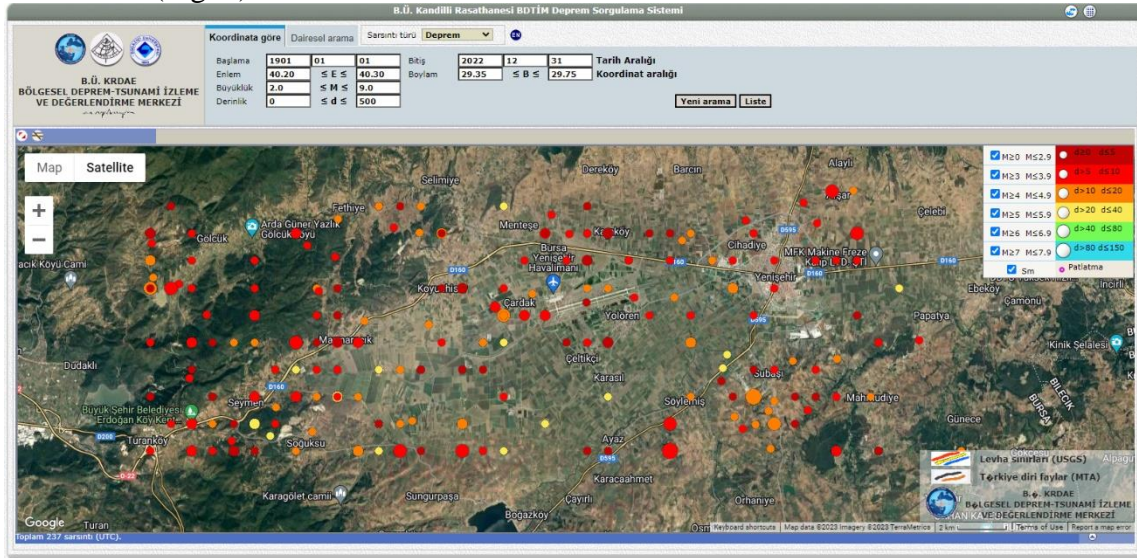


Figure 3. Seismicity of area for 120 years between 01-01-1901 an 31-12-2020. (KOERI, 2023).

## 2. GEOMORPHIC SETTINGS

When the Yenisehir basin is examined in terms of geology and tectonics, it has a pull-apart basin geometry that can be called almost ideal. This means that the formation of the basin is completely fault-controlled. In order to understand the fault character of the basin, the activity of the faults forming this structure can be understood by morphological methods. For this purpose, three different geomorphic indices were used such as asymmetry factor, transverse topographic symmetry factor and front-mountain sinosity.

### 2.1. Asymmetry Factor (AF)

Being searched basin tilting, the asymmetry factor is first calculated according by formula 1. In this way, it is determined whether the stream in the basin is affected by tectonism (Fig. 4).

$$A_F = 100. \left( \frac{A_R}{A_T} \right) \quad (1)$$

$A_T$  (The entire area)

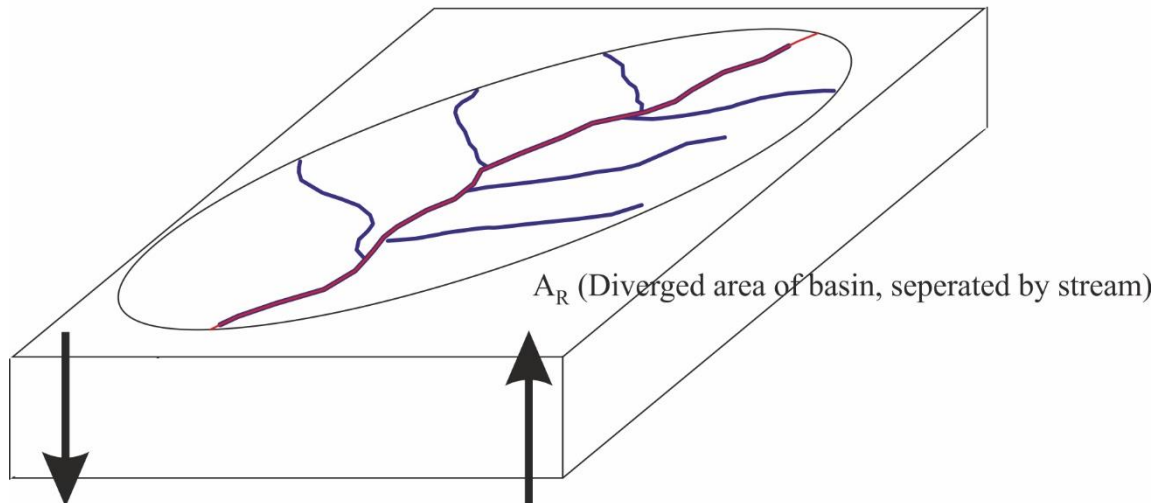


Figure 4. Application of Asymmetry Factor (Keller and Pinter 2002).

The basin which has no tilting, this value should be 50 and around, regardless of the stream's edge (Keller and Pinter 2002). A low value indicates the falling side. In the Yenişehir basin, the values were found to be 10.73 in the eastern part and 89.27 in the western part. This value shows that the stream flows along the eastern shore and the Yenişehir basin is tilted to the east clearly.

### 2.2. Transvers Topoğrafik Simetri Faktörü (T)

The transverse topographic symmetry factor of the basin is also used in the calculations related to tilting. This index is presented according to the location of the stream in the basin and the basin axis and varies between 0 and 1 (Formula number 2). While this value is 0 in the basin without tilting, it increases with tilting. (Keller and Pinter 2002).

$$T = \frac{D_n}{D_t} \quad (2)$$

Since the transverse topographic symmetry factor values has been taken along the fault on the east border of the basin, the parts where the fault is effective on the topography are obtained graphically (Fig. 5).



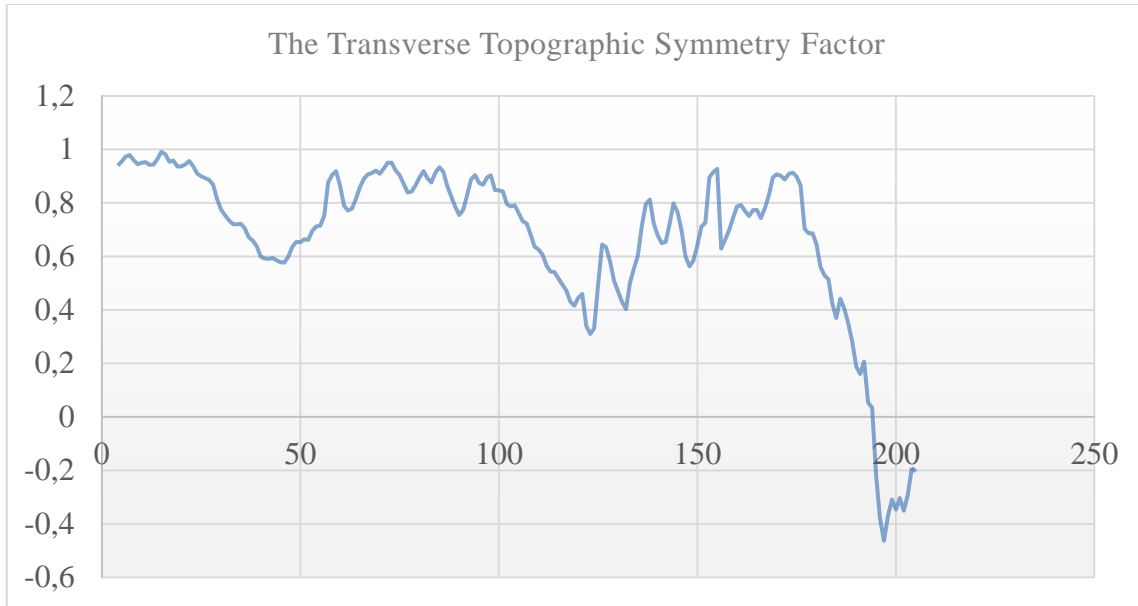


Figure 5. The graph of change in the transverse topographic symmetry factor (T) value between Boğazköy and Ebeköy of the Göksu Stream passing the Yenişehir basin.

Transverse topographic symmetry factor values show that the basin is tilted in the east direction and this tilting is fault originated.

### 2.3. Mountain-Front Sinuosity (Smf)

The effect of the fault on the morphology may increase or decrease depending on the erosion. Therefore, the determination of the erosion rate is necessary for the health of the results obtained. In order to determine the level of the erosional effect, the mountain-front sinuosity values are decisive.

The speed of the fault, which determines the morphology, is important for the accuracy of the geomorphological analysis. Because a relatively inactive fault that develops in the region with high erosional effect may not be detected. Therefore, determining of the erosional activity in the land is very important. The mountain-front sinuosity is an analysis that gives the speed of erosional activity in the region (Fig. 6).

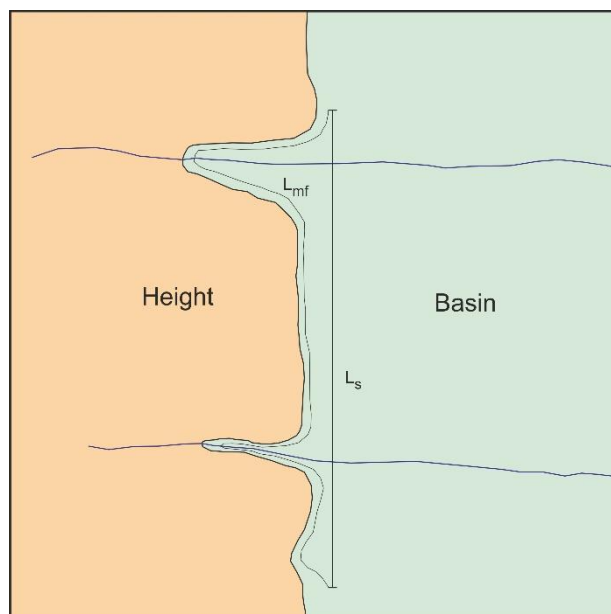


Figure 6. Usage of Mountain-Front Sinuosity.

Yenişehir basin is a fault-controlled basin. The mountain-front sinuosity at the borders of the basin were calculated according to the formula number 3. A low value indicates a tectonic controlled surface, while a high value indicates an erosional controlled surface. (Keller & Pinter, 2002).

$$S_{mf} = \frac{L_{mf}}{L_s} \quad (3)$$

The Yenişehir basin is in the pull-apart style of the basin. For this reason, this value has been calculated in all basin borders. A value of 1.88 indicating moderate tectonic control was obtained at the northeastern border, and 1.58 indicating active tectonic activity at the eastern border. The value on the southern border is 13.11, which indicates a completely inactive border. Low tectonic activity ( $S_{mf} = 4.48$ ) is observed on the western border. This value decreases as you move north. On the northern border, values of 1.52-1.62 are seen. Accordingly, the northern and eastern slopes of the basin are under active fault control.

### 3. RESULTS and DISCUSSION

The Yenişehir basin clearly has tectonic origin. This study aimed to define characterization and tilting of this basin and pass over morphometric indices.

The study area generally are formed by older units than Eocene aged units and these units are covered by younger units. These units are generally weak and eroded easily. For this purpose, morphometric indices are determinant to define this fault.

In this study, to define tectonic character of Yenişehir basin located south of İznik Lake via geomorphologic indices. For this purpose three different morphometric indices has been calculated about the basin and stream.

1. Asymmetry Factor ( $A_F$ )
2. Transverse Topographic Symmetry Factor (T)
3. Mountain-Front Sinuosity ( $S_{mf}$ )

## 4TH INTERNATIONAL LATIN AMERICAN CONGRESS ON NATURAL AND APPLIED SCIENCES

Tilting in the basin was determined by Asymmetry Factor index analysis, tilting degree was determined by Transverse Topographic Symmetry Factor index analysis, and tectonic activity levels on faults forming the basin were determined with Mountain-Front Sinuosity. For as a result, Yenişehir basin are formed Southern Branch of NAFZ and this fault has still been active.

### 4. REFERENCES

- Earth Engine Data Catalog, 2023. A planetary-scale platform for Earth science data & analysis, Nasa SRTM verisi. <https://developers.google.com/earth-engine/datasets>
- Keller E.A. and Pinter, N., 2002. Active Tectonics, Earthquakes, uplift and landscape. Prentice-Hall, New Jersey, 338 pages.
- Reilinger, R., McClusky, S., Vernant, P., Lawrence, S., Ergintav, S., Çakmak, R., Özener, H., Kadirov, F., Guliev, İ., Stepanyan, R., Nadariya, M., Hahubia, G., Mahmoud, S., Sakr, K., ArRajehi, A., Paradissis, D., AlAydrus, A., Prilepin, M., Guseva, T., Evren, E., Dmitrova, A., Filikov, S.V., Gomez, F., Al-Ghazzi, R., Karam, G., 2006. GPS constraints on continental deformation in the Africa-Arabia-Eurasia continental collision zone and implications for the dynamics of plate interactions, *J. Geophys. Res.*, 111, B05411, doi:10.1029/2005JB004051.
- Selim, H.H. 2005. Kuzey Anadolu Fayı'nın Güney Koluna ait Yenice-Gönen, Manyas-Mustafakemalpaşa, Uluabat ve Bursa faylarının morfolojik, sismolojik ve jeolojik özellikleri, Doktora Tezi, 232 sf, İstanbul.
- Google Maps, 2023. Google Inc. Harita verisi. [www.google.com](http://www.google.com).
- K.R.D.A.M., 2023. Boğaziçi Üniversitesi, Kandilli Rasathanesi, Deprem Araştırma Merkezi verisi, [www.koeri.boun.edu.tr](http://www.koeri.boun.edu.tr), İstanbul

**FOOD WASTE AND FOOD LOSS: CAUSES, EFFECTS AND SOLUTIONS**

**GIDA ATIĞI VE GIDA KAYBI: NEDENLERİ, ETKİLERİ VE ÇÖZÜMLERİ**

**Oktay TOMAR**

Doç. Dr., Kocaeli Üniversitesi

ORCID NO: 0000-0001-5761-7157

**Alptekin Mert YILMAZ**

Arş. Gör., Kocaeli Üniversitesi

ORCID NO: 0000-0002-7062-4770

**ÖZET**

Gıda atığı ve gıda kaybı, acil müdahale gerektiren kritik küresel sorunlardır. Birleşmiş Milletler Gıda ve Tarım Örgütü'ne göre, her yıl dünyada üretilen tüm gıdaların yaklaşık üçte biri kayboluyor veya atık oluyor. Bu, kabaca 1 trilyon dolar değerinde yaklaşık 1,3 milyar ton gıda anlamına gelmektedir. Bu çalışmada, gıda kaybının ve gıda atıklarının nedenleri ve etkileri incelenmekte ve bu küresel soruna olası çözümler araştırılmaktadır. Gıda kaybı, öncelikle gıda tedarik zincirinin üretim ve dağıtım aşamalarında meydana gelirken, gıda atığı ise tüketim aşamasında meydana gelmektedir. Gelişmekte olan ülkelerde, gıda kaybı genellikle yetersiz altyapı, uygun depolama tesislerinin olmaması ve zayıf ulaşım sistemlerinden kaynaklanmaktadır. Bunun aksine, gelişmiş ülkelerdeki gıda atığı, aşırı satın alma, bozulmuş gıdaları atma ve kozmetik kusurlar nedeniyle yenilebilir gıdaları atma gibi tüketici davranışlarından kaynaklanmaktadır. Gıda atığının ve gıda kaybının çevresel ve sosyal etkileri önemlidir. Su, toprak ve enerji gibi kaynakların israfına ek olarak, gıda atığı da sera gazı emisyonlarına katkıda bulunmaktadır. Yiyecekler çöplüklerde ayrıştığında, 100 yıllık bir süre boyunca karbondioksitten 28 kat daha etkili olan güçlü bir sera gazı olan metan salmaktadır. Dahası, gıda atığı, özellikle milyonlarca insanın açlık ve yetersiz beslenmeden muzdarip olduğu gelişmekte olan ülkelerde gıda güvencesizliğini ve açlığı şiddetlendirmektedir. Bu sorunları ele almak için, hem küresel hem de yerel düzeylerde bir dizi önlem önerilmiştir. Birleşmiş Milletler, küresel düzeyde, 2030 yılına kadar gıda atığı ve gıda kaybını %50 oranında azaltmak için bir hedef belirlemiştir. Bu hedef, herkes için sürdürülebilir bir gelecek yaratma planı olan Sürdürülebilir Kalkınma Hedeflerinin bir parçasıdır. Sürdürülebilir Kalkınma Hedefleri, yoksulluk, açlık ve iklim değişikliği gibi küresel sorunların ele alınması için bir çerçeve sağlamaktadır. Yerel düzeyde, gıda atığını ve gıda kaybını azaltmak için çeşitli müdahaleler uygulanmaktadır. Örneğin, birçok ülkede gıda atığı konusunda farkındalık yaratmaya yönelik kampanyalar başlatıldı ve tüketicileri yalnızca ihtiyaç duyduklarını satın almak ve artıkları kullanmak gibi davranışlarında değişiklik yapmaya teşvik edilmiştir. Bu arada, yenilebilir gıdaları atılmaktan kurtarmak ve ihtiyacı olanlara yeniden dağıtmak için gıda geri kazanım programları oluşturulmuştur. Bu yaklaşım

## 4TH INTERNATIONAL LATIN AMERICAN CONGRESS ON NATURAL AND APPLIED SCIENCES

yalnızca gıda atığını azaltmakla kalmaz, aynı zamanda gıda güvencesizliğinin giderilmesine de yardımcı olmaktadır. Diğer bir yaklaşım ise, tarımsal uygulamaları ve hasat sonrası işlemeyi iyileştirerek gıda kaybını azaltmaktır. Örneğin, soğutma, depolama ve taşıma sistemleri gibi altyapıya yatırım yapmak, dağıtım aşamasında gıda kaybını azaltabilmektedir. Ek olarak, mahsul çeşitlendirmesi ve kuraklığa dayanıklı mahsullerin kullanılması, mahsul verimini artırabilir ve mahsul yetersizliğinden kaynaklanan gıda kaybını azaltabilmektedir. Sonuç olarak, gıda atığı ve gıda kaybı, her düzeyde eylem gerektiren başlıca küresel sorunlardır. Sorun karmaşık ve çok yönlü olsa da, gıda atığını ve gıda kaybını azaltmak için tarımsal uygulamaların iyileştirilmesinden tüketici davranışının değiştirilmesine kadar bir dizi müdahale uygulanabilir. Birlikte çalışarak herkes için daha sürdürülebilir ve eşitlikçi bir gıda sistemi oluşturabiliriz.

**Anahtar Kelimeler:** Gıda Atığı, Gıda Kaybı, Gıda Güvencesi, Sürdürülebilir Kalkınma.

### ABSTRACT

Food waste and food loss are critical global issues that require urgent attention. According to the United Nations Food and Agriculture Organization, approximately one-third of all food produced in the world is lost or wasted every year. This translates to around 1.3 billion tons of food, worth roughly \$1 trillion. In this paper, we examine the causes and effects of food loss and food waste, and explore potential solutions to this global problem. Food loss occurs primarily during the production and distribution stages of the food supply chain, while food waste occurs at the consumption stage. In developing countries, food loss is usually due to inadequate infrastructure, lack of proper storage facilities, and poor transportation systems. In contrast, food waste in developed countries is mainly attributed to consumers' behavior, such as over-purchasing, discarding of spoiled food, and throwing away edible food due to cosmetic imperfections. The environmental and social impacts of food waste and food loss are significant. In addition to wasting resources such as water, land, and energy, food waste also contributes to greenhouse gas emissions. When food decomposes in landfills, it releases methane, a potent greenhouse gas that is 28 times more potent than carbon dioxide over a 100-year period. Moreover, food waste exacerbates food insecurity and hunger, particularly in developing countries, where millions of people suffer from hunger and malnutrition. To address these issues, a range of measures has been proposed at both the global and local levels. At the global level, the United Nations has set a goal to reduce food waste and food loss by 50% by 2030. This goal is part of the Sustainable Development Goals, a blueprint for creating a sustainable future for all. The SDGs provide a framework for addressing global challenges such as poverty, hunger, and climate change. At the local level, a variety of interventions has been implemented to reduce food waste and food loss. For example, campaigns to raise awareness about the issue of food waste have been launched in several countries, encouraging consumers to make changes to their behavior such as buying only what they need and using leftovers. Meanwhile, food recovery programs have been established to rescue edible food from being thrown away and redistribute it to those in need. This approach not only reduces food waste but also helps address food insecurity. Another

approach is to reduce food loss by improving agricultural practices and post-harvest handling. For instance, investing in infrastructure such as refrigeration, storage, and transportation systems can reduce food loss during the distribution phase. Additionally, crop diversification and the use of drought-resistant crops can increase crop yields and reduce food loss due to crop failure. In conclusion, food waste and food loss are major global issues that require action at all levels. While the problem is complex and multifaceted, a range of interventions can be implemented to reduce food waste and food loss, from improving agricultural practices to changing consumer behavior. By working together, we can create a more sustainable and equitable food system for all.

**Keywords:** Food Waste, Food Loss, Food Security, Sustainable Development.

## 1. Giriş

Küresel çapta gıda atığı ve gıda kaybı miktarı giderek artış göstermektedir (Thyberg ve ark., 2015). Aynı zamanda gıda kaybı ve gıda atığına yönelik küresel ilgi de son yıllarda artmaktadır (Papargyropoulou ve ark., 2014; FAO, 2019a). İnsan tüketimine yönelik gıdaların yaklaşık üçte biri gıda tedarik zincirlerinde israf edildiğinden dolayı gıda kaybı ve gıda atıkları küresel çapta bir sorun oluşturmaktadır (Gustavsson ve ark., 2011). Bu miktarın yetersiz beslenen 870 milyon insanı besleyebileceği belirtilmektedir (FAO, 2019b). Küresel gıda atık ve kayıplarının toplam ekonomik değerinin 1 trilyon dolar olduğu tahmin edilmektedir. Sosyal ve ekonomik maliyetler dikkate alındığında bu değer 2,6 trilyon dolara yükselmektedir (FAO, 2014). Türkiye’de yıllık olarak yaklaşık 26 milyon ton yenilebilir gıda atığı ve kaybı olduğu tespit edilmiştir (Salihoğlu ve ark., 2018). Bunun artan sera gazı emisyonları, kaynakların tükenmesi ve gıda güvencesizliği dahil olmak üzere önemli ekonomik, çevresel ve sosyal sonuçları bulunmaktadır. Atık gıdalar, küresel gıda sisteminin önemli sorunlarından birisidir. Ayrıca gıda atıkları kaynaklı olarak tedarik zincirindeki sera gazı (GHG) emisyonları hesaba katıldığında küresel emisyonların %6,8’ini gıda atık ve kayıpları oluşturmaktadır (FAO, 2015; The World Bank, 2016).

Döngüsel ekonomi kavramının son yıllarda önem kazanmasıyla gıda atığı konusu Avrupa Birliği’nde de (AB) önem kazanmaya başlamıştır (EC, 2015). Bu aynı zamanda Birleşmiş Milletler Sürdürülebilir Kalkınma Hedeflerine (SDG’ler) de yansıtılmaktadır. Bu hedeflerde, perakende ve tüketici seviyelerinde küresel kişi başına gıda israfının %50 azaltılması ve 2030 yılına kadar üretim ve tedarik zincirleri boyunca gıda kaybının azaltılması çağrısı yer almaktadır (UN, 2015; FAO, 2020). Uygun atık yönetimi, sürdürülebilir kalkınma için temel bir ön koşul olarak kabul edilmektedir (UNHSP, 2010; UNEP, 2011).

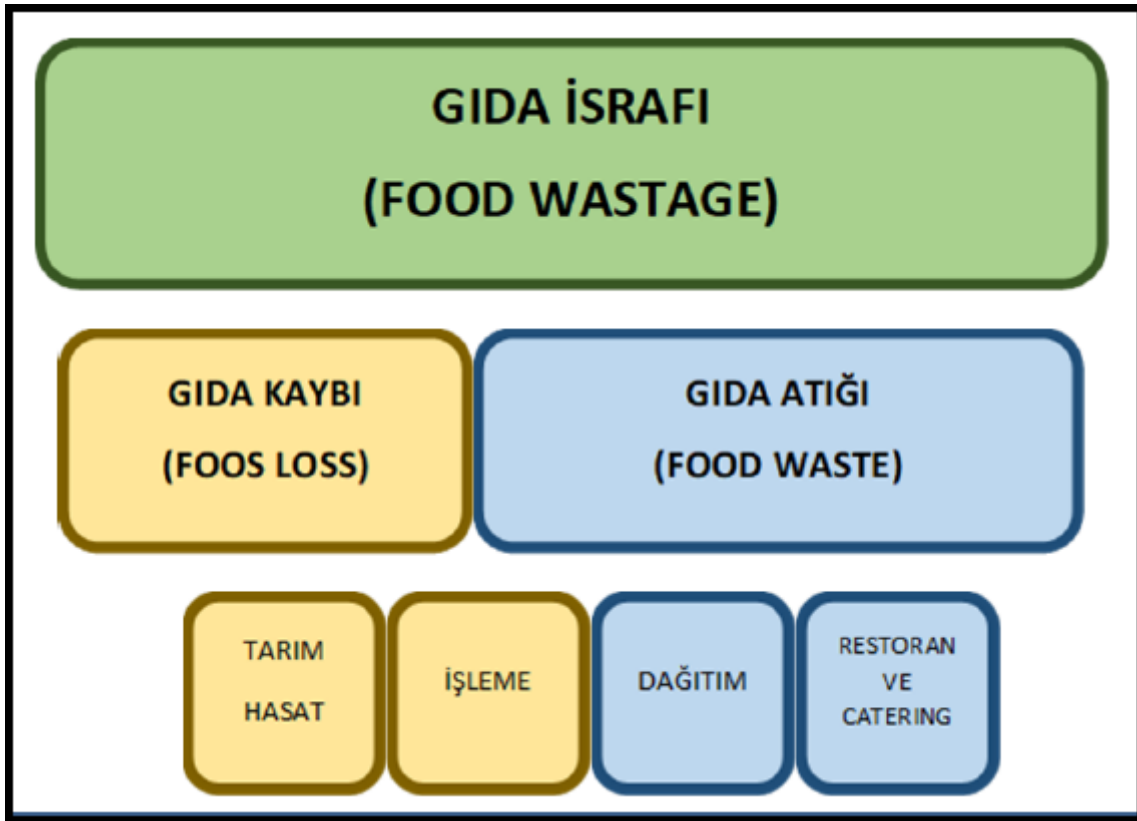
Küresel nüfus artışı, kentleşme ve gelir artışı gibi faktörler beslenme kalıplarının değişmesine, et ve süt ürünleri, toprak ve su başta olmak üzere doğal kaynaklara olan talebin artmasına yol açmaktadır. Tüm bunların sera gazı artışlarıyla doğrudan bağlantısı bulunmaktadır. Küresel nüfus ve tüketim artışının 2050 yılına kadar küresel gıda talebinde artış yaratacağı ve bu durumun doğal kaynaklarda yoğun baskı yaratacağı tahmin edilmektedir (Godfray ve ark., 2010). Bu zorluklar, çevresel koşulların da değişiklik göstermesiyle birlikte gıda üretiminin giderek zorlaşmasına ve öngörülemez bir hale gelmesine yol açmaktadır (Garnett, 2014). Artan dünya nüfusunu sürdürülebilir bir şekilde beslemek amacıyla yeterli gıdanın mevcut olmasını sağlamada gıda sistemlerinin birçok olumsuz çevresel etkisinin en aza indirilmesi gerekmektedir (Tilman ve ark., 2001). Daha sürdürülebilir gıda sistemlerine geçiş, gıda atıklarının azaltılması ve gıda üretiminin artırılması elzemdir (Godfray ve Garnett,



2014). Yenilebilir gıdaları israf ederek, o gıdayı yetiştirmek, üretmek, işlemek ve taşımak için harcanan tüm kaynaklar da israf edilmiş olur. (Gustavsson ve ark., 2011). Gıda atıklarının ve kayıplarının önlenmesi ve geri kazanılması ile ilgili son yıllarda artan bir ilgi söz konusudur. Ancak, mevcut olarak çok az gıda atığı geri kazanılmaktadır (USEPA, 2014). Gıda israfının azaltılması ve uygun atık yönetimi aynı zamanda ekonomik kaynakları koruyabilir, gıda güvenesi katkıda bulunabilir (Thyberg ve Tonjes, 2016). Gıda atık ve kayıplarının azaltılmasının gıda güvenesine olan katkısı açıktır. Bu çalışmada gıda atıkları ve kaybının nedenleri ve etkilerinin yanı sıra bu sorunu ele almak için mevcut ve olası çözümler değerlendirilmektedir.

## 2. Gıda İsrافی, Gıda Atığı ve Gıda Kaybı Kavramları

Küresel olarak ortak bir tanımın belirlenmemiş olması (Lebersorger ve Schneider, 2011) bu konuların incelenmesini ve miktarının belirlenmesini zorlaştırmaktadır (Buzby ve Hyman, 2012). Gıda kaybı, gıda atığı, gıda israfı, biyolojik atık ve mutfak atığı gibi birçok terim birbirinin yerine kullanılmaktadır (Schneider, 2013). Ayrıca sıklıkla aynı terimler farklı anlamlarda kullanılmaktadır (Gjerris ve Gaiani, 2013).



Şekil 1. Gıda İsrافی, Gıda Atığı ve Gıda Kaybı (FoodDrinksEuropa, 2020’den aktaran Tahmaz ve Aksoy, 2022).

Şekil 1’de görüleceği üzere gıda israfı gıda tedarik zincirinin tamamında yaşanmaktadır. Gıda kaybı tarım, hasat ve işleme olmak üzere gıda tedarik zincirinin ilk üç aşamasında; gıda atığı ise dağıtım ve tüketim aşamaları olmak üzere gıda tedarik zincirinin son iki aşamasında oluşmaktadır (Tahmaz ve Aksoy, 2022). Gıda israfı, “başlangıçta insan tüketimi için olan yenilebilir gıda miktarındaki azalma” şeklinde açıklanmakta ve gıda tedarik zincirinin tamamında yaşandığından dolayı gıda tedarik zincirinin her aşamasındaki azalma olarak ifade edilmektedir (FoodDrinkEuropa, 2020). Gıda atığı “perakendeciler, gıda hizmeti verenler ve tüketiciler tarafından alınan kararlar ve eylemler sonucunda gıda miktarında veya

kalitesinde meydana gelen azalma” şeklinde tanımlanmaktadır (FAO, 2019c). Gıda kaybı, “perakendeciler, gıda hizmeti sağlayıcıları ve tüketiciler hariç, zincirdeki gıda tedarikçilerinin karar ve eylemlerinden kaynaklanan gıda miktarında veya kalitesinde meydana gelen azalma” şeklinde açıklanmaktadır (FAO, 2022). Buna göre üretim, taşıma ve depolama, işleme ve paketleme, dağıtım ve pazarlama, tüketim olmak üzere 5 aşamaya ayrılabilen gıda tedarik zincirinde ilk üç aşamada gıda kaybı ve son iki aşamada gıda atığı meydana geldiği söylenebilmektedir (Tahmaz ve Aksoy, 2022).

### **3. Gıda Atığı ve Kaybının Nedenleri**

Gıda atığı ve kaybı, üretim, işleme, dağıtım ve tüketim dahil olmak üzere gıda tedarik zincirinin çeşitli aşamalarında meydana gelebilmektedir. Gelişmekte olan ülkelerde, yetersiz depolama tesisleri ve ulaşım sistemleri de dahil olmak üzere yetersiz altyapı nedeniyle gıda kaybı daha yaygındır. Buna karşılık, gıda atığı, atığın büyük bir kısmından tüketicilerin ve perakendecilerin sorumlu olduğu gelişmiş ülkelerde daha yaygındır. Gıda atığı ve kaybının nedenleri arasında aşırı üretim, kötü depolama ve taşıma, kozmetik standartlar ve tüketici davranışları sayılabilmektedir. Gelişmiş ülkelerde, gıda atığı ve kaybının çoğu tüketici düzeyinde meydana gelmektedir.

#### **3.1. Tarımsal Üretim Aşaması**

Tarımsal üretim aşamasında oluşan gıda atık ve kaybı küresel olarak 412,9 milyon tondur (Gustavsson ve ark., 2013). Türkiye ise bu miktarın %3,33'ünü oluşturmaktadır (Salihoğlu ve ark., 2018). Tarımsal üretim aşamasındaki oluşan gıda kayıplarının nedenleri arasında gübre ve zirai ilaçların neden olduğu zararlar, hasat zararları (yumru kesimleri, erken sökmeye vb.), yanlış meyve toplama yöntemleri ve kötü ahır koşulları yer almaktadır (Tatlıdil ve ark., 2013).

#### **3.2. Hasat Sonrası Taşıma ve Depolama Aşaması**

Küresel çapta oluşan gıda atığı ve kaybının %24'ü hasat sonrası taşıma ve depolama işlemleri sırasında oluşmaktadır (Gustavsson ve ark., 2011; Lipinski ve ark., 2013). Hasat sonrası taşıma ve depolama aşamasındaki oluşan gıda kayıp ve atıklarının nedenleri arasında depolama koşullarının yetersizliği ve uygun olmaması ve sıcaklık yönetimindeki problemler temel faktörler arasındadır. Ayrıca tırların nakliye sırasında yanlış kaplanması, uygun olmayan depolama koşulları, nakliyede gecikmeler ve düşük kaliteli paketleme bu aşamadaki birçok kayıp nedeni arasındadır (HLPE, 2014; Salihoğlu ve ark., 2018). Hasat sonrası taşıma ve depolamadan kaynaklanan dünya gıda kaybı 293,40 milyon tondur ve Türkiye'nin kaybı dünyadaki kaybın yaklaşık %1,48'idir (Salihoğlu ve ark., 2018).

#### **3.3. İşleme, Paketleme ve Dağıtım Aşamaları**

Gıda tedarik zincirlerindeki işleme ve paketleme aşamasında dökülen süt, zarar görmüş balık, işlemeye uygun olmayan meyve ve sebzelerden dolayı gıda atığı ve kaybı oluşabilmektedir (Lipinski ve ark., 2013). İşleme hataları sonucunda nihai üründe yanlış boyut, ağırlık, şekil veya görünüm ve hasarlı ambalaj gibi kusurlar oluşabilmektedir (HLPE, 2014). Türkiye'de işleme ve paketleme aşamasında oluşan toplam gıda atığı ve kaybı yaklaşık 3,44 milyon ton olarak tespit edilmiştir (Salihoğlu ve ark., 2018). İşleme ve paketlemeden kaynaklanan küresel gıda atığı ve kaybı 147,50 milyon ton olup Türkiye'nin kaybı, küresel kaybın yaklaşık %3,44'üdür (Salihoğlu ve ark., 2018). Dağıtım basamağında oluşan küresel

gıda kaybı ve atığı 160,60 milyon tondur (Gustavsson ve ark., 2013) ve Türkiye'nin kaybı dünyadaki kaybın yaklaşık %2,25'idir (Salihoğlu ve ark., 2018). Soğuk zincir kurallarına uyulmaması, yetersiz havalandırma ve düşük kaliteli paketleme bu aşamadaki kayıpların nedenleri arasındadır (Salihoğlu ve ark., 2018).

### **3.4. Tüketim Aşaması**

Salihoğlu ve ark. (2018) tarafından yapılan çalışmada Türkiye'de gıda atık ve kayıplarının %8'inin tüketim aşamasında meydana geldiği belirtilmektedir. Hanehalkı tarafından yapılan gıda atık ve kaybının nedenleri arasında dökülmeler, yetersiz depolama, tahılların ve yumruların filizlenmesi, tüketicilerin etiketleme konusunda yaşadığı kafa karışıklığı, gıda hazırlama, tutum ve tercihler hakkında bilgi eksikliği, sosyo-demografik faktörler ve mevsimsel faktörler yer almaktadır (Buzby ve Hyman, 2012). Yapılan bir çalışmada Türkiye'de gıda atık ve kaybının en büyük nedeninin son kullanma tarihinin geçmesi olduğu tespit edilmiştir (COMCEC, 2017). Ayrıca Avrupa Birliği'ndeki toplam gıda atığı ve kaybının %12'sinin yemek hizmeti sektöründen kaynaklandığı tahmin edilmektedir (FUSIONS, 2016). Gıda hizmeti sektöründen kaynaklanan gıda kaybı ve atığının nedenleri arasında, fazla hazırlanan gıda (müşteri sayısından emin olunmaması), son kullanma tarihinin gelmesi, müşterilerin çok fazla sipariş vermesi ve müşterilerin artıkları paket olarak eve götürmemesi sayılabilmektedir (COMCEC, 2017). Türkiye'de her yıl 542 bin ton buğdaya eşdeğer 2,1 milyar adet ekmeğin israf edildiği belirtilmektedir (Tarım ve Orman Bakanlığı, 2015).

### **4. Gıda Atığı ve Kaybının Etkileri**

Gıda atık ve kaybı, önemli ekonomik, çevresel ve sosyal etkiler yaratmaktadır (FAO, 2019a; Morone ve ark., 2019). Gıda atık veya kayıp olduğunda gıdayı üretmek, işlemek ve taşımak için kullanılan kaynaklar da israf edilerek sera gazı emisyonlarına ve kaynakların tükenmesine neden olmaktadır. Gıda güvencesi giderek daha önemli hale gelen küresel bir sorundur (UNEP, 2009; FAO, 1981) ve küresel gıda tedarik zincirlerinde israf edilen gıda miktarı bu sorunu daha da gün yüzüne çıkarmaktadır (Stuart, 2009). Gıda atığı ve gıda kaybı gıdanın mevcudiyetini azaltarak gıda güvencesizliğini şiddetlendirmektedir. Gelişmiş ülkelerde, atık ve kayıp gıdanın maliyeti tüketicilere ve işletmelere yansıtıldığından, gıda israfının ekonomik sonuçları da bulunmaktadır. Sürdürülebilir kaynak yönetimi, atığın bir kaynak olabileceği fikrine dayanmaktadır (Bringezu ve Bleischwitz, 2009). Kaynak kullanımını daha sürdürülebilir seviyelerle sınırlamak ve kaynak verimliliği uygulamak, iklim değişikliğine bağlı Sera Gazı (GHG) emisyonlarını etkili bir şekilde azaltabilir ve ayrıca ekonomik ve sosyal nitelikte başka faydalar sağlayabilir (Barrett ve Scott, 2012; Defra, 2011). Gıda atıkları ile ilişkili olarak, gıda zinciri boyunca kullanılan ambalaj ve tüketilemeyen malzemeler çevre üzerinde baskı oluşturmakta ve tüketiciler ve üreticiler için bir yük oluşturmaktadır (Ferreira da Cruz ve ark., 2012; Williams ve ark., 2012). Aşırı gıda üretimi, toprak, su ve fosil yakıtlar dahil olmak üzere doğal kaynakların aşırı kullanımına yol açmaktadır (Pinstrop-Andersen, 1999; McLaughlin ve Kinzelbach, 2015). Bu da gereksiz kaynak tüketimine neden olmaktadır. Ayrıca, depolama alanlarındaki gıdaların bozulması metan ve karbondioksit salarak sera gazı emisyonlarını artırmaktadır (Hall ve ark., 2009).

### **5. Gıda Atığı ve Kaybını Azaltma Yöntemleri**

Gıda atığı ve kaybını azaltmak, gıda tedarik zincirinin her aşamasını içeren çok yönlü bir yaklaşım gerektirmektedir. Gıda atık ve kaybını azaltmaya yönelik stratejiler, depolama ve

taşıma uygulamalarının iyileştirilmesini, kozmetik standartlarının gevşetilmesini, fazla gıdanın gıda bankalarına ve hayır kurumlarına bağışlanmasını ve tüketicileri gıda israfını azaltmanın önemi konusunda eğitmeyi içermektedir. Diğer bir yenilikçi yaklaşım ise, bir sektördeki atığın başka bir sektörde kaynak olarak kullanıldığı döngüsel ekonomi ilkelerinin kullanılmasıdır. Birleşmiş Milletler'in Sürdürülebilir Kalkınma Hedefleri ve Avrupa Birliği'nin Tarladan Çatala stratejisi dahil olmak üzere gıda atıkları ve gıda kaybını ele almak için bir dizi küresel çaba bulunmaktadır (EC, 2020; FAO, 2020). Bu girişimler, tedarik zinciri yönetimini iyileştirerek, sürdürülebilir tüketimi teşvik ederek ve daha iyi eğitim ve farkındalık yoluyla gıda atığı ve gıda kaybını azaltmayı amaçlamaktadır. Mevcut çözümlere ek olarak, gıda israfını azaltmak için araştırılmakta ve geliştirilmekte olan potansiyel çözümler bulunmaktadır. Bunlar, gıda kalitesini ve tedarik zinciri lojistiğini izlemek için sensörler gibi tedarik zincirindeki israfı azaltmak için teknolojinin kullanımını ve daha sürdürülebilir ve daha uzun raf ömrüne sahip yeni gıda ürünleri ve ambalajların geliştirilmesini içermektedir. Gıda arz zincirinde gıda kayıp ve atıklarının azaltılmasında ambalajlama önemli bir yer tutmaktadır (Demirbaş, 2019). Diğer yenilikler arasında, gıdanın raf ömrünü uzatan yeni paketleme ve koruma tekniklerinin yanı sıra gıda atıklarının anaerobik çürütme (Edwards ve ark., 2017), biyoyakıt (Bastidas-Oyanedel ve ark., 2016), hayvan yemi ve kompostlama (Choy ve ark., 2015) gibi uygulamalar ile değerlendirilmesi yer almaktadır.

Gıda atık ve kayıpları doğrudan hayvan yemi olarak veya dehidrasyon, silaj, sıvı besleme vb. gibi bir ön işlem aşamasından sonra kullanılabilir (Kawashima, 2002). Ayrıca zeytinyağı artıkları ve peynir altı suyu tarımda gübreleme amaçlı kullanılabilir (Ayhan ve Kulaz, 2016; Deniz ve Hiç, 2019). Bunun yanında balık sanayi atıklarının gıda katkı maddesi ve antimikrobiyal madde olarak kullanıldığı bilinmektedir (Yağcı ve ark., 2006). Anaerobik çürütme, atık malzemelerin kullanılabilir gaz ve elektriğe dönüştürülmesi işlemidir (Pavi ve ark., 2017). Gıda atık ve kayıpları eklendiğinde metan üretimi artabilmektedir (Koch ve ark., 2015; Fitamo ve ark., 2016). Gıda atık ve kayıpları yüksek oranda organik madde ve nem içeriğine sahip olduğundan kolayca bozulabilmektedir (Chang ve Hsu, 2008). Bundan dolayı kompostlaştırma gıda atık ve kayıplara yönelik çevre dostu ve etkili bir yönetim seçeneğidir (Bernal ve ark., 2009; Choy ve ark., 2015). Fosil kaynakların sınırlı olması gerçeğiyle birlikte artan küresel nüfusun enerji gereksinimlerini karşılama zorluğu, alternatif kaynakların kullanımını zorunlu hale getirmiştir (Rathore ve ark., 2016). Biyobozunur atıklar bu açıdan alternatif bir kaynak olarak görünmektedir (Li ve ark., 2016). Araştırmalar gıda atık ve kayıplarının çeşitli işlemler yoluyla kullanılabilir ısıya, elektriğe, yakıt ve kimyasallara dönüştürülebileceğini göstermektedir (Ravindran ve Jaiswal, 2016). Örneğin, gıda atık ve kayıplarından türetilen etanol, fosil yakıtların yerini alma potansiyeline sahiptir (Bastidas- Oyanedel ve ark., 2016).

## **6. Gıda Atığı ve Kaybını Azaltmanın Faydaları**

Gıda atık ve kayıplarını azaltmanın çevre, toplum ve ekonomi için birçok faydası bulunmaktadır. Gıda israfını azaltarak kaynaklar korunabilir ve sera gazı emisyonları azaltılarak iklim değişikliğine karşı mücadeleye katkı sağlanabilmektedir. Ek olarak, gıda israfını azaltmak, gıda güvencesizliğini gidermeye yardımcı olabilmektedir. Son olarak, işletmeler gıda maliyetlerinden tasarruf sağlayıp bu tasarrufları tüketicilere aktarabileceğinden, gıda israfını azaltmanın ekonomik faydaları da bulunmaktadır.

## **7. Sonuç ve Öneriler**

Gıda atıkları ve kayıpları, önemli çevresel, sosyal ve ekonomik sonuçları olan karmaşık bir sorundur. Gıda israfını ele almak, gıda tedarik zincirinin her seviyesindeki değişiklikleri içeren çok yönlü bir yaklaşım gerektirmektedir. Gıda israfını azaltarak kaynaklar korunabilir, sera gazı emisyonları azaltılabilir ve gıda güvencesizliği ile mücadele edilebilir. Ek olarak, işletmeler gıda maliyetlerinden tasarruf edebilir ve tüketiciler daha düşük fiyatlardan gıda satın alabilir. Bu nedenle, gıda israfını azaltma çabalarına toplumun her düzeyinde öncelik verilmesi çok önemlidir. Depolama ve işleme uygulamalarının iyileştirilmesi, fazla gıdanın bağışlanması ve tüketicilerin eğitilmesi gibi mevcut çözümler, gıda israfını azaltmaya yönelik önemli adımlardır. Bununla birlikte, gıda israfını daha da azaltmak ve daha sürdürülebilir bir gıda sistemi oluşturmak için yeni teknolojilerin, ürünlerin ve politikaların sürekli araştırılmasına ve geliştirilmesine de ihtiyaç vardır. Gıda atık ve gıda kaybını azaltma çabalarına, hükümetlerden işletmelere ve bireysel tüketicilere kadar toplumun her düzeyinde öncelik verilmelidir. Birlikte çalışarak daha sürdürülebilir bir gıda sistemi oluşturabilir ve gıda atık ve gıda kaybının çevre, toplum ve ekonomi üzerindeki olumsuz etkilerini azaltabiliriz. Sonuç olarak, gıda güvencesini sağlamak, sürdürülebilir kalkınmayı desteklemek ve 21. yüzyılın zorluklarını ele almak için gıda atıklarını ve gıda kaybını azaltmak çok önemlidir.

## **KAYNAKLAR**

Ayhan, H., Kulaz, H. (2016). Peynir Altı Suyu ve Zeytinyağı Atıklarının Tarımda Gübreleme Amaçlı Kullanılabilirliği. *Tarla Bitkileri Merkez Araştırma Enstitüsü Dergisi*, 25(Özel Sayı-1), 311-316.

Barrett, J., Scott, K. (2012). Link between climate change mitigation and resource efficiency: a UK case study. *Glob. Environ. Change* 22 (1), 299e307.

Bastidas-Oyanedel, J.B., Fang, C., Almardeai, S., Javid, U., Yousuf, A., Schmidt, J.E. (2016). Review: waste biorefinery in arid/semi-arid regions. *Bioresour. Technol.* 215, 21–28.

Bernal, M.P., Albuquerque, J.A., Moral, R. (2009). Composting of animal manures and chemical criteria for compost maturity assessment. A review. *Bioresour. Technol.* 100 (22), 5444–5453.

Bringezu, S., Bleischwitz, R. (2009). In: Bringezu, S., Bleischwitz, R. (Eds.), *Sustainable Resource Management: Global Trends, Visions and Policies*. Greenleaf Publishing, Sheffield.

Buzby, J.C., Hyman, J. (2012). Total and per capita value of food loss in the United States. *Food Policy* 37 (5), 561–570.

Chang, J.I., Hsu, T.E. (2008). Effects of compositions on food waste composting. *Bioresour. Technol.* 99 (99), 8068–8074.



**4TH INTERNATIONAL LATIN AMERICAN  
CONGRESS ON NATURAL AND APPLIED SCIENCES**

Choy, S.Y., Wang, K., Qi, W., Wang, B., Chen, C.L., Wang, J.Y. (2015). Co-composting of horticultural waste with fruit peels, food waste, and soybean residues. *Environ. Technol.* 36 (11), 1448–1456.

COMCEC (2017). Reducing Food Waste in the OIC Countries. Standing Committee for Economic and Commercial Cooperation of the Organization of Islamic Cooperation (COMCEC). COMCEC Coordination Office, Ankara. 211 p.

Defra (2011). Government Review of Waste Policy in England 2011. London.

Demirbaş, N. (2019). Gıda arz zincirindeki kayıp ve israfın azaltılmasında ambalajın önemi ve gelişmeler. In International Balkan and Near Eastern Social Sciences Congress, Tekirdağ/Turkey (pp. 627-632).

Deniz, M. H., Hiç, Ö. (2019). Gıda Atıklarının Tarımda Gübre Olarak Kullanılabilme Olanakları Possibilities of Using Food Waste as Fertilizer in Agriculture.

Edwards, J., Othman, M., Crossin, E., Burn, S. (2017). Anaerobic co-digestion of municipal food waste and sewage sludge: a comparative life cycle assessment in the context of a waste service provision. *Bioresour. Technol.* 223, 237–249.

European Commission (EC) (2015). Closing the Loop-An EU Action Plan for the Circular Economy. Communication From the Commission to the European Parliament, the Council, the European Economic and Social Committee and the Committee of the Regions, COM(2015), 614 (2). European Commission (EC), Brussels.

European Commission (EC) (2020). Communication from the Commission to the European Parliament, the Council, the European Economic and Social Committee and the Committee of the Regions. A Farm to Fork Strategy for a fair, healthy and environmentally-friendly food system. COM 381.

Ferreira da Cruz, N., Simões, P., Cunha Marques, R. (2012). Economic cost recovery in the recycling of packaging waste: the case of Portugal. *J. Clean. Prod.* 37, 8e18.

Fitamo, T., Boldrin, A., Boe, K., Angelidaki, I., Scheutz, C. (2016). Co-digestion of food and garden waste with mixed sludge from wastewater treatment in continuously stirred tank reactors. *Bioresour. Technol.* 206, 245–254.

Food and Agriculture Organization (FAO) (1981). Food Loss Prevention in Perishable Crops. Rome: Food and FAO Agricultural Service Bulletin, no. 43, FAO Statistics Division.

Food and Agriculture Organization (FAO) (2014). Food wastage footprint- full-cost accounting- final report.

Food and Agriculture Organization (FAO) (2015). Food wastage footprint & climate change.

Food and Agriculture Organization (FAO) (2019a). The State of Food and Agriculture. Moving forward On Food Loss and Waste Reduction. FAO, Rome, Italy.



**4TH INTERNATIONAL LATIN AMERICAN  
CONGRESS ON NATURAL AND APPLIED SCIENCES**

Food and Agriculture Organization (FAO) (2019b). Key Facts on Food Loss and Waste You Should Know.

Food and Agriculture Organization (FAO) (2019c). Food waste refers to the decrease in the quantity or quality of food resulting from decisions and actions by retailers, food service providers and consumers.

Food and Agriculture Organization (FAO) (2020). Sustainable Development Goals. FAO, Rome, Italy.

Food and Agriculture Organization (FAO) (2022). What is food loss and food waste?

FoodDrinkEurope (2020). What is food wastage?

FUSIONS (2016). Food Waste Quantification Manual to Monitor Food Waste Amounts and Progression EU Project Fusions, Reducing Food Waste Through Social Innovation. Grant Number: 311972, 166 p.

Garnett, T. (2014). Three perspectives on sustainable food security: efficiency, demand restraint, food system transformation. What role for life cycle assessment? *J. Clean. Prod.* 73 (15), 10–18.

Gjerris, M., Gaiani, S. (2013). Household food waste in Nordic countries: estimations and ethical implications. *Nordic J. Appl. Ethics* 7 (1), 6–23.

Godfray, H.C.J., Beddington, J.R., Crute, I.R., Haddad, L., Lawrence, D., Muir, J.F., Pretty, J., Robinson, S., Thomas, S.M., Toulmin, C. (2010). Food security: the challenge of feeding 9 billion people. *Science* 327 (5967), 812–818.

Godfray, H.C.J., Garnett, T. (2014). Food security and sustainable intensification. *Philos. Trans. R. Soc. B: Biol. Sci.* 369 (1639).

Gustavsson, J., Cederberg, C., Sonesson, U., Emanuelsson, A. (2013). The Methodology of the FAO Study: “Global Food Losses and Food Waste – Extent, Causes and Prevention” – FAO, 2011. The Swedish Institute for Food and Biotechnology. SIK Report No. 857.

Gustavsson, J., Cederberg, C., Sonesson, U., Otterdijk, R., Meybeck, A. (2011). Global Food Losses and Food Waste. Food and Agriculture Organization, Rome, Italy.

Hall, K.D., Guo, J., Dore, M., Chow, C.C. (2009). The progressive increase of food waste in America and its environmental impact. *PLoS One* 4 e7940.

HLPE (2014). Food Losses and Waste in the Context of Sustainable Food Systems A report by the High Level Panel of Experts on Food Security and Nutrition of the Committee on World Food Security, Rome, 117 p.

Kawashima, T. (2002). The use of food waste as a protein source for animal feed – current status and technological development in Japan. In: *FAO Animal Production and Health*

**4TH INTERNATIONAL LATIN AMERICAN  
CONGRESS ON NATURAL AND APPLIED SCIENCES**

Proceedings: Protein Sources for the Animal Feed Industry-Expert Consultation and Workshop.

Koch, K., Helmreich, B., Drewes, J.E. (2015). Co-digestion of food waste in municipal wastewater treatment plants: effect of different mixtures on methane yield and hydrolysis rate constant. *Appl. Energy* 137, 250–255.

Lebersorger, S., Schneider, F. (2011). Discussion on the methodology for determining food waste in household waste composition studies. *WasteManag.* 31 (9/10), 1924–1933.

Li, H., Tian, Y., Zuo, W., Zhang, J., Pan, X., Li, L., Su, X. (2016). Electricity generation from food wastes and characteristics of organic matters in microbial fuel cell. *Bioresour. Technol.* 205, 104–110.

Lipinski, B., Hanson, C., Lomax, J., Kitinoja, L., Waite, R., Searchinger, T. (2013). *Reducing Food Loss and Waste World Resources Institute, Working Paper, Installment 2 of Creating a Sustainable Food Future.* Washington, DC.

McLaughlin, D., Kinzelbach, W. (2015). Food security and sustainable resource management. *Water Resour. Res.* 51, 4966e4985.

Morone, P., Koutinas, A., Gathergood, N., Arshadi, M., & Matharu, A. (2019). Food waste: Challenges and opportunities for enhancing the emerging bio-economy. *Journal of cleaner production*, 221, 10-16.

Papargyropoulou, E., Lozano, R., Steinberger, J. K., Wright, N., & bin Ujang, Z. (2014). The food waste hierarchy as a framework for the management of food surplus and food waste. *Journal of cleaner production*, 76, 106-115.

Pavi, S., Kramer, L.E., Gomes, L.P., Miranda, L.A.S. (2017). Biogas production from codigestion of organic fraction of municipal solid waste and fruit and vegetable waste. *Bioresour. Technol.* 228, 362–367.

Pinstrup-Andersen, P. (1999). Towards ecologically sustainable world food production. *Ind. Environ.* 22 (2e3), 10e13.

Rathore, A.S., Chopda, V.R., Gomes, J. (2016). Knowledge management in a waste based biorefinery in the QbD paradigm. *Bioresour. Technol.* 215, 63–75.

Ravindran, R., Jaiswal, A.K. (2016). A comprehensive review on pre-treatment strategy for lignocellulosic food industry waste: challenges and opportunities. *Bioresour. Technol.* 199, 92–102.

Salihoglu, G., Salihoglu, N. K., Ucaroglu, S., & Banar, M. (2018). Food loss and waste management in Turkey. *Bioresource technology*, 248, 88-99.

Schneider, F. (2013). Review of food waste prevention on an international level. *Waste Resour. Manag.* 166 (4), 187–203.

**4TH INTERNATIONAL LATIN AMERICAN  
CONGRESS ON NATURAL AND APPLIED SCIENCES**

Stuart, T. (2009). Waste. Uncovering the Global Food Scandal. Penguin, London.

Tahmaz, G. S., & Aksoy, M. (2022). Gıda İsrافی, Gıda Kaybı ve Gıda Atığı Üzerine Kavramsal Bir İnceleme (A Conceptual). Journal of Tourism and Gastronomy Studies, 10(2), 944-956.

Tarım ve Orman Bakanlığı (2015). Ekmek İsrافی. Erişim adresi: <https://kutahya.tarimorman.gov.tr/Belgeler/Ekmek%20%C4%B0sraf%C4%B1.pdf>

Tatlidil, F.F., Dellal, I., Bayramoglu, Z. (2013). Food Losses and Waste in Turkey. Food and Agriculture Organization of the UN, “Food Losses and Waste in Europe and Central Asia” component of the Agrarian Structures Initiative, a regional program of FAO in Europe and Central Asia, 71 p.

The World Bank (2016). Total greenhouse gas emissions (kt of CO2 equivalent).

Thyberg, K. L., & Tonjes, D. J. (2016). Drivers of food waste and their implications for sustainable policy development. Resources, Conservation and Recycling, 106, 110-123.

Thyberg, K.L., Tonjes, D.J. (2015). A management framework for municipal solidwaste systems and its application to food waste prevention. Systems 3 (3),133–151.

Tilman, D., Fargione, J., Wolff, B., D’Antonio, C., Dobson, A., Howarth, R., Schindler,D., Schlesinger, W.H., Simberloff, D., Swackhamer, D. (2001). Forecasting agriculturally driven global environmental change. Science 292 (5515),281–284.

United Nations (UN) (2015). Resolution adopted by the General Assembly on 25 September 2015. Transforming our world: the 2030 Agenda for Sustainable Development.

United Nations Environment Programme (UNEP) (2009). In: Nellemann, C., MacDevette, M., Manders, T., Eickhout, B., Svihus, B., Prins, A.G., et al. (Eds.), The Environmental Food Crisis-the Environment’s Role in Averting Future Food Crises. UNEP, Norway.

United Nations Environment Programme (UNEP) (2011). Decoupling Natural Resource Use and Environmental Impacts from Economic Growth. United Nations Environment Programme, Paris.

United Nations Human Settlements Programme (UNHSP) (2010). Solid Waste Management in the World’s Cities. London.

United States Environmental Protection Agency (USEPA) (2014). MSW in the United States: 2012 Facts and Figures. USEPA, Washington, DC, USA.

Williams, H.F., Wikstrom, T., Otterbring, M., Lofgren, A., Gustafsson, A. (2012). Reasons for household food waste with special attention to packaging. J. Clean. Prod. 24, 141e148.

Yağcı, S., Altan, A., Göğüş, F., Maskan, M. (2006). Gıda atıklarının alternatif kullanım alanları. Türkiye, 9, 24-26.

**Alptekin Mert YILMAZ**

Arş. Gör., Kocaeli Üniversitesi

ORCID NO: 0000-0002-7062-4770

**Abdullah ÇAĞLAR**

Prof. Dr., Kocaeli Üniversitesi

ORCID NO: 0000-0001-7216-8361

**Oktay TOMAR**

Doç. Dr., Kocaeli Üniversitesi

ORCID NO: 0000-0001-5761-7157

**ÖZET**

Tarım ve gıda endüstrisinde ileri dönüşüm, atıkları veya yan ürünleri katma değerli ürünlere dönüştürme sürecini ifade etmektedir. Bu yaklaşım sadece atıkları azaltmakla kalmaz, aynı zamanda sürdürülebilir kalkınmaya da katkıda bulunmaktadır. Bu çalışmanın amacı, tanımı, faydaları, zorlukları, çeşitli sektörlerdeki uygulamaları ve gelecekteki yönleri dahil olmak üzere ileri dönüşüm konusunu incelemektir. İleri dönüşüm, tarım ve gıda değer zincirinin farklı aşamalarında uygulanabilmektedir. Örneğin, tarımda mahsul artıkları, hayvan gübresi ve gıda işleme yan ürünleri gibi organik atıklar gübre, hayvan yemi ve biyoenerjiye dönüştürülebilmektedir. Gıda endüstrisinde, yenilebilir yan ürünler ve satılmamış gıdalar gibi gıda atıkları, hayvan yemi, biyoenerji veya yeni gıda ürünleri için bileşenlere dönüştürülebilmektedir. İleri dönüşüm, meyve ve sebzelerin posası ve kabuğu gibi yeterince kullanılmayan veya değeri düşük bileşenlerden yenilikçi gıda ürünleri oluşturmak için de kullanılabilir. Tarım ve gıda endüstrisinde ileri dönüşümün faydaları çoktur. İlk olarak, ekonomik, sosyal ve çevresel etkileri olan atıkları azaltmaktadır. Atıkları azaltmak, bertaraf maliyetlerini düşürmeye, yeni iş fırsatları yaratmaya ve atıktan kaynaklanan sera gazı emisyonlarını azaltmaya yardımcı olabilmektedir. İkincisi, ileri dönüşüm, kaynakların daha verimli kullanıldığı ve atıkların en aza indirildiği döngüsel ekonomiye katkıda bulunabilmektedir. Üçüncüsü, ileri dönüşüm, endüstrinin ekonomik sürdürülebilirliğine katkıda bulunan yeni gelir akışları ve katma değerli ürünler yaratabilmektedir. Dördüncüsü, ileri dönüşüm, atıkların yerel olarak geri dönüştürüldüğü ve yerel katma değerli ürünler oluşturmak için kullanıldığı yerel gıda sistemlerini teşvik edebilmektedir. Bununla birlikte,

## 4TH INTERNATIONAL LATIN AMERICAN CONGRESS ON NATURAL AND APPLIED SCIENCES

tarım ve gıda endüstrisindeki ileri dönüşüm de bazı zorluklarla karşı karşıyadır. Ana zorluklardan biri, atıkları toplamak, işlemek ve katma değerli ürünlere dönüştürmek için altyapı ve teknoloji eksikliğidir. İleri dönüşüm aynı zamanda çiftçiler, işleyiciler ve perakendeciler gibi değer zincirindeki farklı aktörler arasında başarılması zor olabilecek iş birliğini gerektirmektedir. Diğer bir zorluk da, atıkların hayvan yemi gibi belirli uygulamalarda kullanılmasını engelleyebilecek düzenleyici çerçevedir. Ayrıca, bazı tüketiciler atıklardan veya yan ürünlerden yapılan gıda ürünlerini tüketmek konusunda tereddütlü olabileceğinden, ileri dönüşüm tüketici kabul sorunlarıyla karşılaşabilmektedir. Zorluklara rağmen, tarım ve gıda endüstrisindeki ileri dönüşüm, gelecek vaat etmektedir. Sürdürülebilir ve etik gıda ürünlerine yönelik artan talep, ileri dönüştürülmüş gıda ürünlerinin geliştirilmesini sağlayabilir. Döngüsel ekonomi ilkelerine artan ilgi, sektörde ileri dönüşümün benimsenmesini de teşvik edebilir. Biyorafineriler gibi yeni teknolojilerin geliştirilmesi, atığın katma değerli ürünlere dönüştürülmesini de kolaylaştırabilir. Ayrıca ileri dönüşüm, atıkları azaltarak, yeni iş fırsatları yaratarak ve sürdürülebilir tüketim ve üretim modellerini teşvik ederek Sürdürülebilir Kalkınma Hedeflerine ulaşılmasına katkıda bulunabilir. Sonuç olarak, tarım ve gıda endüstrisindeki ileri dönüşüm, atık azaltma, döngüsel ekonomi, ekonomik sürdürülebilirlik ve yerel gıda sistemleri zorluklarını ele alma potansiyeline sahiptir. Bununla birlikte, altyapı ve teknoloji eksikliği, düzenleyici engeller ve tüketici kabulü gibi zorluklarla da karşı karşıyadır. Bu zorlukların üstesinden gelmek ve ileri dönüşümün potansiyelini tam olarak gerçekleştirmek için, değer zincirindeki farklı aktörler arasında iş birliğine dayalı çabalar, destekleyici politikalar ve halkı bilinçlendirme kampanyaları gereklidir. İleri dönüşüm, Sürdürülebilir Kalkınma Hedeflerine ulaşılmasına ve daha sürdürülebilir ve dayanıklı bir tarım ve gıda sisteminin oluşturulmasına katkıda bulunabilir.

**Anahtar kelimeler:** İleri dönüşüm, Tarım, Gıda.

### ABSTRACT

Upcycling in the agriculture and food industry refers to the process of repurposing waste or by-products into value-added products. This approach not only reduces waste but also contributes to sustainable development. The purpose of this study is to examine the topic of upcycling, including its definition, benefits, challenges, applications in various industries, and future directions. Upcycling can be applied in different stages of the agricultural and food value chain. For example, in agriculture, organic waste such as crop residues, animal manure, and food processing by-products can be transformed into fertilizers, animal feed, and bioenergy. In the food industry, food waste, such as edible by-products and unsold food, can be transformed into ingredients for animal feed, bioenergy, or new food products. Upcycling can also be used to create innovative food products from underutilized or undervalued ingredients, such as pulp and peel from fruits and vegetables. The benefits of upcycling in the agriculture and food industry are numerous. First, it reduces waste, which has economic, social, and environmental implications. Reducing waste can help cut disposal costs, create new business opportunities, and reduce greenhouse gas emissions from waste. Second, upcycling can contribute to the circular economy, where resources are used more efficiently,

and waste is minimized. Third, upcycling can create new revenue streams and value-added products, contributing to the economic sustainability of the industry. Fourth, upcycling can promote local food systems, where waste is recycled locally and used to create local value-added products. However, upcycling in the agriculture and food industry also faces some challenges. One of the main challenges is the lack of infrastructure and technology to collect, process, and transform waste into value-added products. Upcycling also requires collaboration between different actors in the value chain, such as farmers, processors, and retailers, which can be challenging to achieve. Another challenge is the regulatory framework, which may hinder the use of waste in certain applications, such as animal feed. Moreover, upcycling may face consumer acceptance issues, as some consumers may be hesitant to consume food products made from waste or by-products. Despite the challenges, upcycling in the agriculture and food industry has promising future prospects. The increasing demand for sustainable and ethical food products can drive the development of upcycled food products. The growing interest in circular economy principles can also promote the adoption of upcycling in the industry. The development of new technologies, such as biorefineries, can also facilitate the transformation of waste into value-added products. Furthermore, upcycling can contribute to achieving the Sustainable Development Goals by reducing waste, creating new business opportunities, and promoting sustainable consumption and production patterns. In conclusion, upcycling in the agriculture and food industry has the potential to address the challenges of waste reduction, circular economy, economic sustainability, and local food systems. However, it also faces challenges such as the lack of infrastructure and technology, regulatory barriers, and consumer acceptance. To overcome these challenges and fully realize the potential of upcycling, collaborative efforts between different actors in the value chain, supportive policies, and public awareness campaigns are needed. Upcycling can contribute to achieving the Sustainable Development Goals and creating a more sustainable and resilient agriculture and food system.

**Keywords:** Upcycling, Agriculture, Food.

## 1. GİRİŞ

Gıda kaybı ve gıda atığı hem gelişmiş hem de gelişmekte olan ülkeleri etkileyen küresel bir sorundur. Üretim, işleme, nakliye ve dağıtım sırasında kaybolan veya tüketiciler, perakendeciler ve diğer son kullanıcılar tarafından atılan yenilebilir gıda miktarı gıda kaybı ve gıda atığı olarak tanımlanmaktadır (Blakeney, 2019). Dünya genelinde her yıl yaklaşık 1.3 milyar ton (üretilen gıdanın üçte biri) gıdanın kayıp olduğu veya atık olduğu tahmin edilmektedir (Gustavsson ve ark., 2011; 2013). Gıda atıklarının sera gazı emisyonları da dahil olmak üzere çevresel birçok etkiye sebep olmasının yanında üretim maliyetlerini artırması ve potansiyel gelir kaybına yol açması gibi olumsuz ekonomik etkileri bulunmaktadır (Munesue ve ark., 2015). Ayrıca, gıda israfı erişilebilir gıda miktarının azalmasına yol açarak küresel gıda güvencesizliğinin de artmasına yol açmaktadır (Irani ve ark., 2018; Santeramo ve Lamonaca, 2021). Gıda kaybı ve atıklarının nedenleri arasında gıda tedarik zincirindeki verimsizlikler, tüketici davranış ve beklentilerindeki değişiklikler ve bazı bölgelerde altyapı ve teknoloji eksiklikleri yer almaktadır. Artan küresel nüfus ve artan gıda talebi ile birlikte bu faktörler, gıda kaybı ve atıkları ciddi bir sorun olarak gündeme



## 4TH INTERNATIONAL LATIN AMERICAN CONGRESS ON NATURAL AND APPLIED SCIENCES

taşımaktadır (Aschemann-Witzel ve ark., 2015; Blakeney, 2019; Morone ve ark., 2019). Gıda atıklarının ve kayıplarının önlenmesinde ileri dönüşüm son yıllarda ön plana çıkmıştır.

İleri dönüşüm, atık veya istenmeyen malzemelerin yeni, kullanışlı ürünlere dönüştürmeye yarayan sürdürülebilir bir süreçtir. İleri dönüşüm sayesinde atık miktarı azalmakta, mevcut malzemelerin yenisini üretmek yerine tekrar kullanarak doğal kaynaklar korunmaktadır (Sung ve Sung, 2015). İleri dönüşüm, çöpü hazineye dönüştürmeye yarayan yaratıcı ve çevre dostu bir metottur. İleri dönüşüm ile eski giysiler, mobilyalar veya elektronik ürünler gibi atılan ürünlere yeni ürünlere dönüştürülmektedir. Örneğin, eski tişörtler yeniden kullanılabilir alışveriş çantalarına, kırılan mücevherler yeni sanat eserlerine, modası geçmiş elektronik cihazlar saatli radyolara dönüştürülebilir.

Bu çalışmada, ileri dönüşümün gıda kaybını ve gıda atığını azaltmadaki rolü ve daha sürdürülebilir bir gıda sistemi yaratma konusundaki yeri incelenecektir. Kaynakların korunması, sera gazı emisyonlarının azaltılması ve yeni ürün ve endüstrilerin yaratılması da dahil olmak üzere ileri dönüşümün faydalarına da değinilecektir. Ayrıca gıda endüstrisinde kullanılan çeşitli ileri dönüşüm teknikleri ve yöntemleri ortaya konulacaktır. Ek olarak ileri dönüşüm ile gıda kaybını ve gıda atığını azaltabilmek için aşılması gereken zorluklar incelenecektir. Son olarak, gıda endüstrisinde ileri dönüşümün geleceği ve teknoloji, hükümet, endüstri ve tüketicilerin ileri dönüşümün başarısındaki önemi de tartışılacaktır.

## 2. İLERİ DÖNÜŞÜM

### 2.1. İLERİ DÖNÜŞÜM NEDİR?



Şekil 1. İleri Dönüşüm

## 4TH INTERNATIONAL LATIN AMERICAN CONGRESS ON NATURAL AND APPLIED SCIENCES

İleri dönüşüm, atık malzemelerin yeni ve yüksek kaliteli ürünlere dönüştürülmesini içeren bir atık azaltma sürecidir (Sung ve Sung, 2015). Diğer bir tanımla ileri dönüşüm, atık malzemelere yeni bir hayat vermeyi ve bu malzemelerin çöp olmasını önlemeyi amaçlayan bir geri dönüşüm şeklidir. İleri dönüşüm, orijinal malzemelerden daha yüksek değere sahip yeni ürünler yaratmayı amaçladığı için geleneksel geri dönüşümden farklıdır. Bu farklılık, ürünlere yeni tasarımlar veya işlevsellikler eklenmesi, malzemelerin kalitesinin iyileştirilmesinden kaynaklanmaktadır. İleri dönüşüm ile atıkların en aza indirgenmesi ve kaynakların korunduğu dögüsel bir ekonomi amaçlanmaktadır.

### 2.2. İLERİ DÖNÜŞÜMÜN TARİHİ

İleri dönüşüm uygulaması veya atık malzemeleri yeni ve kullanışlı ürünlere dönüştürme süreci, yüzyıllar öncesine dayanan bir geçmişe sahiptir. İleri dönüşümün kökleri, insanların atık malzemeleri zorunluluktan dolayı yeniden değerlendirdiği antik çağ zamanlarına kadar uzanmaktadır. Bunun dışında 19. yüzyılda, Batı Amerika'da yiyecek ve su depolamak için eski viski fiçileri yeniden kullanılmaktaydı. Son yıllarda ileri dönüşüm, çevresel sürdürülebilirliğin sağlanması amacıyla yeniden popüler bir hale gelmiştir. İleri dönüşümün tarihi; antik çağ, sanayi devrimi, dünya savaşları, ikinci dünya savaşı sonrası ve çevre hareketi olmak üzere beş dönemde incelenebilmektedir (Zimring, 2016; 2017).



Şekil 2. Antik Çağda İleri Dönüşüm

Erken Uygarlık (Antik Çağ):

Yunan, Roma ve Çin'in eski uygarlıkları da dahil olmak üzere antik çağlarda insanlar, yeni nesnelere oluşturmak için hurda metal ve kırık çanak çömlek gibi atık malzemeleri kullandıklarından ileri dönüşümü ilk uygulayanlar arasında yer almaktadırlar.

Sanayi Devrimi:



## 4TH INTERNATIONAL LATIN AMERICAN CONGRESS ON NATURAL AND APPLIED SCIENCES

Sanayi Devrimi sırasında, insanların fabrikalardan ve madenlerden çıkan atık malzemeleri yeni ürünlere dönüştürmeye başlamasıyla ileri dönüşüm yaygınlaşmaya başlamıştır. Örneğin, hurda metalin eritilmesiyle yeni aletler ve makineler üretilmiştir.



Şekil 3. Dünya Savaşlarında ve Sonrasında İleri Dönüşüm Uygulamaları

### Dünya Savaşları:

Dünya Savaşları sırasında savaş şartlarından dolayı silah ve diğer askeri teçhizatların üretimi amacıyla hurda metaller toplanmış ve eritilmiştir.

### İkinci Dünya Savaşı Sonrası:

İkinci Dünya Savaşı'nı takip eden yıllarda, insanların yeni ürünler tüketmeye başlamasıyla birlikte ileri dönüşüm nispeten daha az uygulanmaya başlamıştır. Dünya savaşları sırasında kullanılan bazı malzemeler savaş sonrasında farklı alanlarda kullanılmıştır. Örneğin sedye olarak kullanılan malzemeler bahçe çiti olarak kullanılmaktadır (Şekil 3).

### Çevre Hareketi:

20. yüzyılın sonlarında, atıkların çevresel etkilerinin farkına varıldıkça ileri dönüşüme olan ilgi yeniden canlanmıştır. Günümüzde ileri dönüşüm atık azaltımı ve sürdürülebilirliği sağlama konusunda giderek yaygınlaşmaktadır.

## 2.3. İLERİ DÖNÜŞÜMÜN FAYDALARI

İleri dönüşümün, atıkları azaltmak, kaynakları korumak ve sera gazı emisyonlarını azaltmak dahil olmak üzere çok sayıda faydası bulunmaktadır. İleri dönüşüm, düzenli depolama alanlarına giden atık miktarını azaltmaya, doğal kaynakları korumaya ve üretim süreçlerinin çevresel etkisini azaltmaya yardımcı olmaktadır. Ek olarak, ileri dönüşüm

## 4TH INTERNATIONAL LATIN AMERICAN CONGRESS ON NATURAL AND APPLIED SCIENCES

sayesinde yeni ürünler ve endüstriler yaratılarak istihdam ve ekonomik faydalar sağlanmaktadır.

### **Çevresel faydalar:**

İleri dönüşüm, atıkları azaltır ve yenilerini üretmek yerine mevcut malzemeleri kullanarak doğal kaynakları korur. Bu sayede üretimin çevresel etkisini en aza indirmeye yardımcı olur ve atık bertarafı ile ilişkili sera gazı emisyonlarını azaltır.

### **Finansal tasarruf:**

İleri dönüşüm, yeni ürünler satın alma ihtiyacını azaltarak para tasarrufu sağlayabilir ve satın alınması zor veya pahalı olabilecek ürünler üretilebilir.

### **Yaratıcılığı teşvik eder:**

İleri dönüşüm, insanlara yaratıcılık konusunda fırsat sağlar. Bireyler hayal güçlerinin sınırları dahilinde atıkları yeni, faydalı ürünlere dönüştürebilir.

### **Yerel toplulukları destekler:**

İleri dönüşüm, yerel kaynaklı malzemelerin kullanımını teşvik ederek, ithal ürün ihtiyacını azaltarak ve sürdürülebilir malzemelerin kullanımını teşvik ederek yerel toplulukları desteklemektedir.

### **Sürdürülebilirliği teşvik eder:**

İleri dönüşüm, atıkları azaltan, doğal kaynakları koruyan ve çevreyi destekleyen sürdürülebilir bir uygulamadır. İleri dönüşüm, düzenli depolama alanlarına giden atık miktarını azaltarak daha sürdürülebilir bir gelecek yaratmaya yardımcı olur.

### **İstihdam fırsatları yaratır:**

İleri dönüşüm, özellikle sınırlı iş fırsatlarının olduğu topluluklarda istihdam fırsatları yaratabilir.

### **Atık azaltmayı destekler:**

İleri dönüşüm, üretilen atık miktarının azaltılmasına yardımcı olur, düzenli depolama alanlarına gönderilen atık miktarını azaltır ve atık bertarafının çevresel etkisini en aza indirir.

## 2.4. İLERİ DÖNÜŞÜMÜN ZORLUKLARI

İleri dönüşümün birçok avantajı olmasına rağmen, zaman ve emek, sınırlı kullanım alanı, finansal yatırım gerekliliği, sınırlı malzeme mevcudiyeti, kalite kontrol ve sınırlı pazar talebi gibi bazı dezavantajları da söz konusudur.

### **Zaman ve çaba:**

İleri dönüşüm genellikle zaman ve emek gerektirmektedir. Ayrıca emek yoğun bir şekilde uygulanması gerekebilir. Bazı ileri dönüşüm projelerinin tamamlanması, özellikle karmaşık veya özel beceriler gerektiriyorsa, uzun zaman alabilmektedir.

### **Sınırlı kullanım:**

Bazı ileri dönüştürülmüş ürünler, yeni muadilleri kadar dayanıklı veya pratik olmayabilir. Örneğin, ileri dönüştürülmüş bir sandalye, yeni bir sandalye kadar sağlam veya rahat olmayabilir. İleri dönüştürülmüş bir oyuncak, yeni bir oyuncakla aynı özelliklere veya değere sahip olmayabilir.

**Finansal yatırım:**

İleri dönüşüm, çeşitli araçlara, sarf malzemelerine ve malzemelere ihtiyaç duyulmasını gerektirmektedir. Bu durum finansal bir yatırım gerektirebilmektedir.

**Sınırlı malzeme mevcudiyeti:**

İleri dönüşüm için gerekli malzemeler her zaman mevcut olmayabilir. Malzemelerin kısıtlı olması ileri dönüşümü olumsuz etkileyebilmektedir.

**Kalite kontrol:**

İleri dönüşüm, ürünü oluşturan kişinin becerilerine bağlıdır. Bitmiş ürünün kalitesi büyük ölçüde değişkenlik gösterebilmektedir. İleri dönüştürülmüş tüm ürünlerin belli bir standartta olmasını sağlamak her zaman mümkün olmamaktadır.

**Sınırlı pazar talebi:**

Faydalarına rağmen, ileri dönüşümün yaygın bir çekiciliği olmayabilir ve ileri dönüştürülmüş ürünler için pazar sınırlı olabilir. Bu durum ileri dönüştürülmüş ürünlerin satılmasını zorlaştırabilmektedir.

## 2.5. İLERİ DÖNÜŞÜM ÖRNEKLERİ

Atık malzemelerin yeni ve kullanışlı ürünlere dönüştürülmesine yarayan ileri dönüşüm uygulamaları yaygın olarak mobilya, giysi, plastik şişe, lastik, cam kavanoz, kağıt, kutu ve palet gibi malzemeler ile gerçekleştirilmektedir.



Şekil 4. İleri Dönüşüm Örnekleri





Şekil 5. Araba Parçaları ile İleri Dönüşüm Örnekleri

**Mobilya:**

Eski mobilyalar yeniden kullanılabilir. Örneğin, eski bir şifonyer zımparalandıktan sonra benzersiz ve şık bir mobilya parçası oluşturmak için yeniden boyanabilir.

**Giyim:**

Artık giyilmeyen giysiler çanta, minder kılıfı, perde gibi yeni ürünlere dönüştürülebilmektedir.

**Plastik Şişeler:**

Plastik şişeler kesilerek kuş yemliklerine, saksılara ve hatta lambalara dönüştürülebilmektedir.

**Otomobil parçaları:**

Eski lastikler, salıncak ve oyun ekipmanlarına dönüştürülebilmektedir. Ayrıca lastiklerin bahçe mobilyası, masa ve saksı gibi çeşitli kullanım alanları da bulunmaktadır. Ayrıca araba motorları masaya, araba süspansiyon yayları masa ayaklarına ve araba turboları ampul duylarına dönüştürülebilmektedir.

**Cam Kavanozlar:**

Cam kavanozlar yiyecek, baharat ve diğer ev eşyaları için saklama kapları olarak kullanılabilir.

**Kâğıt:**

Eski gazete ve dergiler kağıt hamuruna ve hatta mücevhere dönüştürülebilmektedir.



**Kutular:**

Alüminyum kutular yeni kutulara dönüştürülebilir, kuş yemliklerine, mumluklara ve diğer dekoratif öğelere dönüştürülebilmektedir.

**Paletler:**

Ahşap paletler, sehpa ve raf üniteleri gibi mobilyalar oluşturmak için kullanılabilir.

## 2.6. GERİ DÖNÜŞÜM VE İLERİ DÖNÜŞÜM ARASINDAKİ FARK

Atık azaltımı ve sürdürülebilirliğe katkıda kullanılan iki yöntem olan geri dönüşüm ve ileri dönüşümün tanım, amaç, kullanılan malzeme, süreç ve nihai ürün bakımından farklılıkları bulunmaktadır.



Şekil 6. Geri Dönüşüm ve İleri Dönüşüm

**Tanım:**

Geri dönüşüm, atık maddeleri bileşenlerine ayırma ve bu parçaları yeni ürünler yapmak için kullanma işlemidir. İleri dönüşüm ise atık malzemelerin parçalanmadan alınarak yeni ve kullanışlı ürünlere dönüştürülmesidir.

**Amaç:**

Geri dönüşümün birincil amacı, depolama alanlarına giden atık miktarını azaltmak ve doğal kaynakları korumaktır. İleri dönüşümün birincil amacı, atık malzemelerden yeni ve faydalı ürünler yaratmaktır.

**Kullanılan Malzemeler:**

Geri dönüşüm genel olarak kağıt, plastik, cam ve metal gibi malzemeler ile gerçekleştirilmektedir. İleri dönüşüm ise giyim, mobilya ve hatta elektronik dahil olmak üzere çok çeşitli atık malzemeler ile yapılabilmektedir.

**Süreç:**

Geri dönüşüm, atık malzemelerin parçalanması ve işlenmesi için karmaşık ve enerji yoğun bir süreç gerektirmektedir. Öte yandan ileri dönüşüm, atık malzemeleri yeni ürünlere dönüştürmeyi içeren daha basit ve daha yaratıcı bir süreçtir.

**Nihai Ürünler:**

Geri dönüşüm sonucunda genel olarak orijinal malzemelerden daha düşük kalitede yeni ürünler üretilmektedir. İleri dönüşümde ise yüksek kaliteli ve benzersiz ürünler ortaya çıkmaktadır.

## **2.7. İLERİ DÖNÜŞÜMÜN GELECEĞİ**

**Teknolojinin Rolü:**

İleri dönüşümü daha kolay, daha verimli ve daha uygun maliyetli hale getirmek için yeni ve yenilikçi teknikler ve süreçler geliştirilmesinde teknoloji kritik bir rol oynayacaktır. Örneğin, malzeme bilimi ve mühendisliğindeki ilerlemeler yeni ve yüksek performanslı ileri dönüştürülmüş malzemelerin geliştirilmesine yol açabilirken, yapay zeka ve makine öğrenimindeki ilerlemeler ileri dönüşüm sürecini kolaylaştırmaya yardımcı olabilir. Üç boyutlu yazıcıların yaygınlaşmasıyla birlikte ileri dönüşümün de yaygınlaşacağı düşünülmektedir.

**Hükümetin ve Politikannın Rolü:**

Hükümet ve politika, ileri dönüşümün geleceğini şekillendirmede önemli bir rol oynayacaktır. Hükümetler, ileri dönüşümün gelişmesini teşvik eden politikalar ve teşvikler oluşturarak, ileri dönüşümü destekleyici bir ortam yaratılmasına yardımcı olabilir. Örneğin, hükümetler ileri dönüşümle uğraşan şirketler için vergi teşvikleri sağlayabilir. Ayrıca belirli ürün veya uygulamalarda ileri dönüştürülmüş malzemelerin kullanılmasını zorunlu kılan düzenlemeler getirilebilir.

**Endüstrinin ve Tüketicilerin Rolü:**

Son olarak, endüstri ve tüketiciler ileri dönüşümün geleceğinde önemli bir rol oynayacaktır. Şirketlerin ileri dönüşümü operasyonlarına ve ürünlerine dahil etmede liderlik rolü üstlenmesi gerekecektir. Tüketicilerin ise bilinçli satın alma kararları vererek ileri dönüştürülmüş ürünleri talep etmesi ve desteklemesi gerekecektir. Tüketiciler çevreye karşı daha bilinçli hale geldikçe, ileri dönüştürülmüş malzemelerden yapılan ürünleri giderek daha fazla satın alacaktır. Bunun sonucunda sürdürülebilirliğe ve çevresel sorumluluğa öncelik veren şirketler tüketici satın alma davranışlarının kendilerine doğru yönelmesinin meyvelerini toplayacaktır.

## **2.8. FARKLI SEKTÖRLERDE İLERİ DÖNÜŞÜM ÖRNEKLERİ**

İleri dönüşüm, tarım, moda, inşaat ve gıda dahil olmak üzere birçok endüstri ve sektörde uygulanmaktadır. Örneğin, tarım sektöründe çiftçiler gıda atıklarını kompostlayabilir ve hayvan altlıklarını toprak iyileştirmek için yeniden kullanabilir. Moda endüstrisinde, tasarımcılar eski kıyafetleri yeni ve moda uygun tasarımlara dönüştürebilir. İnşaat

## 4TH INTERNATIONAL LATIN AMERICAN CONGRESS ON NATURAL AND APPLIED SCIENCES

sektöründe, inşaat malzemeleri yeniden kullanılabilir. Gıda sektöründe ise gıda atıkları yeni gıda ürünlerine dönüştürülebilir.

### 2.8.1. TARIM SEKTÖRÜNDE İLERİ DÖNÜŞÜM

Tarımda ileri dönüşüm uygulamaları arasında tarım sektöründeki atık malzemeleri yeniden kullanmayı sağlayan kompostlama, hayvan altıklarının değerlendirilmesi, plastik malçın yeniden kullanılması, yağmur suyu hasadı, kapların yeniden kullanılması ve ileri dönüşümlü tarım ekipmanları yer almaktadır.



Şekil 7. Tarım Sektöründe İleri Dönüşüm

#### **Kompostlama:**

Kompostlama, gıda artıkları ve bahçe atıkları gibi organik atıkları besin açısından zengin bir toprak besin maddesine dönüştürme işlemidir. Bu sayede, atıklar azaltılabilir ve toprak sağlığı iyileştirilerek daha verimli ürünler üretilebilir ve sentetik gübrelere olan ihtiyaç azaltılabilir.

#### **Hayvan Altıklarının Değerlendirilmesi**

Saman veya talaş gibi hayvan yatakları kompost haline getirilebilir ve toprak düzenleyici olarak kullanılabilir.

#### **Plastik Malçın Yeniden Kullanılması:**

Yabani otları bastırmak ve topraktaki nemi tutmak için kullanılan plastik malç tekrar kullanılabilir. Bu sayede atıklar azaltılır ve kaynaklar korunur.

#### **Yağmur Suyu Hasadı:**

Yağmur suyu toplanabilir ve sulama için kullanılabilir. Bu durum su ihtiyacının azaltılmasında etkilidir.



### İleri Dönüşümlü Tarım Ekipmanları:

Eski tarım ekipmanları yeniden kullanılabilir. Bu sayede atık azaltılabilir ve kaynaklar korunabilir. Ayrıca çeşitli malzemeler tarım sektöründe kullanılacak alet ve ekipmanlara dönüştürülebilmektedir (Şekil 7).

### 2.8.2. GIDA SEKTÖRÜNDE İLERİ DÖNÜŞÜM

Gıdalarda ileri dönüşüm, gıda atıklarının yeni ve lezzetli gıda ürünlerine dönüştürülmesi sürecidir. Gıdalarda ileri dönüşüm uygulamaları arasında kompostlama, çirkin/şekilsiz ürünlerin kullanılması, gıda atıklarının yeniden değerlendirilmesi, bira ve şarabın ileri dönüşümü ve gıda yan ürünlerinin kullanımı yer almaktadır.



Şekil 8. Gıdaların İleri Dönüşümü

#### **Kompostlama:**

Kompostlama, sebze ve meyve artıklarını bitkiler için zengin bir besin maddesine dönüştürme işlemidir. Bu sayede atıklar ve sentetik gübreye duyulan ihtiyaç azaltılır.

#### **Çirkin/Şekilsiz Ürünlerin Kullanılması:**

"Çirkin" veya şekilsiz olduğu düşünülen meyve ve sebzeler çorbalarda, güveçlerde ve pürelerde kullanılabilir. Bu sayede gıda israfı azaltılmış olur.

#### **Gıda atıklarının yeniden değerlendirilmesi:**

Gıda sektöründe, satılmamış gıdalar ve kabuklar dahil olmak üzere büyük miktarlarda atık oluşmaktadır. Gıda atıklarının ileri dönüştürülmesiyle atık miktarı azaltılır. Örneğin kahve telvesi kompost veya gübre olarak, ekmek atığı kırıntı veya kroton olarak kullanılabilir. Bayat

## 4TH INTERNATIONAL LATIN AMERICAN CONGRESS ON NATURAL AND APPLIED SCIENCES

ekmekler kroton ve galeta unu yapımında kullanılabilir. Olgunlaşmış meyveler reçel, jöle ve şurup üretiminde kullanılabilir.

### **Bira ve Şarabın İleri Dönüşümü:**

Bira ve şarap üretiminden elde edilen kullanılmış üzümler sirke, sürülebilir ürünler ve hatta köpek ödülleri gibi yeni gıda ürünlerine dönüştürülebilir.

### **Gıda yan ürünlerinin kullanılması:**

Fındık kabukları gibi gıda yan ürünleri, diğer gıda ürünleri için bileşenlere dönüştürülebilir, bu da israfı azaltır ve kaynakları korur. Örneğin, badem kabukları enerji üretimi için yakıt olarak veya yenilebilir mantar yetiştirmek için bir substrat olarak kullanılabilir.

### **2.8.3. MODADA İLERİ DÖNÜŞÜM**

Modada ileri dönüşümün bir örneği, eski giysilerin yeniden değerlendirilmesidir. Bu sayede eski kıyafetlerin yeni giyim eşyalarına dönüştürülmesi, ev eşyaları veya aksesuarlar gibi yeni ürünlerin oluşturulması sağlanabilmektedir. Moda endüstrisi, giysi ve aksesuar oluşturmak için geri dönüştürülmüş polyester kullanmak gibi, ürünlerinde geri dönüştürülmüş malzemeler kullanarak ileri dönüşüm gerçekleştirmektedir (Vadicherla ve ark., 2017; Marques ve ark., 2019).

### **2.8.4. İNŞAAT SEKTÖRÜNDE İLERİ DÖNÜŞÜM**

İnşaatta ileri dönüşümün bir örneği, tuğla, kereste ve metal gibi inşaat malzemelerinin yeni inşaat projelerinde yeniden kullanılmasıdır. İnşaat sektörü, döşeme ve yalıtım gibi yapı ürünlerinin üretiminde geri dönüştürülmüş malzemelerin kullanılması ile projelerinde ileri dönüşüm gerçekleştirmektedir (Gnatiuk ve ark., 2022). Ayrıca kargo konteynerleri ev yapımında kullanılabilir (Blandford ve Bender, 2020).

### **2.9. GIDA İSRAFINI AZALTMADA İLERİ DÖNÜŞÜMÜN ROLÜ**



Şekil 8. Gıda İsrafi ve İleri Dönüşüm

İleri dönüşüm, gıda israfını azaltmada önemli bir rol oynamaktadır (Mostaghian ve ark., 2021). Birleşmiş Milletler Gıda ve Tarım Örgütü'nün bir raporuna göre, dünya çapında üretilen tüm gıdaların yaklaşık üçte biri kaybolmakta veya atık olmaktadır. Bu miktar, her yıl 1,3 milyar tondan fazla gıda anlamına gelmektedir. Ayrıca gıda atıkları önemli çevresel, sosyal ve ekonomik etkilere yol açmaktadır. Yiyecekleri ileri dönüştürerek atıkları azaltabilir, yeni, lezzetli ve besleyici ürünler yaratabiliriz. Örneğin, olgunlaşmış meyve ve sebzeler reçel ve soslara, bayat ekmekler ise kroton veya ekmek kırıntılarına dönüştürülebilir. İleri dönüşüm, gıdanın raf ömrünün uzamasına da yardımcı olarak saklamayı kolaylaştırır ve israf olasılığını azaltır. İleri dönüşümün gıda israfını azaltabilmesinin bir başka yolu da, normalde atılacak olan gıdaları kullanmaktır. Örneğin, hafif kusurlu yiyecekler çorba, güveç ve smoothie gibi yeni ürünler oluşturmak için kullanılabilir. Bu durum sadece israfı azaltmakla kalmaz, aynı zamanda maliyeti de düşürmektedir. Gıda israfını azaltmanın yanı sıra, ileri dönüşümün başka çevresel faydaları da vardır. Düzenli depolama alanlarına gönderilen gıda atıklarının miktarını azaltarak sera gazı emisyonlarını azaltabilir ve doğal kaynakları koruyabiliriz. Yiyeceklerin ileri dönüştürülmesi ayrıca sürdürülebilir tarımı destekler. Ayrıca yerel kaynaklı ve mevsimlik malzemelerin kullanımı teşvik edilmiş olur.

## 2.10. TÜRKİYE'DE İLERİ DÖNÜŞÜM

Türkiye'de ileri dönüşüm yeni gelişmeye başlasa da atığın azaltılması ve sürdürülebilirliğin teşvik edilmesinde önemli bir etki yaratma potansiyeline sahiptir. Türkiye'de ileri dönüşümü teşvik etmek ve desteklemek için çalışan devlet kurumları, kar amacı gütmeyen kuruluşlar ve özel şirketler dahil olmak üzere birçok girişim ve kuruluş bulunmaktadır. Türkiye'de ileri dönüşümün bir örneği, giysi ve yatak takımı gibi eski tekstil ürünlerinin yeni ürünler ve malzemeler oluşturmak için yeniden kullanılmasıdır. Türkiye'deki çeşitli kuruluşlar eski tekstil ürünlerini toplayıp yeniden kullanmak, atıkları azaltmak ve kaynakları korumak ve aynı zamanda yeni işler ve ekonomik fırsatlar yaratmak için



çalışmaktadır. Türkiye'de ileri dönüşümün ivme kazandığı bir diğer alan da gıda endüstrisidir. Şirketler, hem fazla gıdalardan yeni ürünler geliştirerek hem de israfı en aza indirmek için tedarik zinciri ve dağıtım sistemlerini iyileştirerek gıda atıklarını yeniden kullanmak ve gıda kaybını azaltmak için çalışmaktadır. Bu çabalara rağmen, Türkiye'de ileri dönüşümün potansiyelini tam olarak gerçekleştirmek için aşılması gereken zorluklar var. Örneğin, ileri dönüşüm ve faydaları hakkında daha fazla farkındalık ve eğitimin yanı sıra ileri dönüşüm girişimlerinin büyümesini ve gelişimini desteklemek için araştırma ve geliştirmeye daha fazla yatırım yapılması gerekmektedir.

### **3. SONUÇ VE ÖNERİLER**

İleri dönüşüm, atıkları azaltmak, kaynakları korumak ve iklim değişikliğinin etkilerini azaltmak için önemli bir stratejidir. İleri dönüşüm, atılan veya istenmeyen malzemeleri yeni ve yararlı ürünlere dönüştürerek, sera gazı emisyonlarını azaltmak, yeni ürünler ve endüstriler yaratmak, istihdam ve ekonomik faydalar sağlamak dahil olmak üzere bir dizi çevresel, ekonomik ve sosyal fayda sağlamaktadır. Eski uygarlıklardan günümüze kadar ileri dönüşüm, atık azaltımı konusunda önemli bir yöntem olmuştur. Dünya, atık ve sürdürülebilirlikle ilgili artan zorluklarla karşı karşıya kalırken, bu sorunları ele almanın ve daha sürdürülebilir bir gelecek inşa etmenin bir yolu olarak ileri dönüşüm giderek daha önemli hale gelmektedir. İleri dönüşümün, zaman ve çaba gerektirmesi ile bazı ileri dönüştürülmüş ürünlerin sınırlı kullanım alanına sahip olması gibi bazı dezavantajları vardır. İleri dönüşüm konusunda, farkındalık ve eğitim eksikliği, teknik ve mali engeller ve kültürel ve sosyal tutumlar dahil olmak üzere zorluklar söz konusudur. İleri dönüşümün önündeki en büyük zorluklardan biri, bunun ne olduğu ve nasıl yapılacağı konusunda farkındalık ve eğitim eksikliğidir. Pek çok insan, ileri dönüşümün faydalarının veya mevcut çeşitli teknik ve yöntemlerin farkında değildir. Bundan dolayı eğitim yoluyla ileri dönüşüm hakkında farkındalık yaratmak önemlidir. İleri dönüşümün bir başka zorluğu da alet ve ekipmana ihtiyaç duyulmasından dolayı ortaya çıkan teknik ve mali engellerdir. Son olarak, kültürel ve sosyal tutumlar da ileri dönüşüme yönelik zorluklardan birisidir. İleri dönüştürülmüş ürünlerin kalitesi veya değeri hakkında olumsuz algılar söz konusu olabilir. Bunun üstesinden gelme konusunda yüksek kaliteli ileri dönüştürülmüş ürünleri sergileyerek kültürel ve sosyal tutumları değiştirmek faydalı olabilir. Daha fazla insan ileri dönüşümün faydalarını ve mevcut birçok teknik ve yöntemi öğrendikçe, ileri dönüşüm giderek yaygınlaşacak ve çevre ve toplum üzerindeki olumlu etkisi daha da artacaktır. Doğru destek ve yatırımla ileri dönüşüm atıkların azaltılmasında, kaynakların korunmasında ve iklim değişikliğinin etkilerinin hafifletilmesinde kritik bir rol oynama potansiyeline sahiptir.

### **KAYNAKÇA**

Aschemann-Witzel, J., De Hooge, I., Amani, P., Bech-Larsen, T., & Oostindjer, M. (2015). Consumer-related food waste: Causes and potential for action. *Sustainability*, 7(6), 6457-6477.

Blakeney, M. (2019). *Food loss and food waste: Causes and solutions*. Edward Elgar Publishing.

Blanford, M., & Bender, S. (2020). *Upcycling Shipping Containers for Houses*. *Cityscape*, 22(2), 95-100.

Gnatiuk, L., Novik, H., & Melnyk, M. (2022). *Recycling and upcycling in construction*.

**4TH INTERNATIONAL LATIN AMERICAN  
CONGRESS ON NATURAL AND APPLIED SCIENCES**

Gustavsson J, Cederberg C, Sonesson U, Emanuelsson A: The methodology of the FOA study: global food losses and food waste—extent, causes and prevention. Gothenburg, Sweden: The Swedish Institute for Food and Biotechnology; 2013:70

Gustavsson, J.; Cederberg, C.; Sonesson, U.; van Otterdijk, R.; Meybeck, A. Global Food Losses and Food Waste; FAO: Rome, Italy, 2011.

Irani, Z., Sharif, A. M., Lee, H., Aktas, E., Topaloğlu, Z., van't Wout, T., & Huda, S. (2018). Managing food security through food waste and loss: Small data to big data. *Computers & Operations Research*, 98, 367-383.

Marques, A. D., Moreira, B., Cunha, J., & Moreira, S. (2019). From waste to fashion—a fashion upcycling contest. *Procedia CIRP*, 84, 1063-1068.

Morone, P., Koutinas, A., Gathergood, N., Arshadi, M., & Matharu, A. (2019). Food waste: Challenges and opportunities for enhancing the emerging bio-economy. *Journal of cleaner production*, 221, 10-16.

Moshtaghian, H., Bolton, K., & Rousta, K. (2021). Challenges for upcycled foods: definition, inclusion in the food waste management hierarchy and public acceptability. *Foods*, 10(11), 2874.

Munesue, Y., Masui, T., & Fushima, T. (2015). The effects of reducing food losses and food waste on global food insecurity, natural resources, and greenhouse gas emissions. *Environmental Economics and Policy Studies*, 17, 43-77.

Santeramo, F. G., & Lamonaca, E. (2021). Food loss—food waste—food security: a new research agenda. *Sustainability*, 13(9), 4642.

Sung, K., & Sung, K. (2015). A review on upcycling: Current body of literature, knowledge gaps and a way forward.

Vadicherla, T., Saravanan, D., Muthu Ram, M., & Suganya, K. (2017). Fashion renovation via upcycling. *Textiles and clothing sustainability: Recycled and upcycled textiles and fashion*, 1-54.

Zimring, C. A. (2016). Upcycling in History: Is the Past a Prologue to a Zero-Waste Future? The Case of Aluminum. *RCC Perspectives*, (3), 45-52.

Zimring, C. A. (2017). *Aluminum upcycled: Sustainable design in historical perspective*. JHU Press.

**KUZEY ANADOLU FAYI VE DOĐU ANADOLU FAYINDA YAPILAN  
PALEOSİSMİK ARAŞTIRMALAR VE AKTİF FAYLARIN DEĐERLENDİRİLMESİ**

**PALEOSEISMIC STUDIES ON THE NORTH ANATOLIAN FAULT AND THE  
EAST ANATOLIAN FAULT AND EVALUATION OF ACTIVE FAULTS**

**Duygu TAŞKIN**

Duygu TAŞKIN: Sakarya Üniversitesi, Fen Bilimleri Enstitüsü., Sakarya

ORCID No: 0009-0008-9518-4995

**Günay BEYHAN**

Günay BEYHAN: Sakarya Üniversitesi, Müh.Fak.,Jeofizik Müh.Böl.Sakarya

ORCID No: 0000-0003-1341-9049.

**Özet**

Türkiye, Kuzey Anadolu Fayı (KAF) ile Doğu Anadolu Fayı (DAF)'nın etkisi altında tektonik olarak şekillenmektedir. KAF' da en son gerçekleşen 17 Ağustos ve 12 Kasım 1999 Kocaeli ve Düzce depremleri Türkiye'nin kuzeyinin ne denli aktif olduğuna işaret etmektedir. Benzer şekilde, 6-02-2023 günü DAF da meydana gelen 2 büyük depremde ülkemizin doğusunun oldukça büyük tektonizmaya sahip olduğunu göstermektedir. Dünyanın önemli fay sistemleri içinde yer alan Türkiye' de yapılacak paleosismolojik araştırmalar çok büyük öneme sahiptir. Paleosismolojik veriler ile herhangi bir fay sisteminde ki geçmiş deprem özellikleri (büyüklük, şiddet, fayın atımı ve tekrarlama periyodu) hakkında çok yararlı bilgilere ulaşılabilmektedir. KAF ve DAF boyunca jeolojik, jeomorfolojik ve paleosismolojik çalışmalar yaparak, eski büyük depremleri belirlemek ve parametrelerini ortaya koymak KAF' nın DAF' nın bölgedeki depremselliğini anlamak açısından büyük önem kazanmaktadır. Fay zonunun depremselliğinin iyi bilinmesi, gelecekte oluşacak olan büyük depremlerin mevcut insan yapıları üzerinde neden olacağı hasarları en aza indirmeye yönelik çalışmalara önemli katkılar sağlayacaktır. Bu çalışmada, KAF ile DAF da ki paleosismik araştırmalar derlenerek aktif faylar tespit edilmeye çalışılmıştır. Bu amaçla KAF ve DAF 'nın aktif segmentlerinde çok sayıda araştırmacı tarafından yapılan paleosismik araştırmaların belirli bir sistematiikle derlenerek istatistiki bir altlık oluşturmak hedeflenmiştir. Tespit edilen bu aktif fayların konumları ve geometrileri değerlendirilerek stres yüklenmiş ve gelecekte deprem üretme kapasitesine sahip segmentler belirlenmeye çalışılmıştır. Böylece, söz konusu bu segmentlerde eski tarihlerde oluşan depremlere ait yer değiştirme miktarı, ivme, muhtemel derinlik, sarsıntının şiddeti ve diğer parametreler belirli bir disiplinle derlenerek literatüre kazandırılmaya çalışılmıştır. KAF ve DAF birleşik (conjugate) faylardır. Bu tür fayların en tipik özelliği; biri aktif haldeyken diğerinin kilitlenmesidir. Dolayısı ile geçtiğimiz yüzyılda da KAF aktif haldeyken DAF'ın kilitlenmiş olduğu aletsel kayıtlardan anlaşılmıştır. Bütün bunlardan, DAF'ın içinde bulunduğumuz yüzyılda Ölü Deniz Fayı' na (ÖDF) doğru, KAF' nı ise önce Ege gerilme sistemini daha sonrasında da Marmara' da aktif hale geçeceğini ispat etmektedir.

**Anahtar kelimeler:** KAF, DAF ve Paleosismoloji

### **Abstract**

Turkey is shaped tectonically under the influence of the North Anatolian Fault (NAF) and the East Anatolian Fault (EAF). The most recent 17 August and 12 November 1999 Kocaeli and Düzce earthquakes in the NAF indicate how active the northern part of Turkey is. Similarly, the 2 major earthquakes that occurred in the EAF on 6-02-2023 show that the eastern part of our country has quite large tectonism. Paleoseismological researches to be carried out in Turkey, which is one of the most important fault systems of the world, are of great importance. With paleoseismological data, very useful information can be obtained about the past earthquake characteristics (magnitude, intensity, fault displacement and recurrence period) in any fault system. By carrying out geological, geomorphological and paleoseismological studies along the NAF and EAF, determining the old great earthquakes and revealing their parameters gain great importance in terms of understanding the seismicity of the NAF's EAF in the region. Knowing the seismicity of the fault zone well will make important contributions to the studies aimed at minimizing the damage to the existing human structures by the large earthquakes that will occur in the future. In this study, active faults were tried to be determined by compiling the paleoseismic surveys in the NAF and the EAF. For this purpose, it is aimed to create a statistical base by compiling the paleoseismic researches made by many researchers in the active segments of the NAF and EAF with a certain systematic. By evaluating the positions and geometries of these detected active faults, it was tried to determine the stress-loaded segments that have the capacity to produce earthquakes in the future. Thus, the displacement amount, acceleration, probable depth, intensity of the shaking and other parameters of the earthquakes that occurred in ancient times in these segments were compiled with a specific discipline and tried to be brought to the literature. NAF and EAF are conjugate faults. The most typical feature of such faults is; one is active while the other is locked. Therefore, it has been understood from the instrumental records that the DAF was locked while the NAF was active in the last century. From all these, it proves that the EAF will become active towards the Dead Sea Fault (ÖDF) in the current century, and the NAF will become active first in the Aegean tension system and then in the Marmara.

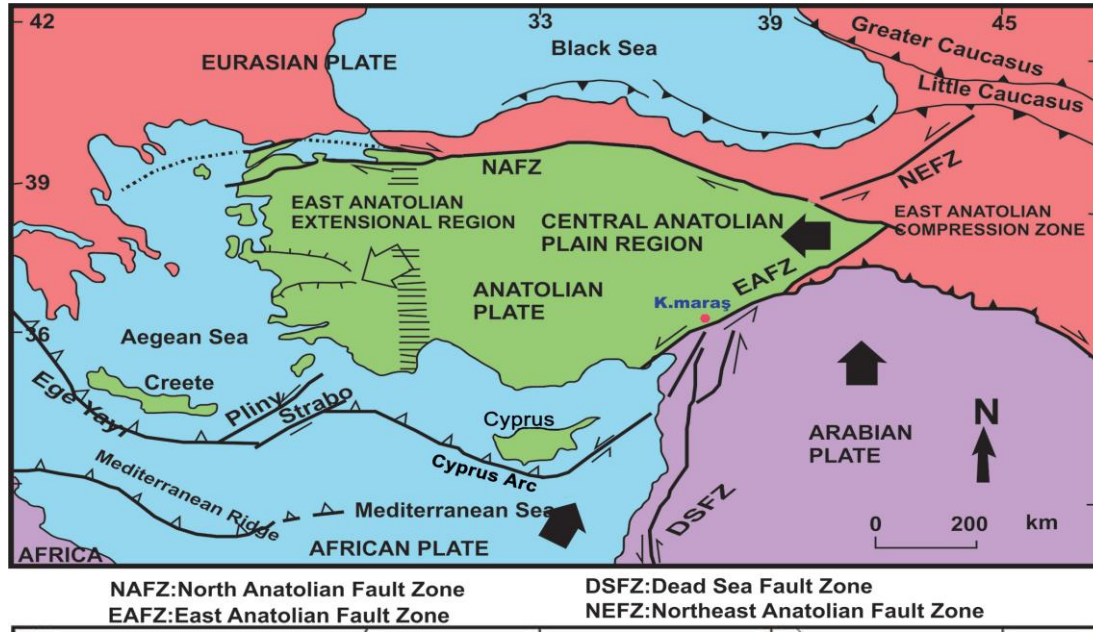
**Keywords:** NAF, EAF and Paleoseismology

### **Giriş**

Bu çalışma, KAF ve DAF üzerinde yapılmış olan çeşitli fay araştırmaları ile paleosismik araştırmaların yer aldığı bir derlemeden oluşmaktadır. Konu ile ilgili derlememiz devam ettiği için sadece KAF hakkında bilgi verilecektir. Bilindiği üzere KAF ve DAF, Türkiye'de büyük yıkıcı depremler üreten ve Dünya literatürüne geçmiş büyük sismik kaynaklardır. 20. yüzyılda Kuzey Anadolu Fay Zonunda (KAFZ) son 70 yılda mal ve can güvenliği açısından yıkıcı 8 büyük deprem ( $M > 7$ ) meydana gelmiştir. Ülkemizdeki büyük depremler, doğrultu-atımlı faylar tarafından üretilmektedir. Doğrultu atımlı faylar, önemli yüzey kırıkları ile sismik yer değiştirme meydana getirerek büyük depremler üreten çok tehlikeli tektonik yapılardır (Şekil-1). Jeolojik olarak Miyosen' den beri aktif olan ve sağ yönlü bu doğrultu-atımlı tektonik

**4TH INTERNATIONAL LATIN AMERICAN  
CONGRESS ON NATURAL AND APPLIED SCIENCES**

sistem doğudan batıya doğru sürekli bir deprem göçü ile canlılığını korumaktadır. Bu itibarla, 1939-1999 yılları arasında ortalama 60 yıllık bir zaman diliminde Erzincan'dan Marmara Denizi' ne kadar yaklaşık 1100 km' lik bir hareket meydana getirmiştir. GPS sistemi ile sürekli izlenen KAF boyunca, Anadolu bloğunun batıya doğru olan göç hareketinin ortalama hızı 17-26 mm/yıl arasında değişmektedir (Reilinger ve ark., 1997;2006). Ülkemizin ikinci önemli tektonik aktivitesini DAF meydana getirmektedir. Bu fay zonu, Bingöl-Karlıova' dan GB'ya doğru yönelerek Hatay ilimize kadar uzanmaktadır. Ortalama 450 km uzunluğa sahip olan DAF sol yönlü doğrultu atımlı hareket sergileyerek Lübnan'a doğru uzanan Ölü Deniz Fayı ile birleşmektedir. Arap levhası ile Anadolu levhasının sınırını da oluşturan DAF' nın günümüze kadar toplam 15-30 km atımı yaptığı anlaşılmaktadır (Çetin vd., 2003; Reilinger vd., 2006).



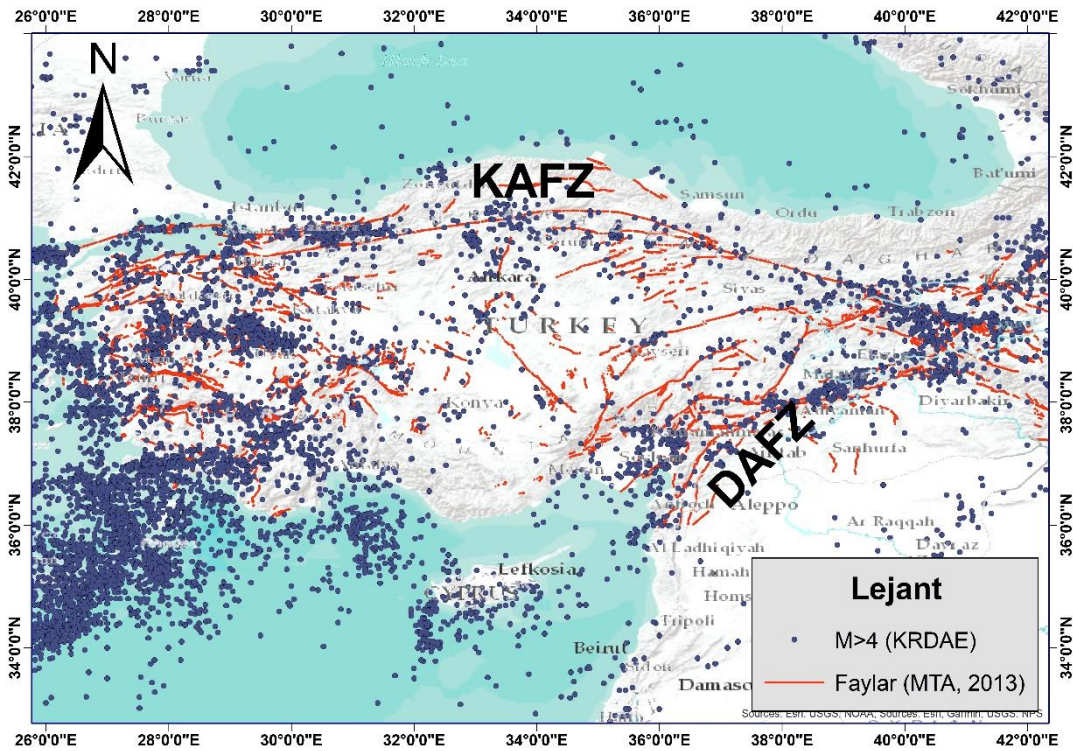
Şekil-1: Türkiye' deki Fay Sistemleri (Palutoğlu ve Şaşmaz, 2017)

Bu makalenin hazırlandığı esnada ne yazık ki bölge 10 ilimizi de kapsayacak büyüklükte iki büyük depremle sarsılmıştır. Mw=7.8 Kahramanmaraş-Pazarcık ve Mw=7.7 Kahramanmaraş-Elbistan depremleri cumhuriyet tarihinde görülmemiş bir yıkıma ve can kaybına neden olmuştur. Tarihsel kayıtlardan bu iki depremin kırdığı DAF segmentlerinin en az 500 yıldır tektonik gerilme biriktiren sismik boşluklar olduğunu göstermektedir (Ambraseys, 1989; Duman ve Emre, 2013).



## KAF' nın Aktivitesi ve Genel Özellikleri

KAF' nın aktivitesi ile ilgili çalışmalar 1999 yılındaki 17 Ağustos Kocaeli ve 12 Kasım Düzce depremlerinin ardından büyük ölçüde artmıştır; Bouchon ve ark., 2002; Barka ve ark., 2002; Akyüz ve ark., 2002, Hartleb ve ark., 2002, Pınar ve ark., 2001; Tibi ve ark., 2001; Aydın ve ark., 2002; Sekiguchi ve ark., 2002; Rockwell ve ark., 2002 (Şekil-2). Bununla birlikte, KAFZ ve civarındaki aktif tektonik yapılar çeşitli araştırmacılar tarafından çalışılmıştır. Çok sayıda segmentten oluşan KAF' nın ana kolu ile bağlantılı ve Anadolu' nun GB' ya doğru olan rotasyonunu meydana getiren çok sayıda faylar da yer almaktadır. Öte yandan, KAF içinden geçtiği Marmara Denizi, tektonik ve yapısal özelliklerinin belirlenmesi amacıyla derin deniz (sismik, gravite, vb) amaçlı gemiler tarafından da yoğun bir şekilde araştırılmıştır.



Şekil-2: KAF' nın 1900-2020 Dönemine ait Deprem Etkinliği (Emre Ö, et al.2013).

Bu araştırmalardan elde edilen batimetri, sismik yansıma ve diğer verilerin sonuçları Armijo ve ark., 2002 ve 2005; Le Pichon ve ark., 2001 ve 2003; İmren ve ark., 2001; Gazioğlu ve ark., 2002 gibi çok sayıdaki araştırmacılar tarafından paylaşılmıştır. Buna göre KAF' nın Marmara Denizi'n de ki genişlemesine bağlı olarak çek-ayır (pull-apart) adı verilen fay geometrisi sergilediği anlaşılmıştır (Uçarkuş ve ark., 2006;2008; Beyhan ve ark., 2009). Tarihsel depremler, eski yerleşim yerlerindeki kayıtlardan öğrenilmektedir. Bu açıdan bakıldığında Anadolu'nun uzun arkeolojik tarihi içinde tarihsel deprem kayıtlarının oldukça iyi bir şekilde belgelendiği anlaşılmaktadır (Ambraseys ve Jackson, 1998).



**4TH INTERNATIONAL LATIN AMERICAN  
CONGRESS ON NATURAL AND APPLIED SCIENCES**

Yer	Tarih	Enlem	Boylam	M (Büyükük)
Lâdik	236	40.9000	36.0000	-
Amasya	551	40.5500	35.8500	-
Kargı	968	41.1500	34.7500	-
Çorum	1075	40.6000	34.9500	-
Amasya	1415	40.6500	35.8500	-
Tosya	1419	41.0000	34.0000	7.60
Gümüşhacıköy	1509	40.9000	35.2000	7.50
Amasya	1513	40.6500	35.8500	-
Amasya	1585	40.6500	35.8500	-
Amasya	1684	40.6500	35.8500	-
Amasya	1870	40.6500	35.8500	-
Amasya	1877	40.6000	36.0000	-
Tosya	1882	41.0000	34.0000	-
Kargı	1885	41.3000	34.3000	-

Tablo 1. KAFZ ve civarında gerçekleşen tarihsel depremler (Tan ve ark., 2008)

Tablo 1’de KAF’ nın orta segmentinde meydana gelmiş eski depremler yer almaktadır. KAF’ nın çeşitli kesimlerinde depremlerin tekrarlama aralıklarını belirlemek amacıyla paleosismik amaçlı hendek açma çalışmaları yapılmıştır (Rockwell ve ark., 2001;2009; Hartleb ve ark., 2003; Puchi, 2006; Pantosti ve ark., 2008; Palyvos ve ark., 2007). Paleosismolojinin amacı, sismik tehlike değerlendirmelerinde yeni ve faydalı bilgiler sağlayacak jeolojik ve jeomorfolojik özellikleri kullanarak geçmiş büyük depremlerin çalışılmasıdır. Aynı fay üzerinde tekrarlanan depremler ile meydana gelen toplam deformasyonun ve her bir depremin ayrı ayrı tanımlanması ve yaşlandırılması, fayın sismik davranışlarının belirlenmesine olanak sağlamaktadır.

### KAF Üzerinde Yapılan Paleosismik Çalışmalar

Bu bölümde KAF üzerinde çeşitli araştırmacılar tarafından yapılan Paleosismik Çalışmalar anlatılacaktır.

Çevresu hendekleri; Kürçer, A ve ark, 2008 tarafından 1942 Erbaa-Niksar depremine (M:6.9) ait fayın doğu ve orta kesimi arasında yer alan Erbaa-Niksar segmentinde açılan bu hendekte son 1300 yılda 1942 depremi de dahil olmak üzere üç adet yüzey faylanmasına ait izlere rastlandığı ifade edilmiştir.

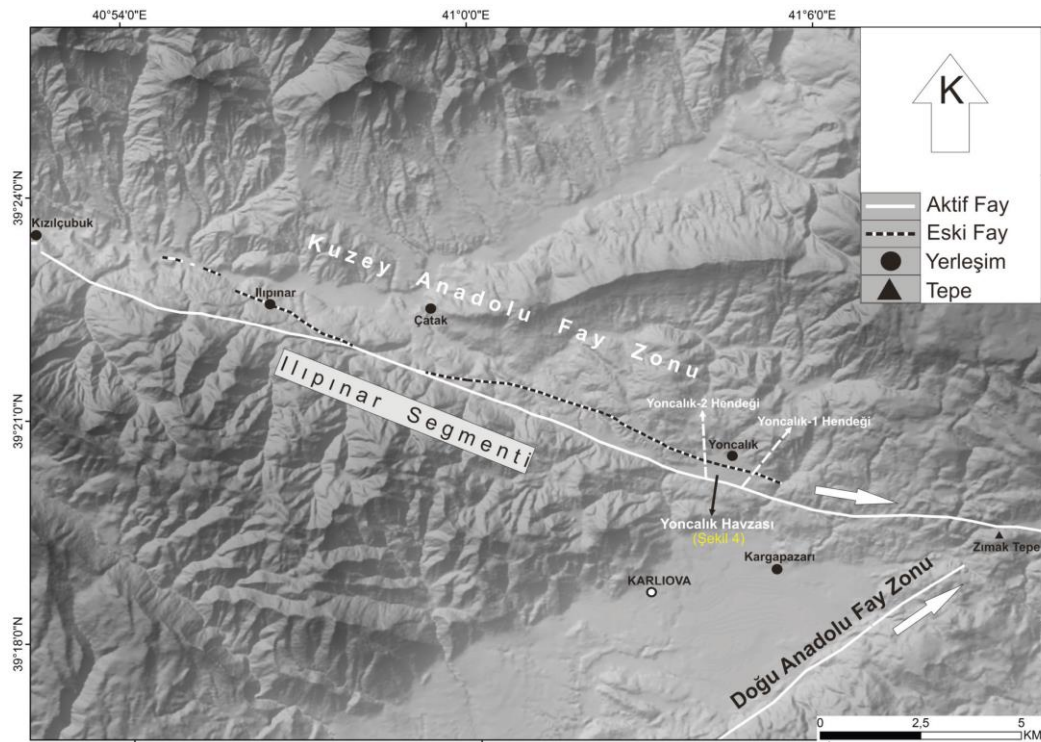
Aşağı yeniköy hendeği; Polat ve ark. (2012) tarafından açılan hendeklerden biri olan Aşağı Yeniköy hendeği, Akıncılar (Sivas) ilçesine bağlı Aşağı Yeniköy köyüne bağlı bir arazi üzerinde açılmıştır. Birbirine paralele yakın uzanan iki şev üzerinde birer adet açılan hendeklerden şevlerden daha güneyde olanı üzerinde faylanma kesilmiştir. Yine Aşağı Tepecik hendeğinde, Polat ve ark. (2012) tarafından Gölova (Sivas) ilçesine bağlı Aşağı Tepecik köy arazisinde açılmış olan hendekte 1939 Erzincan Depreminin meydana geldiği

## 4TH INTERNATIONAL LATIN AMERICAN CONGRESS ON NATURAL AND APPLIED SCIENCES

ana kırık tespit edilmiştir. Ayrıca buradan alınan örneklerin yaşlandırılmasına göre bu fay zone üzerinde Holosen boyunca tekrarlanan olaylara ait verilerde saptanmıştır.

Yoncalık-1 hendeği; Sançar ve Akyüz (2014) tarafından açılan Yoncalık-1 hendeğinde MÖ 5960-4300 tarihleri arasında meydana gelmiş olayın izine rastlanmıştır. Yine Sançar ve Akyüz (2014) tarafından açılan Yoncalık-2 hendeğindeki MÖ 6325 tarihinden önce olan deprem izinin Yoncalık-1 hendeğinde MÖ 8500-6150 arasında olan deprem ile aynı olduğu düşünülmektedir (Şekil-3).

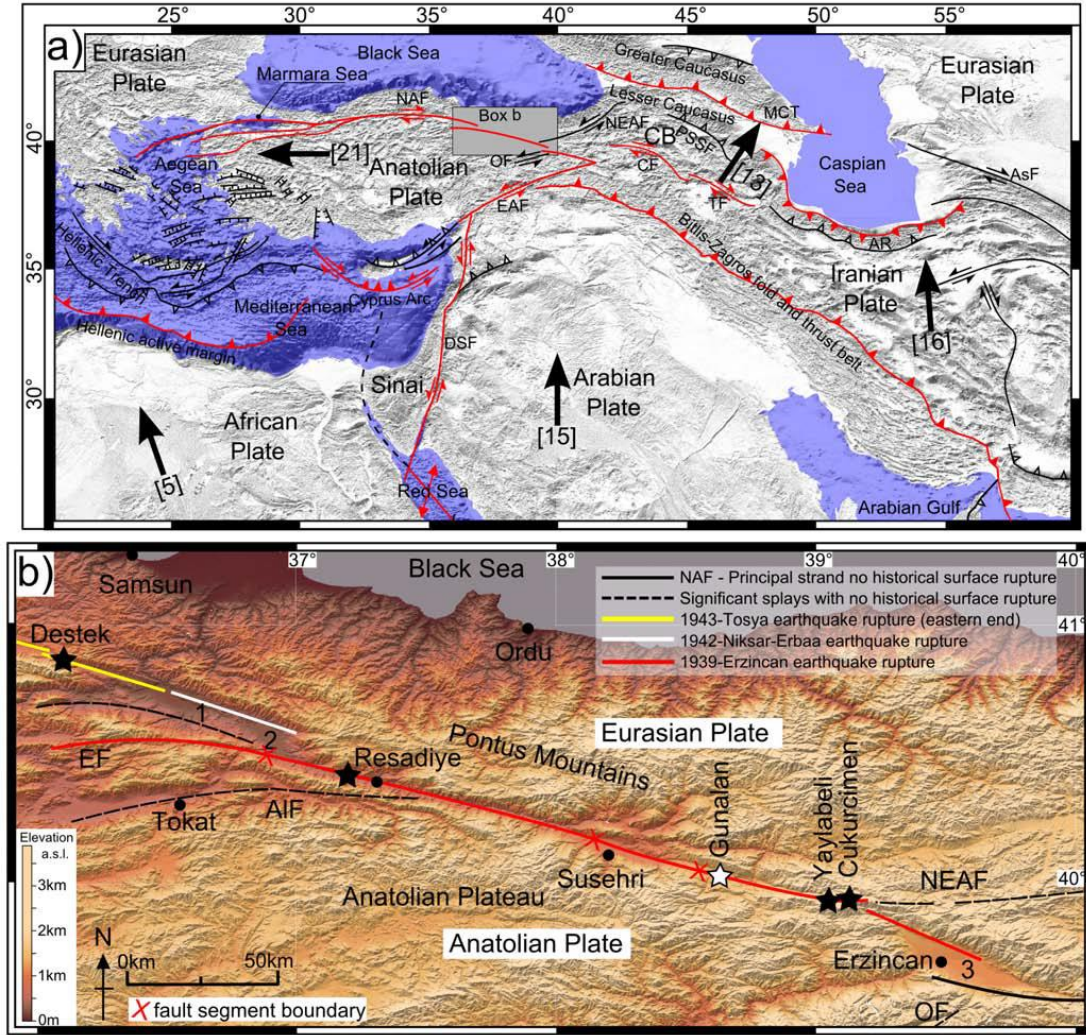
Kaynaşlı hendeği; Pantosti ve ark. (2008) tarafından Kaynaşlı' da açılan hendekten alınan örneklerden yaşları MS 685-890'a kadar değişen aralıkta deprem izlerine raslanmıştır. Pantosti ve ark. (2008) ayrıca Mengencik' de de hendek açarak paleosismoloji çalışması yapmışlardır.



Şekil-3. KAFZ'nin en doğu ucu olan Ilişınar Segmenti'nin geometrisi ve civarındaki diğer tektonik hatlar (Sançar, T ve Akyüz, S., 2014).

Bu bölgede birkaç adet hendek açarak çok sayıda örnek üzerinde yaşlandırmalar yapmışlardır. Bu araştırmalardan geçmiş tarihli birkaç olay tespit etmişlerdir. Pantosti ve ark. (2008) tarafından yapılan bir diğer paleosismik çalışma da Develi nehrine yakın bir kesimde ki Çakır Hacı İbrahim adıyla anılan hendekte olmuştur. Bu çalışmada araştırmacılar, MS 1488-1950 ve MS 1475-1660 dönemlerine ve daha genç yaşa sahip (MS 1680-1940) olaylara raslamışlardır.

Çakaloğlu hendeği; Ikeda ve ark. (1991) tarafından Adapazarı-Akyazı'nın 12 km GD' da açılan hendekte 22 Temmuz 1967 tarihli Mudurnu depreminin izini görmüşlerdir. Ayrıca hendekten alınan üç numunede göre günümüzden 150 yıl öncesine ait olay tespit etmişlerdir.



Şekil-4. (a) Bölgenin tektonik haritası, (a) KAF' nın doğusunun tektonik haritası üzerinde hendek noktaları (Fraser, Jeffrey George et al. (2013).

Yine Düzce fayı üzerinde Pantosti ve ark. (2008) tarafından açılan Çınarlı hendeğinde 1999 depreminin izine raslanmışlardır. Bu hendekten alınan numunelerin yaşlandırılması sonucu birkaç adet olaya raslanmışlardır. Ayrıca Aksu bölgesinde Pantosti ve ark. (2008) tarafından açılan hendekte 1999 depreminin izi açıkça görülmektedir. Bu hendekte de MS 1670' e ve MS 1880-1950 yıllarına tekabül eden olaylara ait kanıtlara ulaşılmıştır. Öte yandan, MS 890-1020 zaman aralığına ait bir olayda tanımlamışlardır.

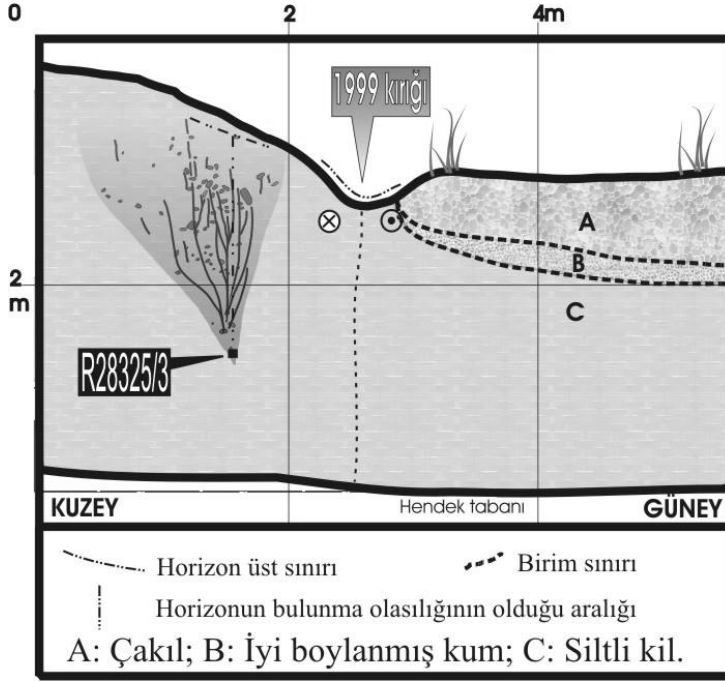
T1 hendeği; Fraser ve ark. (2013) tarafından KAF' nın doğusunda üç adet hendek çalışması yapmışlardır. T1 hendeğinde 1939 Erzincan depreminin izine raslanmıştır. Ayrıca Fraser ve ark. (2013) T2 hendeğinde yaş aralığı MS 1660' a tekabül eden bir olay tespit etmişlerdir. Yine Fraser ve ark. (2013) tarafından açılan T3 hendeğinde ise MS 1254 - MS 1391 aralığında bir olaya raslanmışlardır (Şekil-4).

Töngelli-1 hendeği; Düzce fayında Komut (2005) tarafından yapılan hendek çalışmasında 1999 depreminden önce gerçekleşmiş iki ayrı olaya ait kalıntılar ayırt edilmiştir. Komut



**4TH INTERNATIONAL LATIN AMERICAN  
CONGRESS ON NATURAL AND APPLIED SCIENCES**

(2005) tarafından Düzce fayında açılan Bend-1 hendeğinde M.S. 408-598 tarihli olaya raslanmıştır. Bend-3 hendeğinde ise Komut (2005) çalışmasında anlatıldığı üzere Bend-1'e yakın açılan bu hendekte MS 886-1021 tarihli olaya ait izlere raslanmıştır (Şekil-5)



Şekil-5. Bend-3 hendeği kesiti. 1999 depreminin izi ile diğer paleodepreme ait iz göze çarpmaktadır (Komut, 2005).

Zabcı ve ark. (2017) tarafından açılan Sarıkaya-2 hendeğinden alınan örneklerin yaşlandırma analizleri sonucu birkaç olaya ait tarihlemeler yapılmıştır.

Reşadiye hendeği; Zabcı ve ark. (2010) tarafından yapılan çalışmada 1939 depremine ait iz raslanmıştır. Ayrıca hendekten alınan örneklerde MÖ 2024-1742' ye ve MS 1423-1523 ile MS 893-1045 arasında değişen yaşlara ait olaylara rastlanmıştır.

## SONUÇLAR

Bu çalışma kapsamında KAF' da çeşitli araştırmacılar tarafından yapılan paleosismik çalışmalara göre, bölgedeki tarihsel depremlere ait olayların MÖ 5960 yılı ile başladığı anlaşılmaktadır. Aletsel dönemde ise KAF üzerinde aletsel büyüklüğü 6.0 ve daha büyük 21 deprem gözlenirken, aynı kriterlere göre DAF üzerinde gözlenen deprem sayısı 6 Şubat 2023 depremleri ile 8' e yükselmiştir. KAF' ı oluşturan segmentlerde çok sayıda tarihsel depremler belirlenmiştir. Özellikle 1419 Tosya M=7.6 ve 1509 Gümüşhacıköy M=7.5 depremlerinin büyüklüğünün de ifade edilmesi tarihsel deprem kayıtlarının önemini bir kez daha vurgulamaktadır. DAF' nı oluşturan segmentler üzerinde tarihsel dönemde meydana gelen önemli depremler; 1822 Antakya Depremi (Ms=7.5 yaklaşık 200 km yüzey kırığı

## **4TH INTERNATIONAL LATIN AMERICAN CONGRESS ON NATURAL AND APPLIED SCIENCES**

oluşturmuştur). 1866 Karlıova-BİNGÖL Depremi ( $M_s=7.2$  yaklaşık 45 km yüzey kırığı oluşturmuştur). 1872 Amik Gölü Depremi ( $M_s=7.2$  yaklaşık 20 km yüzey kırığı) 1874 ve 1875 Hazar Gölü Depremleri ( $M_s=7.1$  ve  $M_s=6.7$  45 ve 20 km yüzey kırığı) ve 1893 Malatya Depremi ( $M_s=7.1$ ) olarak verilebilir. KAF ve DAF birleşik (conjugate) faylardır. Bu tür fayların en tipik özelliği; biri aktif haldeyken diğersinin kilitlenmesidir. Dolayısı ile geçtiğimiz yüzyılda da KAF aktif haldeyken DAF'ın kilitlenmiş olduğu aletsel kayıtlardan anlaşılmıştır. Ancak 6 Şubat 2023 depremleri ile bu kilitlenmenin açıldığı ve Anadolu coğrafyasının hemen hemen her kırığının aktif hale geçebileceği öngörüsünde bulunabiliriz.

### **KAYNAKLAR**

- Akyüz, H. S., Hartleb, R., Barka, A., Altunel, E., Sunal, G., Meyer, B. and Armijo, R., 2002. Surface Rupture and Slip Distribution of the 12 November 1999 Duzce Earthquake (M 7.1), North Anatolian Fault, Bolu, Turkey, Bulletin of the Seismological Society of America, Vol. 92, no. 1, pp. 61-66.
- Ambraseys, N. N. 1989. "Temporary seismic quiescence: SE Turkey". Geophysical Journal. 96, 311-331
- Ambraseys, N. N. and Jackson, J., 1998. Faulting associated with historical and recent earthquakes in the Eastern Mediterranean region, Geophysical Journal International, Vol. 133, no. 2, pp. 390-406.
- Armijo, R., Meyer, B., Navarro, S., King, G. and Barka, A., 2002. Asymmetric slip partitioning in the Sea of Marmara pull-apart: a clue to propagation processes of the North Anatolian Fault, Terra Nova, Vol. 14, no. 2, pp. 80-86.
- Armijo, R., Pondard, N., Meyer, B., Uçarkus, G., Lepinay, B. M. d., Malavieille, J., Dominguez, S., Gustcher, M.-A., Schmidt, S., Beck, C., Çagatay, N., Çakir, Z., Imren, C., Eriş, K., Natalin, B., Özalaybey, S., Tolun, L., Lefevre, I., Seeber, L., Gasperini, L., Rangin, C., Emre, O. and Sarikavak, K., 2005. Submarine fault scarps in the Sea of Marmara pullapart (North Anatolian Fault): Implications for seismic hazard in Istanbul, Geochemistry Geophysics Geosystems, Vol. 6, p. Q06009.
- Aydın, A. and Kalafat, D., 2002. Surface Ruptures of the 17 August and 12 November 1999 Izmit and Duzce Earthquakes in Northwestern Anatolia, Turkey: Their Tectonic and Kinematic Significance and the Associated Damage, Bulletin of the Seismological Society of America, Vol. 92, no. 1, pp. 95-106.
- Barka, A., Akyuz, H. S., Altunel, E., Sunal, G., Cakir, Z., Dikbas, A., Yerli, B., Armijo,

**4TH INTERNATIONAL LATIN AMERICAN  
CONGRESS ON NATURAL AND APPLIED SCIENCES**

R., Meyer, B., de Chabaliér, J. B., Rockwell, T., Dolan, J. R., Hartleb, R., Dawson, T., Christofferson, S., Tucker, A., Fumal, T., Langridge, R., Stenner, H., Lettis, W., Bachhuber, J. and Page, W., 2002. The Surface Rupture and Slip Distribution of the 17 August 1999 Izmit Earthquake (M 7.4), North Anatolian Fault, Bulletin of the Seismological Society of America, Vol. 92, no. 1, pp. 43-60.

Beyhan, G., Selim, H.H., Özçiçek, B., 2009. Tectonics related to the North Anatolian Fault in the Sea of Marmara: evidence from seismic reflection data. Mar Geophys Res. 30:237–250

Bouchon, M., Toksöz, M. N., Karabulut, H., Bouin, M.-P., Dietrich, M., Aktar, M. and Edie, M., 2002. Space and Time Evolution of Rupture and Faulting during the 1999 Izmit (Turkey) Earthquake, Bulletin of the Seismological Society of America, Vol. 92, no. 1, pp. 256-266.

Çetin H., Güneyli, H. And Mayer, L. 2003. Paleoseismology of the Palu-Lake Hazar segment of the East Anatolian Fault Zonme, Turkey. Tectonophysics 374, 163-197.

Duman, T.Y., Emre, Ö. 2013. The East Anatolian Fault: geometry, segmentation and jog characteristics. Geol. Soc. (London) Spec. Publ., 372, 495-529.

Emre Ö, Duman TY, Özalp S, Elmacı H, Olgun Ş, Şaroğlu F. 2013 Active fault map of Turkey with an explanatory text. 1:1,250,000 scale; General Directorate of Mineral Research and Exploration, Special Publication Series-30 Ankara-Turkey, ISBN: 978–605–5310–56.

Fraser, Jeffrey George et al. (2013). A 3000-year record of surface-rupturing earthquakes at Günelan: variable fault-rupture lengths along the 1939 Erzincan earthquake-rupture segment of the North Anatolian Fault, Turkey. Annals of Geophysics, [S.I.], v. 55, n. 5, jan. 2013. ISSN 2037-416X.

Gazioğlu, C., Gökaşan, E., Algan, O., Yücel, Z., Tok, B. and Doğan, E., 2002.

Morphologic features of the Marmara Sea from multi-beam data, Marine Geology, Vol. 190, no. 1-2, pp. 397-420.

Hartleb, R. D., Dolan, J. F., Akyuz, H. S. ve Yerli, B. (2003). A 2000-year-long paleoseismologic record of earthquakes along the central North Anatolian Fault, from trenches at Alayurt, Turkey. Bulletin of the Seismological Society of America 93, 1935-1954.

Hartleb, R. D., Dolan, J. F., Akyuz, H. S., Dawson, T. E., Tucker, A. Z., Yerli, B.,

Rockwell, T. K., Toraman, E., Cakir, Z., Dikbas, A. and Altunel, E., 2002. Surface Rupture and Slip Distribution along the Karadere Segment of the 17 August 1999 Izmit and the Western Section of the 12 November 1999 Duzce, Turkey, Earthquakes, Bulletin of the Seismological Society of America, Vol. 92, no. 1, pp. 67-78.

Ikeda Y. Suzuki Y Herece E. Saroglu R Isikara A.M. Honkura Y., 1991. Geological



**4TH INTERNATIONAL LATIN AMERICAN  
CONGRESS ON NATURAL AND APPLIED SCIENCES**

evidence for the last two faulting events on the North Anatolian fault zone in the Mudurnu Valley, western Turkey, *Tectonophysics* , 193, 335–345.

İmren, C., Le Pichon, X., Rangin, C., Demirbag, E., Ecevitoglu, B. and Görür, N.,

2001. The North Anatolian Fault within the Sea of Marmara: a new interpretation based on multi-channel seismic and multi-beam bathymetry data, *Earth and Planetary Science Letters*, Vol. 186, no. 2, pp. 143-158.

Komut, T.2005. "Düzce Fayı Eski Deprem Olaylarının Stratigrafik ve Yapısal

Kanıtları.", *Türkiye Kuvaterner Sempozyumu (TURQUA), İSTANBUL, TÜRKİYE, 2-5 Haziran 2005, cilt.V, ss.48-54*

Le Pichon, X., Rangin, N., Chamot-Rooke, C. and Şengör, A. M. C., 2003. The North Anatolian fault in the Sea of Marmara, *Journal of Geophysical Research*, Vol. 108, no. B4, pp. 2179-2179.

Le Pichon, X., Şengör, A. M. C., Demirbağ, E., Rangin, C., Imren, C., Armijo, R.,

Görür, N., Çağatay, N., Mercier de Lepinay, B. and Meyer, B., 2001. The active Main Marmara Fault, *Earth and Planetary Science Letters*, Vol. 192, no. 4, pp. 595-616.

Palutoğlu, M , Şaşmaz, A . 2017. 29 November 1795 Kahramanmaraş Earthquake,

Southern Turkey. *Bulletin of the Mineral Research and Exploration*, 155 (155) ,187-202 . DOI: 10.19111/bulletinofmre.314211

Palyvos, N., Pantosti, D., Zabcı, C. and D'Addezio, G., 2007. Paleoseismological

Evidence of Recent Earthquakes on the 1967 Mudurnu Valley Earthquake Segment of the North Anatolian Fault Zone, *Bulletin of the Seismological Society of America*, Vol. 97, no. 5, pp. 1646-1661.

Pantosti, D., Pucci, S., Palyvos, N., De Martini, P. M., D'Addezio, G., Collins, P. E. F.

and Zabcı, C., 2008. Paleoeearthquakes of the Duzce fault (North Anatolian Fault Zone): Insights for large surface faulting earthquake recurrence, *Journal of Geophysical Research*, Vol. 113, no. B01309.

Pınar, A., Honkura, Y. and Kuge, K., 2001. Seismic activity triggered by the 1999

Izmit earthquake and its implications for the assessment of future seismic risk, *Geophysical Journal International*, Vol. 146, no. 1, pp. F1-F7.

Polat, A , Tatar, O , Gürsoy, H , Karabacak, V , Zabcı, C , Sançar, T . (2012). 1939

Erzincan Depremi Yüzey Kırığının Ortaköy-Suşehri Segmenti Üzerinde Paleosismolojik Bulgular, *Kuzey Anadolu Fay Zonu. Türkiye Jeoloji Bülteni* , 55 (3) , 137-158 . Retrieved from

Pucci, S., Palyvos, N., Zabcı, C., Pantosti, D. ve Barchi, M. (2006). Coseismic ruptures

**4TH INTERNATIONAL LATIN AMERICAN  
CONGRESS ON NATURAL AND APPLIED SCIENCES**

and tectonic landforms along the Düzce segment of the North Anatolian Fault Zone (Ms 7.1, November 1999), *Journal of Geophysical Research*, 111, B06312-B06312.

Reilinger, R. E., McClusky, S. C., Oral, M. B., King, R. W., Toksöz, M. N., Barka, A.

A., Kınık, I., Lenk, O. and Şanlı, I., 1997. Global Positioning System measurements of present-day crustal movements in the ArabiaAfrica-Eurasia plate collision zone, *Journal of Geophysical Research*, Vol. 102, no. B5, pp. 9983–9999.

Reilinger, R. E., McClusky, S., Vernant, P., Lawrence, S., Ergintav, S., Cakmak, R.,

Özener, H., Kadirov, F., Guliev, I., Stepanyan, R., Nadariya, M., Hahubia, G., Mahmoud, S., Sakr, K., ArRajehi, A., Paradissis, D., AlAydrus, A., Prilepin, M., Guseva, T., Evren, E., Dmitrova, A., Filikov, S. V., Gomez, F., Al-Ghazzi, R. and Karam, G., 2006. GPS constraints on continental deformation in the Africa-Arabia-Eurasia continental collision zone and implications for the dynamics of plate interactions, *Journal of Geophysical Research*, Vol. 111, no. B05411.

Rockwell, T. K., Lindvall, S., Dawson, T., Langridge, R., Lettis, W. and Klinger, Y.,

2002. Lateral Offsets on Surveyed Cultural Features Resulting from the 1999 Izmit and Duzce Earthquakes, Turkey, *Bulletin of the Seismological Society of America*, Vol. 92, no. 1, pp. 79-94.

Rockwell, T., Barka, A., Dawson, T., Akyüz, S., Thorup, K. 2001. *Journal of Seismology* 5: 433 <https://doi.org/10.1023/A:1011435927983>.

Rockwell, T., Regona, D., Seitz, G., Langridge, R., Aksoy, M.E., Uçarkuş, G., Ferry,

M., Meltzner, A.J., Meghraoui, M., Satır, D., Barka, A., Akbalık, B. 2009. Palaeoseismology of the North Anatolian Fault near the Marmara Sea: Implications for fault segmentation and seismic hazard, in *Palaeoseismology: Historical and Prehistorical Records of Earthquake Ground Effects for Seismic Hazard Assessment*, edited by K. Reicherter, A. M. Michetti, and P. G. Silva. *Geol. Soc. Spec. Publ.*, 316(1), 31–54.

Sançar, T ve Akyüz, S., 2014. Kuzey Anadolu Fay Zonu, Ilıpınar Segmenti'nin

(Karlıova, Bingöl) Paleosismolojisi-Paleoseismology of the Ilıpınar Segment (Karlıova, Bingöl), *The North Anatolian Fault Zone. Türkiye Jeoloji Bülteni*. Cilt 57, Sayı 2, Nisan 2014.

Sekiguchi, H. and Iwata, T., 2002. Rupture Process of the 1999 Kocaeli, Turkey,

Earthquake Estimated from Strong-Motion Waveforms, *Bulletin of the Seismological Society of America*, Vol. 92, no. 1, pp. 300-311.

Tan, O., Tapırdamaz, M. C. ve Yoruk, A. (2008). The earthquake catalogues for Turkey. *Turkish Journal of Earth Sciences* 17, 405-418.

Tibi, R., Bock, G., Xia, Y., Baumbach, M., Grosser, H., Milkereit, C., Karakisa, S.,

**4TH INTERNATIONAL LATIN AMERICAN  
CONGRESS ON NATURAL AND APPLIED SCIENCES**

Zunbul, S., Kind, R. and Zschau, J., 2001. Rupture processes of the 1999 August 17 Izmit and November 12 Düzce (Turkey) earthquakes, *Geophysical Journal International*, Vol. 144, no. 2, pp. F1-F7.

Uçarkuş, G., Armijo, R., Çakır, Z., Schmidt, S. and Meyer, B., 2008. Recent

Earthquake Breaks at the Sea of Marmara Pull-apart (North Anatolian Fault), *Eos Trans. AGU San Francisco*, 15-19 December,

Uçarkus, G., Armijo, R., Pondard, N., Meyer, B. and Çakir, Z., 2006. The Eastern

Marmara pull-apart junction (North Anatolian Fault) and its relation to the submarine end of the 1999 Izmit earthquake rupture, *Geophysical Research Abstracts*, 08807-08807.

Zabcı C, Akyüz HS, Sançar T (2017) Paleoseismic history of the eastern part of the

North Anatolian Fault (Erzincan. Implications for the seismicity of the Yedisu Seismic Gap. *J Seismol*, Turkey). <https://doi.org/10.1007/s10950-017-9673-1>.

**INVESTIGATION OF THE RELATIONSHIP BETWEEN KAPPA-CASEIN GENE  
POLYMORPHISM AND MILK PRODUCTION CHARACTERISTICS IN HOLSTEIN  
BREED CATTLE: META-ANALYSIS**

**Memiş Özdemir**

Prof. Dr., Atatürk Üniversitesi

ORCID: 0000-0002-1301-0270

**Zekrullah Motmain**

Atatürk Üniversitesi

ORCID: 0000-0003-3644-1054

**Kübra Ekinci**

Arş. Gör., Atatürk Üniversitesi

ORCID: 0000-0002-0877-1358

**Esratur Saygılı**

Atatürk Üniversitesi

ORCID: 0000-0002-9701-1544

**ABSTRACT**

Meta-Analysis is defined as the collection of analyses or top analysis when it is considered as the meaning of the word. Meta-analysis is a statistical analysis method in which the results of many independent studies conducted on a specific topic are evaluated together. This study aims to investigate the relationship of Kappa-Casein (CSN3) gene polymorphism with lactation milk yield, fat yield, and protein yield in Holstein breed cattle. For this purpose, the Meta-Analysis method was used. All databases reached for the study were searched by using appropriate keywords to cover the years 2002-2022, taking into account all national and international studies. Data were obtained by examining 15 studies for lactation milk yield, 10 studies for fat yield, and 9 studies for protein yield that meets the research criteria. Statistical

analyses were performed using the Stata 11.2 software program. Codominant (AB versus AA, BB versus AA, and BB versus AB), dominant (AA+AB - BB), and recessive (AB+BB versus AA) were used as inheritance models. As a result of the study, the relationship between CSN3 gene polymorphism and lactation milk yield and protein yield was found to be insignificant ( $p>0.05$ ), while the relationship between CSN3 gene polymorphism and fat yield (AA versus AB and AB versus BB) was significant (respectively  $p<0.05$  and  $p<0.01$ ).

**Keywords:** Kappa-Casein, Meta-Analysis, Polymorphism, Holstein

## **1. INTRODUCTION**

The homeland of Holstein breed, which originated from cattle raised in the lowlands on the North Sea coasts of the Netherlands, Germany, and Denmark, is the most common cattle breed in the world. The yields of the Holstein breed, especially milk, have been increased to levels that other cattle breeds cannot compete with it (Daşkaya, 2007).

A large percentage of the protein consumed daily in developed countries is obtained from animal products, and more than half of the total agricultural income in these countries were provided by animals (Grandin, 2000). Milk is one of the basic animal products, has been taken from animals such as cows, sheep, goats, horses, buffaloes, or camels and used in the daily diet since the transition of humanity from hunter/gatherer to farming about 8000-10000 years ago (Scholz-Ahrens et al., 2020). Protein, fat, carbohydrates, vitamins, and minerals, which are biochemical substances that play an important role in human nutrition, are present at significant levels in milk (Kliem et al. 2013). However, the milk content is affected by many factors. The milk content is specific to the species, and there are also differences in the content of milk produced in different geographies (Göncü et al., 2022).

Caseins, which are one of the milk proteins and constitute 80% of milk proteins, consist of  $\alpha$ S1-,  $\alpha$ S2-,  $\beta$ - and  $\kappa$ -casein (Fox and Brodtkorb 2008; Eigel et al., 1984). Kappa casein ( $\kappa$ -casein, CSN3) has a polypeptide chain consisting of 169 amino acids (Swaisgood, 1975). It encodes milk proteins that are important for the balance and structure of casein micelles (Alexander et al., 1988). It constitutes approximately 13% of milk caseins (Farrell et al., 2004). Studies on  $\kappa$ -casein have allowed the characterization and comparison of different breeds of

cattle in terms of milk yield. Therefore,  $\kappa$ -casein has aroused great interest as a genetic marker and has been accepted as a quantitative character locus (QTL) (Comin et al., 2008; Caroli et al., 2009). Today's molecular genetic technologies make it possible to use genetic markers or characters that show a high correlation with the characteristics focused on for the determination of high-yielding animals, which can be detected at an early stage and regardless of gender. In this way, it is possible to make fast, economical, and more accurate selections in breeding studies. (Özdemir, 2008).

Today, as in every field, the number of scientific studies in the field of animal husbandry is increasing rapidly. Now it is possible to come across quite a large number of studies that have been conducted independently of each other on any subject of any field and have reached different results from each other. Examining all these sources, reviewing their findings, and taking their results and suggestions into account requires a reader to spare days or even months, making it very difficult to reach the desired information in this abundance of information. To organize this information under a single roof, pass it through an analysis process, and reach new interpretations and decisions, Glass (1976) suggested the method of re-summarizing the research findings and gathering them under a single research roof and called the method "meta-analysis". At the same time, the meta-analysis study also provides important information about whether the results observed in individual studies are a sign of chance. Thus, by increasing the sample size, the statistical significance level of the study is also increased (Sağlam & Yüksel, 2007).

This study aims to reveal the relationship between kappa-casein gene polymorphisms, which is one of the genes effective in milk yield, and some milk yield characteristics by meta-analysis method.

## **2. MATERIAL AND METHOD**

For existing studies on CSN3 gene polymorphism and their relationship between lactation milk yield, fat yield, and protein yield characteristics in Holstein cattle, Google Scholar, ResearchGate, Wiley, Springer, Taylor & Francis, PubMed, and Elsevier databases were searched for the years 2002-2022. Appropriate keywords were determined for the research (meta-analysis, milk production characteristics, polymorphism, PRL, association, cattle) and a search was made considering all national and international studies. Data were obtained by



**4TH INTERNATIONAL LATIN AMERICAN  
CONGRESS ON NATURAL AND APPLIED SCIENCES**

examining 15 studies for lactation milk yield, 10 studies for milk fat yield, and 9 studies for milk protein yield that meet the research criteria. The data were organized by taking the author's name, year of publication, country, sample size, genotypes, breed, lactation milk yield (LMY), protein yield, and fat yield from the collected studies. Statistical analyzes were performed using the Stata 11.2 software program. Only the Holstein breed was included in the study to ensure the difference between the breeds and the genotype x environment interaction in a homogeneous way. Two effect models (random and fixed) were used in the meta-analysis. Also, four genetic patterns: dominant; AA + AB versus BB, recessive; AA vs AB + BB, co-dominant; AA versus BB versus AB models were used. Standardized mean differences (SMDs) and standard deviation were calculated at 95% CI (Confidence Interval) to estimate abilities between the three genetic models for each trait. For standardized mean differences, Cohen's method was used to evaluate the effect size.

### 3. RESULTS AND DISCUSSION

In the present study three productive traits (lactation milk yield, fat and protein yield) were investigated. Table 1 contains the statuses of the heritage pattern of alleles with the results for heterogeneity, standardized mean difference (SMD) with a 95% CI, and significances.

Table 1. Genetics models analysis of the association between CSN3 gene polymorphism and milk production traits.

Traits	n	AA Versus AB						AA Versus BB						AB Versus BB					
		I <sup>2</sup>	mode l	SM D	90%	CI	P	I <sup>2</sup>	mode l	SM D	90%	CI	P	I <sup>2</sup>	mode l	SM D	90%	CI	P
Lactation milk yield	8	97.6*	R	-0.045	-0.097	0.907	0.927	94.5*	R	-0.558	-1.375	0.258	0.180	97.9*	R	-0.17	-1.038	0.698	0.701
Fat yield	6	98**	R	0.501	-0.421	1.422	0.287	91.6*	R	0.151	-0.844	0.542	0.669	98.0*	R	-0.696	-1.544	0.152	0.108
Protein yield	6	98.3*	R	0.276	-0.749	1.301	0.598	92.7*	R	-0.496	-1.236	0.245	0.189	98.1*	R	0.463	-1.323	0.398	0.292

\* P<0.10; \*\* P<0.01; n: number of publication; I<sup>2</sup>: variation in SMD attributable to heterogeneity; F: Fixed; R: Random

When the results of 15 studies were analyzed, the relationship between lactation milk yield and all CSN3 genetic models was found to be statistically insignificant ( $P>0.05$ ). Similar results were found in studies by Gürses et al., (2016); Kaygısız and Dogan, (1999); and Safina et al., (2021). When the statistical analysis was performed with a meta-analysis of 10 studies examining the relationship between fat yield and CSN3 genetic models (AA vs. AB and AB vs. BB), the relationship between them was found to be significant ( $P<0.05$ ). According to the statistical analysis results, the relationship between AA versus BB and individuals was not significant. The results of this study are consistent with the findings obtained by Alipanah et al. (2005); Safina et al. (2021). However, Chung et al (2005), Zhang et al (2007), Vidovic et al (2013), and Gürses et al (2016) contradict the studies. In the analysis of 9 studies that met the appropriate criteria, the relationship between protein yield and all CSN3 genetic models were found to be statistically insignificant ( $P>0.05$ ). The results of the studies performed by Zhang et al (2007) Vidovic et al (2013) Safina et al (2021) are in line with the studies conducted by Semerci et al (2022) while contradicting the study by Chung et al. (2005).

## **5. CONCLUSION**

As a result, studies conducted between 2002-2022 on the relationship between CSN3 gene polymorphisms and milk yield characteristics in Holstein cattle and meeting certain criteria were reviewed. As a result of the meta-analysis, a significant correlation was found between CSN3 genotypes and fat yield, and BB genotypes followed by AA and BB genotypes showed successively higher values compared to other genetic models. In addition, the relationship between lactation milk yield and protein yield, and CSN3 gene polymorphisms were found insignificant.

## **References**

- Scholz-Ahrens, K. E., Ahrens, F., & Barth, C. A. (2020). Nutritional and health attributes of milk and milk imitations. *European journal of nutrition*, 59, 19-34.
- Grandin, T. (2000). Livestock handling and transport. CABI Publ. Wallingford Oxon, UK.
- Kliem, K. E., Shingfield, K. J., Livingstone, K. M., & Givens, D. I. (2013). Seasonal variation in the fatty acid composition of milk available at retail in the United Kingdom and implications for dietary intake. *Food Chemistry*, 141(1), 274-281.
- Göncü, S., Gökçe, G., & Yeşil, M. I. (2022). Akdeniz İklim Koşullarında Mevsimin İnek, Koyun ve Keçi Süt Kompozisyonu Üzerine Etkisi. *Kadirli Uygulamalı Bilimler Fakültesi Dergisi*, 2(2), 230-243.

**4TH INTERNATIONAL LATIN AMERICAN  
CONGRESS ON NATURAL AND APPLIED SCIENCES**

- Daşkaya, A. (2007). Özel Bir Damızlık İşletmesinde Yetiştirilen Holstein Ineklerin Döl ve Süt Verimi Özellikleri (Doctoral dissertation, Bursa Uludağ University (Turkey)).
- Swaisgood, H. (1975). The primary sequence of kappa-casein. *Journal of dairy science*, 58(4), 583-592.
- Alexander LJ, Stewart AF, Mackinlay AG, Kapelinskaya TV, Tkach TM, Gorodetsky SI. (1988) Isolation and characterization of the bovine k-casein gene. *Eur J Biochem*. 1988;178(2):395-401.
- Farrell Jr, H. M., Jimenez-Flores, R., Bleck, G. T., Brown, E. M., Butler, J. E., Creamer, L. K.,... & Swaisgood, H. E. (2004). Nomenclature of the proteins of cows' milk sixth revision. *Journal of dairy science*, 87(6), 1641-1674.
- Özdemir, M., & Dođru, Ü. (2008). Sığırların verim özellikleri üzerine etkili önemli moleküler markörler. *Atatürk Üniversitesi Ziraat Fakültesi Dergisi*, 39(1), 127-135.
- Comin, A., Cassandro, M., Chessa, S., Ojala, M., Dal Zotto, R., De Marchi, M., & Bittante, G. (2008). Effects of composite  $\beta$ - and  $\kappa$ -casein genotypes on milk coagulation, quality, and yield traits in Italian Holstein cows. *Journal of dairy science*, 91(10), 4022-4027.
- Caroli, A. M., Chessa, S., & Erhardt, G. J. (2009). Invited review: Milk protein polymorphisms in cattle: Effect on animal breeding and human nutrition. *Journal of dairy science*, 92(11), 5335-5352.
- Sađlam, M., & Yüksel, İ. (2007). Program deđerlendirmede meta-analiz ve meta deđerlendirme. *Dumlupınar Üniversitesi Sosyal Bilimler Dergisi*, (18)
- Fox, P. F., & Brodtkorb, A. (2008). The casein micelle: Historical aspects, current concepts and significance. *International dairy journal*, 18(7), 677-684.
- Eigel, W. N., Butler, J. E., Ernstrom, C. A., Farrell Jr, H. M., Harwalkar, V. R., Jenness, R., & Whitney, R. M. (1984). Nomenclature of proteins of cow's milk: fifth revision. *Journal of dairy science*, 67(8), 1599-1631.
- Glass, G. V. (1976). Primary, secondary, and meta-analysis of research. *Educational researcher*, 5(10), 3-8.
- Sađlam, M., & Yüksel, İ. (2007). Program deđerlendirmede meta - analiz ve meta-deđerlendirme. *Dumlupınar Üniversitesi Sosyal Bilimler Dergisi*, (18).
- Gurses M, Yuce H, Etem EO, Bahri P (2016) Polymorphisms Of Kappa-Casein Gene And Their Effects On Milk Production Traits In Holstein, Jersey, And Brown Swiss Cattle. *Animal Production Science*. 53:778-784.
- Kaygısız A, Dogan M (1999) Genetics of Milk Protein Polymorphism and its Relation to Milk Yield Traits in Holstein Cows. *Turkish Journal of Veterinary and Animal Sciences*. 23:447-454.
- Safina N, Yu, Gaynutdinova ER, Shakirov SK, (2021) Dairy Productivity Of Holstein Cattle With Different Genotypes Of The Kappa-Casein Gene (CSN3). *Agrarın Sientific*. 10:93-97. <https://doi.org/10.28983/asj.y2021i10pp93-97>
- Alipanah M, Kalashnikova L, Rodionov, G (2005) Kappa-Casein Genotypic Frequencies In Russian Breeds Black And Red Pied Cattle. *Iranian Journal Of Biotechnology*. 3:191-194.
- Chung ER, Chung K Y (2006) Association Of B-Lactoglobulin Variants With Milk Yield And

**4TH INTERNATIONAL LATIN AMERICAN  
CONGRESS ON NATURAL AND APPLIED SCIENCES**

- Composition In Dairy Cattle. Korean J Food Sci. Ani Resour. 26: 121-126.
- Zhang J L, Zan LS, Fang P, Zhang F, Shen G, Tian WQ, (2007) Genetic Variation Of PRLR Gene  
And Association With Milk Performance Traits In Dairy Cattle. Can. J Anim Sci. 88:33-39.  
<https://doi.org/10.4141/CJAS07052>
- Vidovic V, Nemes Z, Popović-Vranjes A, Lukac A, Cvetanovic D, strbac L, Stupar M (2013)  
Heritability and correlations of milk traits in the view of kappa-casein genotypes in  
Vojvodina  
Holstein-Friesian dairy cattle. Mljekarstvo / Dairy 63: 91-97.
- Semerci ES, Balcioglu MS (2022) The Effects Of K-Casein, B- Lactoglobulin, Prolactin And  
DGAT1  
Polymorphisms on Milk Yields In Turkish Holstein Cows. Turk J Vet Anim Sci. 46:9-  
17.  
<http://doi.org/10.3906/vet-2105-10>